



DENTAL
INSTRUMENTS CATALOGUE

Introduction

Creating the Future of Instruments

Products Quality

What sets our Products apart from the competition?

Our products are different from others in the following manner.

Quality: They will comply the exact specification provided by the customer.

Function: Our products always perfect for the function they are made for.

Feature: We carry out all the necessary tests, inspections and process control activities to ensure that there is no problem with the products. We will also give the technical specifications to improve the confidence of the customer.

Reliability : We give our customer the guarantee that there our Products are reliable in use even after using it up till extended period of time. Our Products will perform their function efficiently more than any other product of similar nature in the market.

Where our Products are made are made? All the Products are made in our own facility by the workers who are best in their workmanship, and commitment.

MEMBER



ایوان صنعت و تجارت سیالکوٹ





Table of Contents













01	Tooth Extracting Forceps	01-49	
02	Root Elevators	50-70	
03	Scalpel Handles, Handles, Mouth Mirrors Scalers, Explorer / Probes	71-85	
04	Endodontic Condensers, Obturation Instruments Excavators, Explorer / Probes, Curette Sets	86-96	
05	Amalgam Pluggers / Condensers, Burnishers	97-100	
06	Wax Carvers, Carvers, Chisels	101-103	
07	Compote Placement, Plastic Filling Instruments	104-107	
08	Curettes, Gracey Curettes, Dental Products, Knives	108-117	
09	Wax Porcelain & Cement Instruments Wax & Modeling Instruments	118-121	
10	Spatulas, Cement Spatulas	122-124	
11	Files, Hoes, Knives, Wax & Plaster Knives, Crane Kaplan	125-128	
12	Bone Curettes, Bone Files, Bone Chisels, Bone Mallets	129-133	
13	Crown Removers, Crown Instruments	134-136	



Table of Contents

14	Implants & Measuring Instruments, Suction Tubes, Bone Gauges	137-144	██████████
15	Amalgam Guns & Carriers, Retainers, Bands, Strip Holders, Napkin Holders	145-146	██████████
16	Rubber Dam Instruments, Rubber Dam Clamps	147-148	██████████
17	Syringes, Tweezers, Sterilizing & Lab Instruments	149-156	██████████
18	Endodontic Forceps, Tissue Forceps, Haemostatic Forceps, Towel Clamps	157-159	██████████
19	Retractors, Lip & Cheek Retractors, Hooks, Depressors & Mouth Gags, Sterilizing Forceps	160-164	██████████
20	Orthodontic Pliers & Cutters, Rongeurs	165-179	██████████
21	Needle Holders, Scissors, Micro Surgery Set	180-186	██████████
22	Impression Trays	187-193	██████████
23	Articulators, Hollow Wares	194-200	██████████
24	Scissors, Dissecting Forceps, Needle Holders, Wire Cutting Pliers With Tungsten Carbide Inserts	201-213	██████████
25	Dental Implants Instruments	214-216	██████████
26	Dental Instruments Sets	217	██████████



Extracting Forceps "English Pattern"



1001
Fig. 4
lower incisor



1001
Fig. 4
lower incisor



1002
Fig. 8
lower premolar



1002
Fig. 8
lower premolars



Extracting Forceps "English Pattern"



1003
Fig. 1
upper centrals & canines



1004
Fig. 2
upper laterals & canines



1005
Fig. 3
upper incisors & canines



1006
Fig. 4
upper incisors & canines

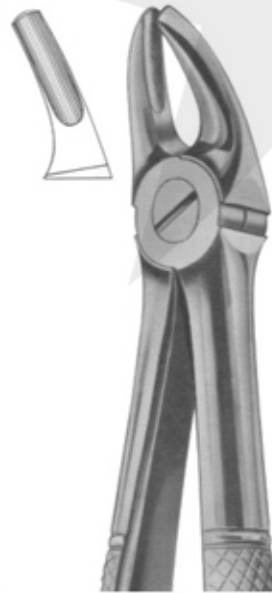

1007
Fig. 7
upper premolars

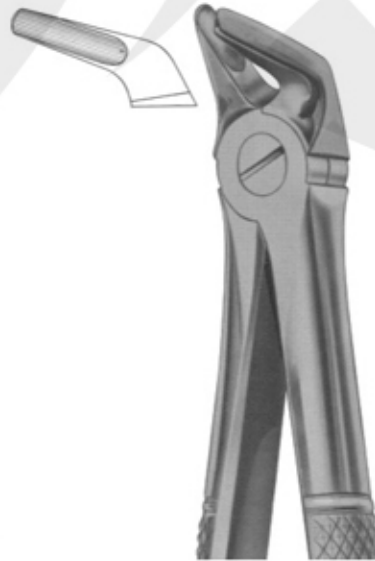

1008
Fig. 8
lower premolars



1009
Fig. 13
lower premolars



Extracting Forceps "English Pattern"



1010
Fig. 13S
lower premolars
for children.

1011
Fig. 17
upper molars, right

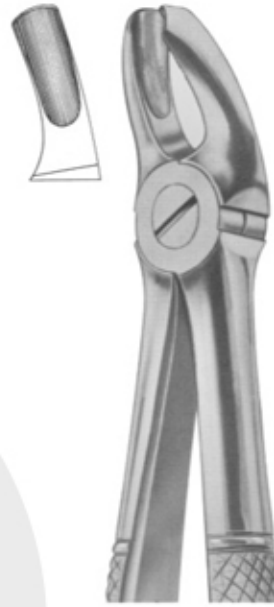

1012
Fig. 18
upper molars, left

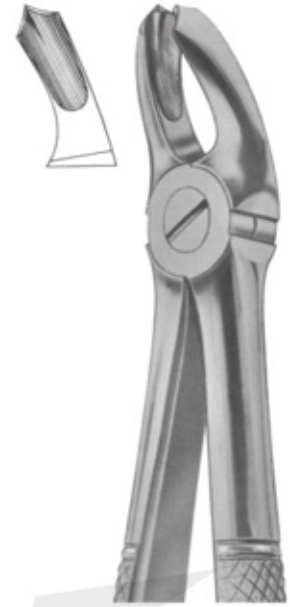

1013
Fig. 18A
upper molars

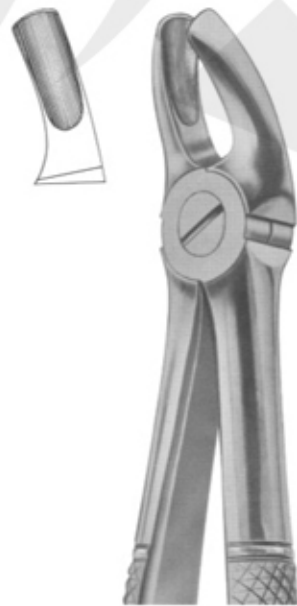

1014
Fig. 18B
upper molars



1015
Fig. 19
upper third molars



Extracting Forceps "English Pattern"

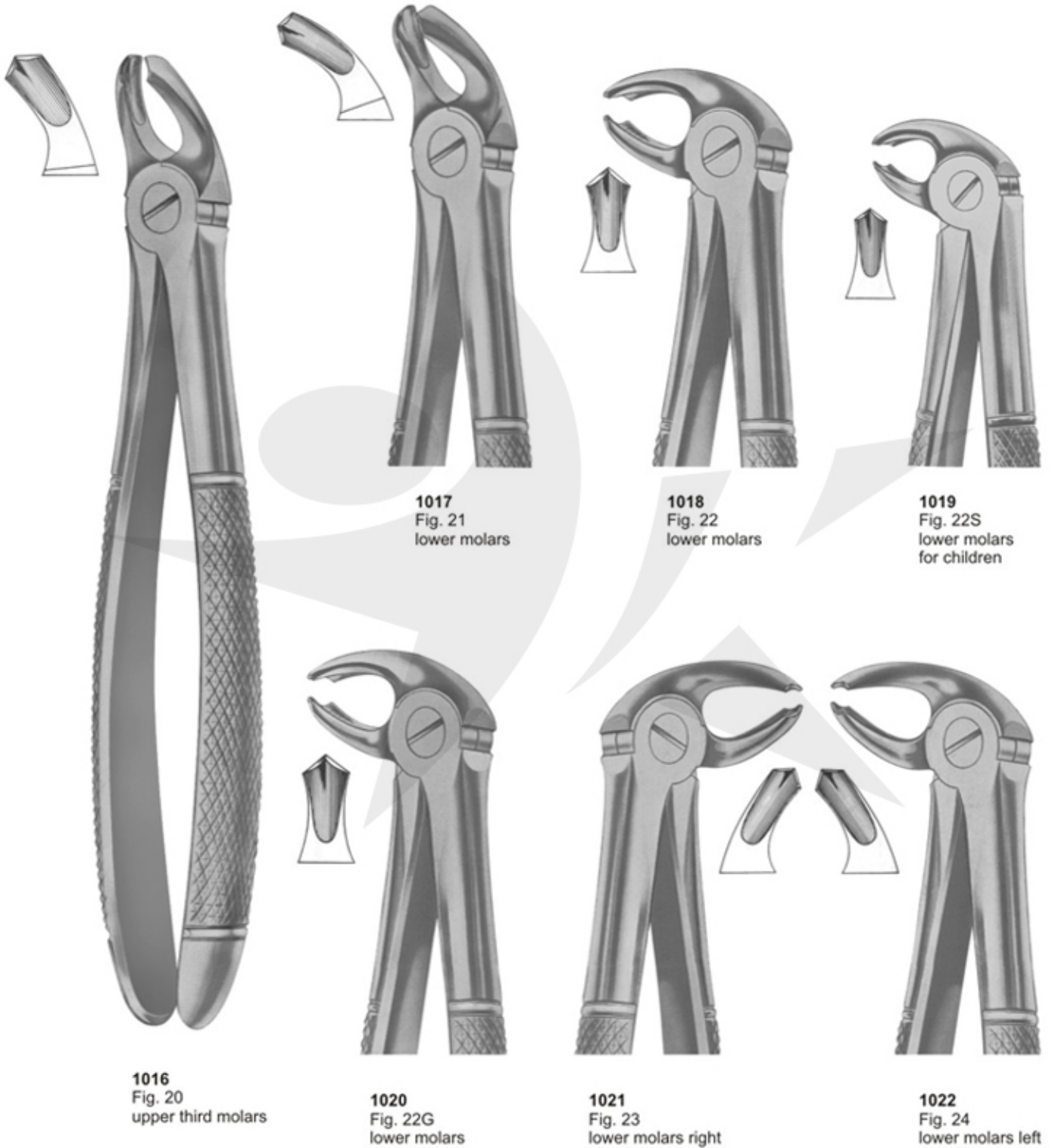



Extracting Forceps "English Pattern"



1023
Fig. 29
upper roots



1024
Fig. 29S
upper roots for children



1025
Fig. 30
upper roots

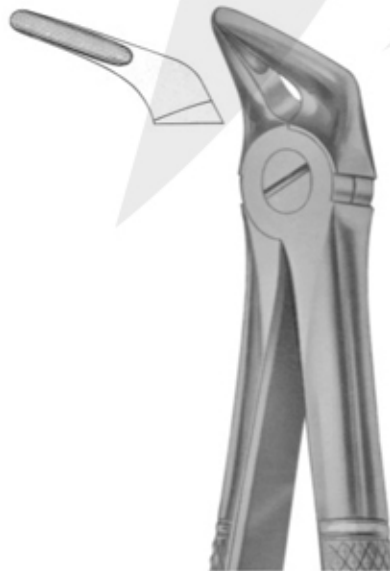

1026
Fig. 31
lower roots



1027
Fig. 32
lower molars



1028
Fig. 30S
upper roots
for children



Extracting Forceps "English Pattern"

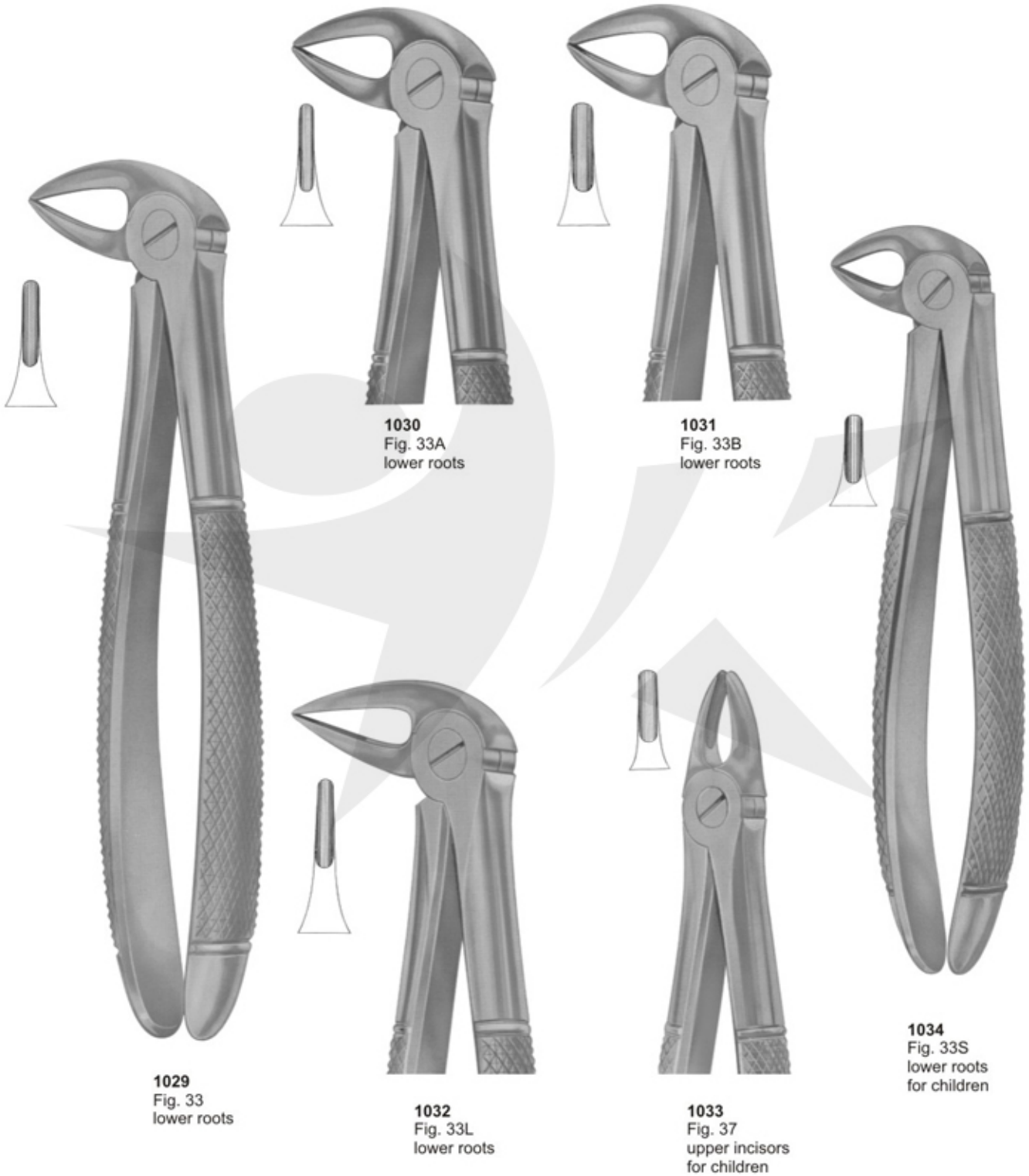



Extracting Forceps "English Pattern"



1035
Fig. 38
lower incisors &
canines for children



1036
Fig. 39
upper molars
for children



1037
Fig. 39R
upper molars right
for children



1040
Fig. 39L
upper molars left
for children



1038
Fig. 39A
upper molars
for children



1039
Fig. 40
lower molars
for children



Extracting Forceps “English Pattern”

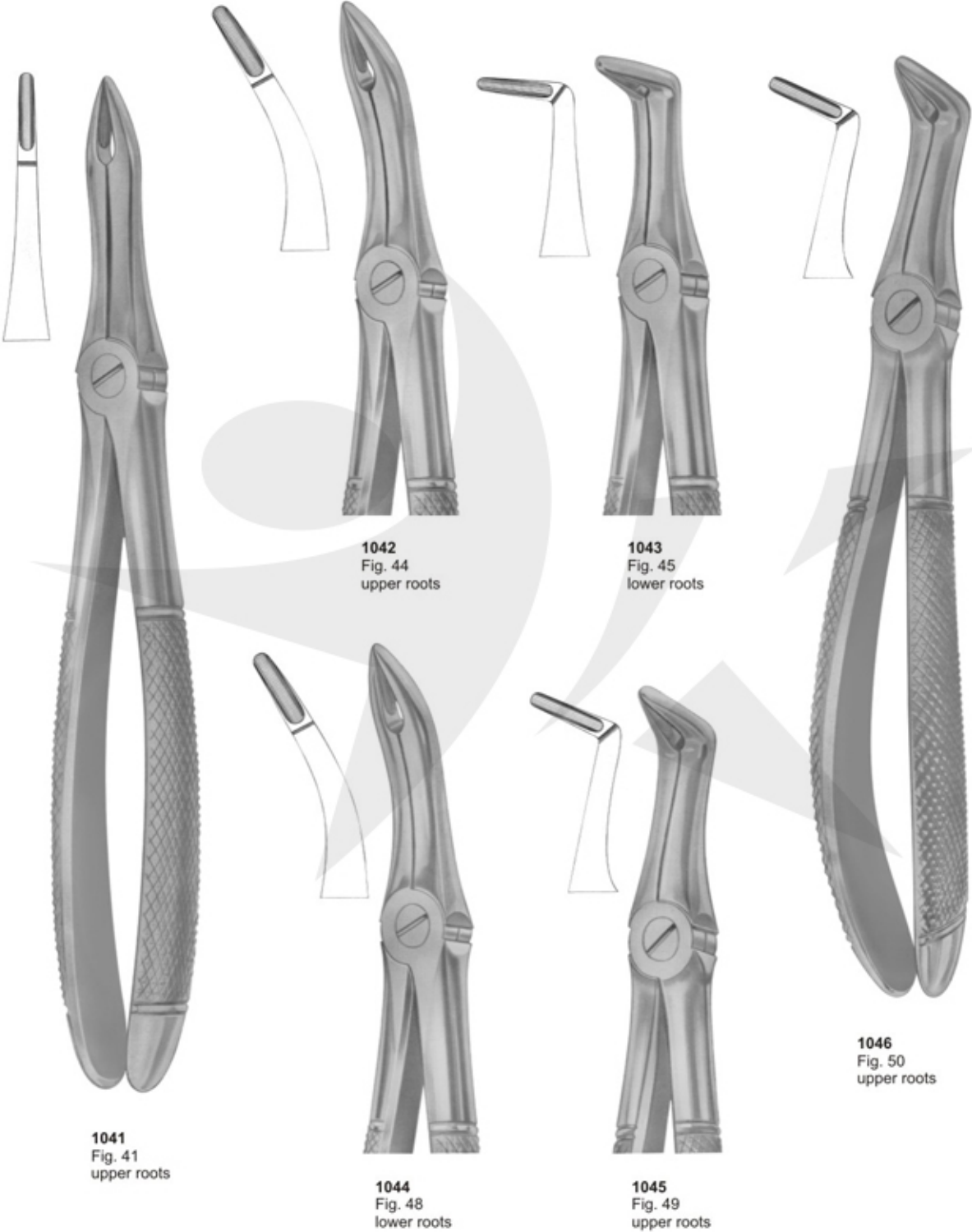

1041
Fig. 41
upper roots

1042
Fig. 44
upper roots

1043
Fig. 45
lower roots

1046
Fig. 50
upper roots

1044
Fig. 48
lower roots

1045
Fig. 49
upper roots



Extracting Forceps “English Pattern”

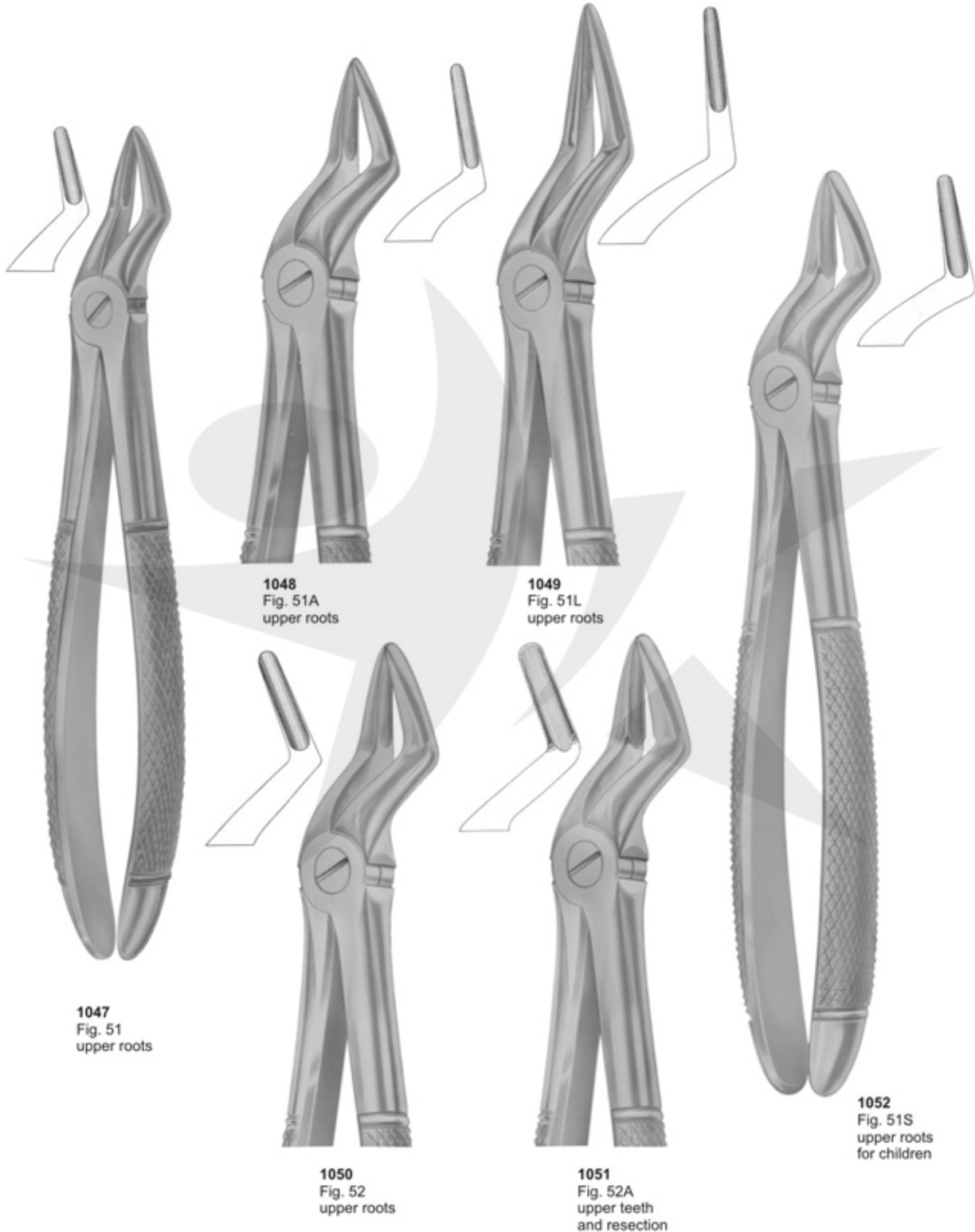



Extracting Forceps "English Pattern"



1053
Fig. 54
for separating
upper molars

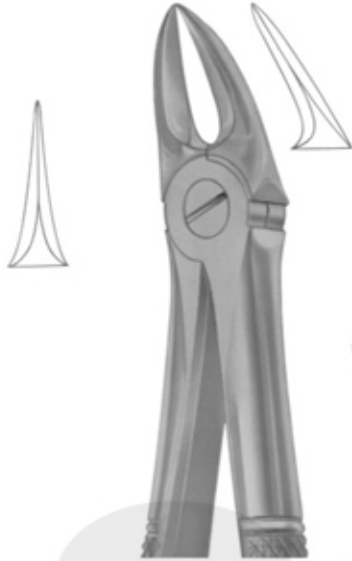

1054
Fig. 55
for separating
upper molars



1055
Fig. 56
for separating
lower molars



1056
Fig. 65R
upper molars
right



1057
Fig. 65L
upper molars left



1058
Fig. 67
upper third molars

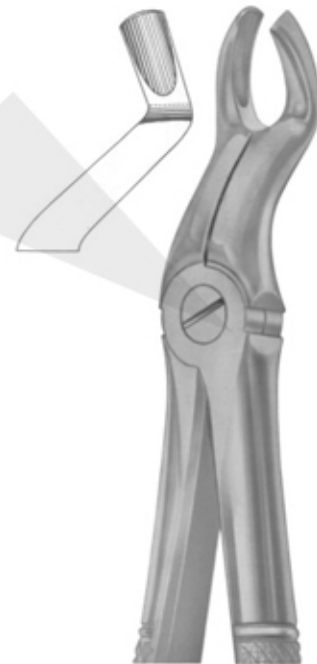

1059
Fig. 67A
upper third molars



Extracting Forceps "English Pattern"

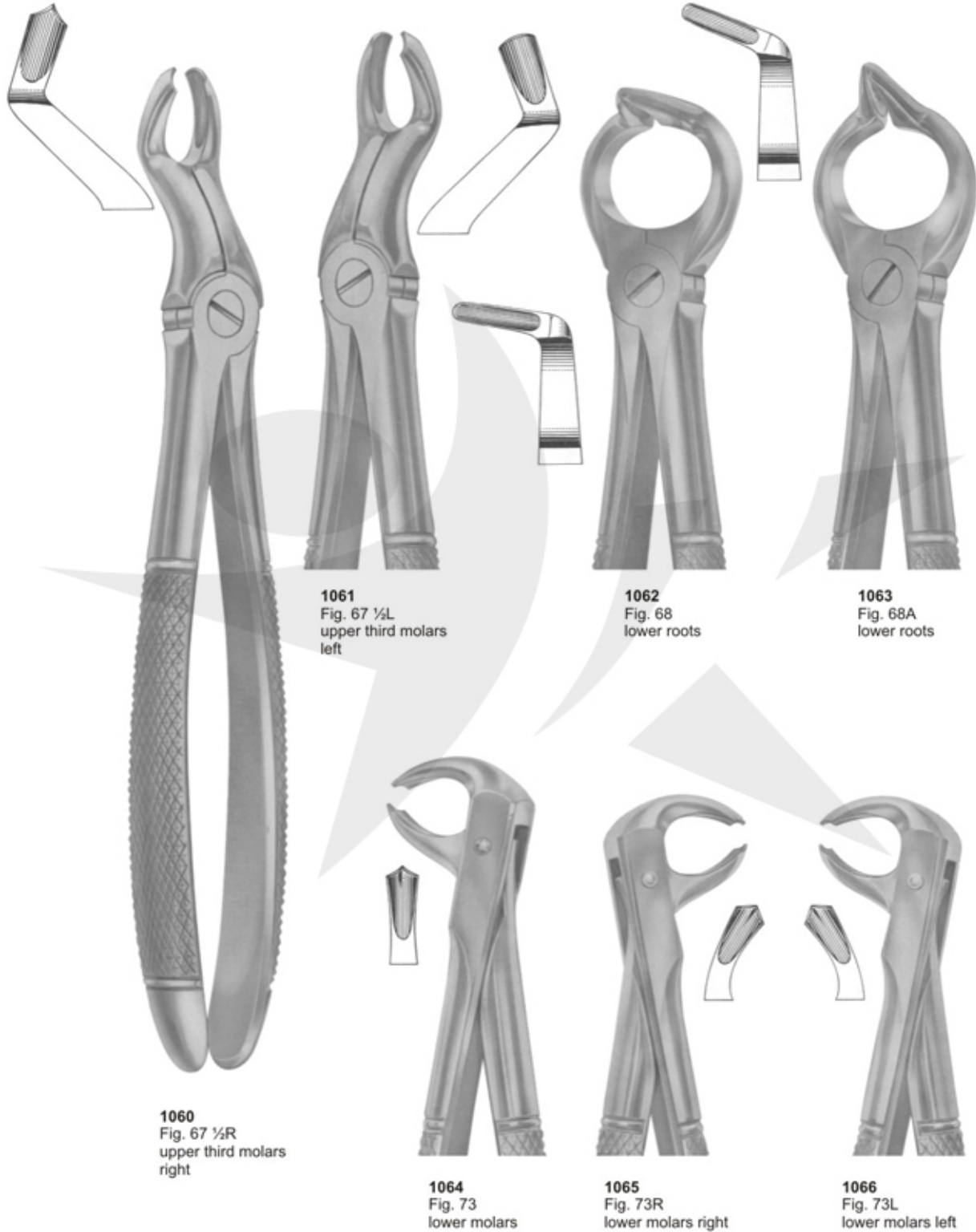



Extracting Forceps "English Pattern"



1067
Fig. 73A
lower molars



1068
Fig. 73S
lower molars



1069
Fig. 73B
lower molars for children

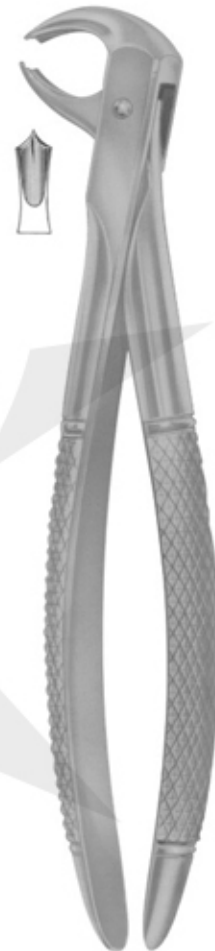

1072
Fig. 73K
lower molars
for children



1070
Fig. 74
lower roots

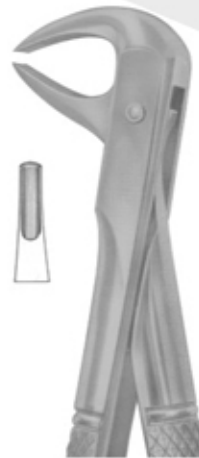

1071
Fig. 74D
lower roots



Extracting Forceps "English Pattern"

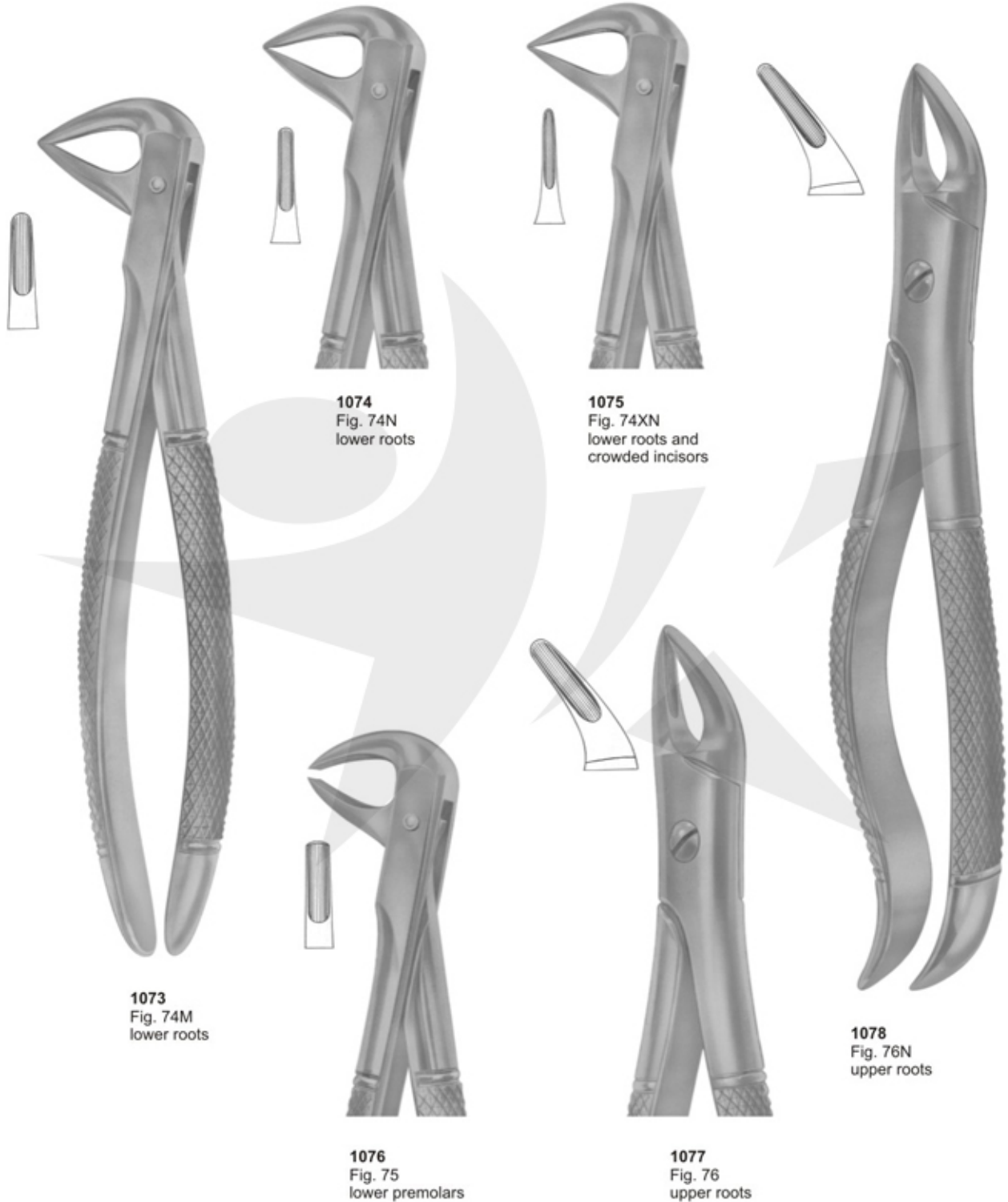



Extracting Forceps “English Pattern”



1079
Fig. 76S
upper roots



1080
Fig. 79
lower third molars



1081
Fig. 79A
lower third molars



1082
Fig. 81
lower premolars
and roots



Extracting Forceps "English Pattern"



1083
Fig. 86A
lower molars



1084
Fig. 86B
lower molars



1085
Fig. 86C
lower molars



1086
Fig. 87
lower molars



1087
Fig. 91
for separating
lower molars



1088
Fig. 99
lower molars



Extracting Forceps "English Pattern"



1089
Fig. 101
upper premolars
and roots



1090
Fig. 100
upper roots



1091
Fig. 99 1/4
lower molars

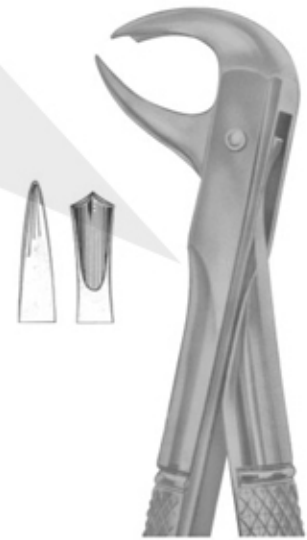

1092
Fig. 99 1/2
lower molars



Extracting Forceps “English Pattern”



1093
Fig. 102
upper molars right



1094
Fig. 103
upper molars left



1095
Fig. 105
lower incisors



1096
Fig. 106
lower incisors

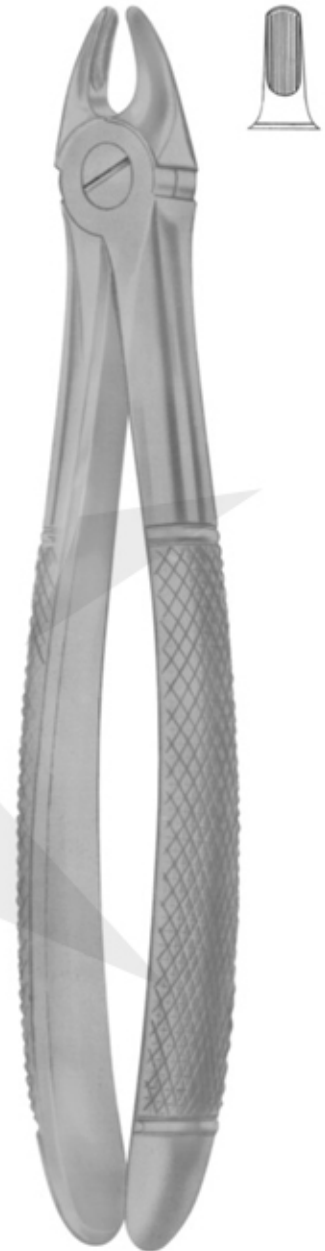

1097
Fig. 103
upper canines



Extracting Forceps "English Pattern"

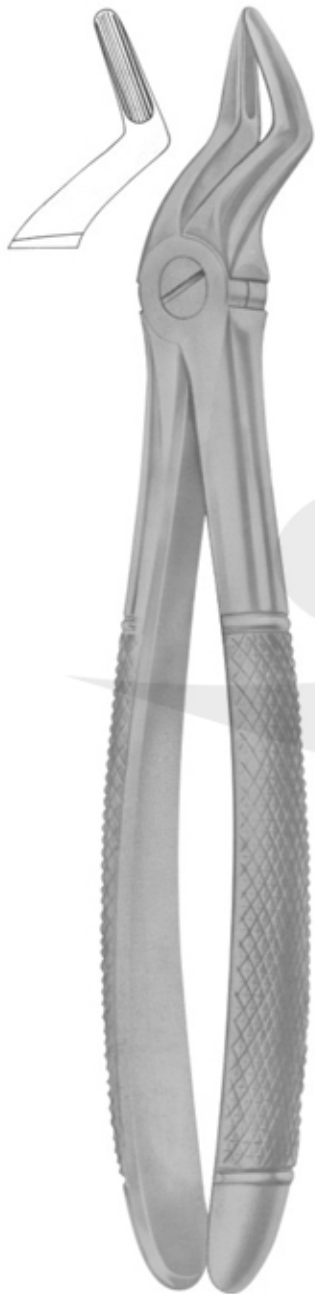

1098
Fig. 112
upper roots



1099
Fig. 113
upper roots



1101
Fig. 136
upper premolars
and roots

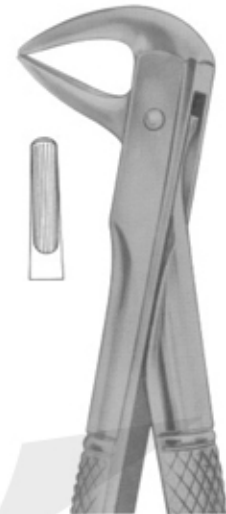

1102
Fig. 137
lower incisors
and roots



1100
Fig. 114
upper roots



1103
Fig. 143
lower roots



Extracting Forceps "English Pattern"

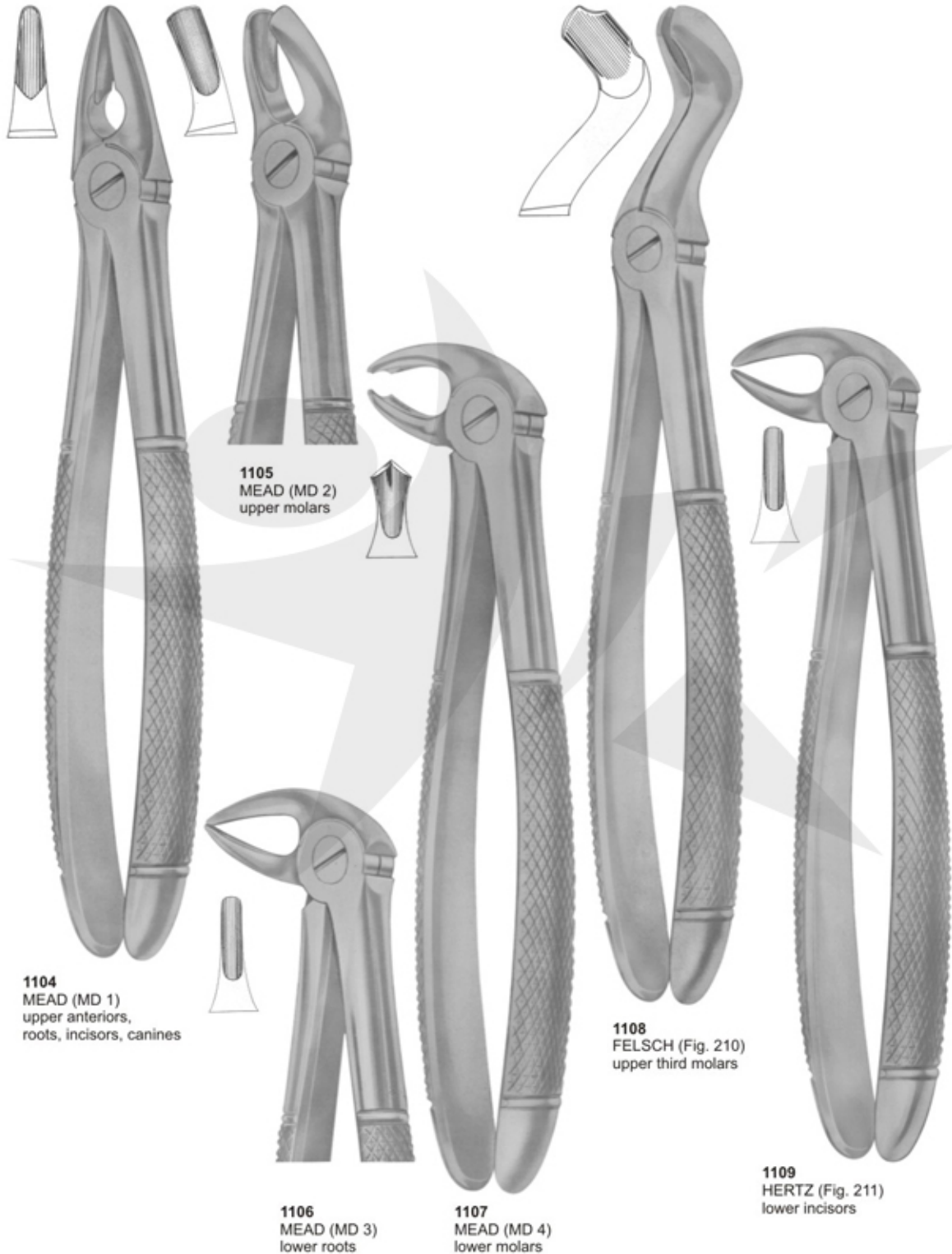



Extracting Forceps "English Pattern"



1111
ROUTURIER (Fig. 213)
(22 ½ R)
lower molars
and wisdom right

1110
ROUTURIER (Fig. 212)
(22 ½ L)
lower molars
and wisdom left



1112
ROUTURIER (Fig. 214)
(22 ½ L)
lower molars
and wisdom left

1113
ROUTURIER (Fig. 215)
(33 ½ R)
lower molars
and wisdom right

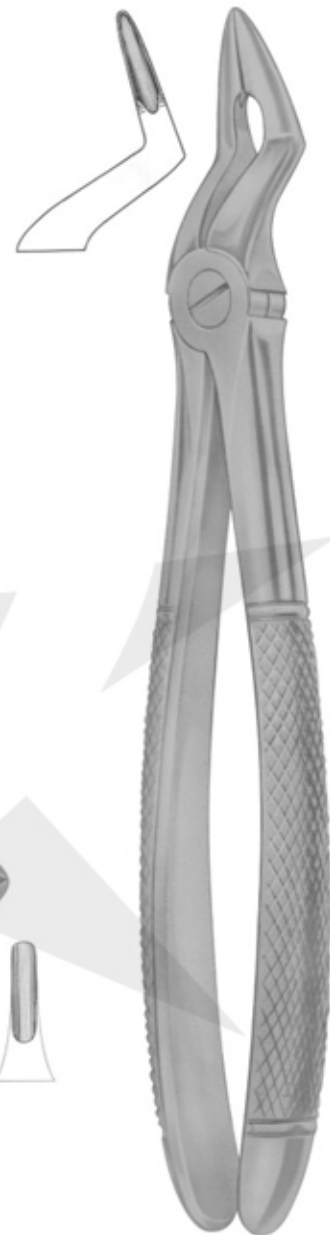

1114
RESECTION FORCEPS
(216/Witzel)
upper roots



Extracting Forceps "English Pattern"



1115
Fig. 5



1116
Fig. 6



1117
Fig. 9



1118
Fig. 10



1119
Fig. 11



1120
Fig. 12



1121
Fig. 14



1122
Fig. 15



Extracting Forceps "English Pattern"



1123
Fig. 25



1124
Fig. 26



1125
Fig. 27



1126
Fig. 28



1127
Fig. 34



1128
Fig. 35



1129
Fig. 42



1130
Fig. 43



Extracting Forceps "English Pattern"

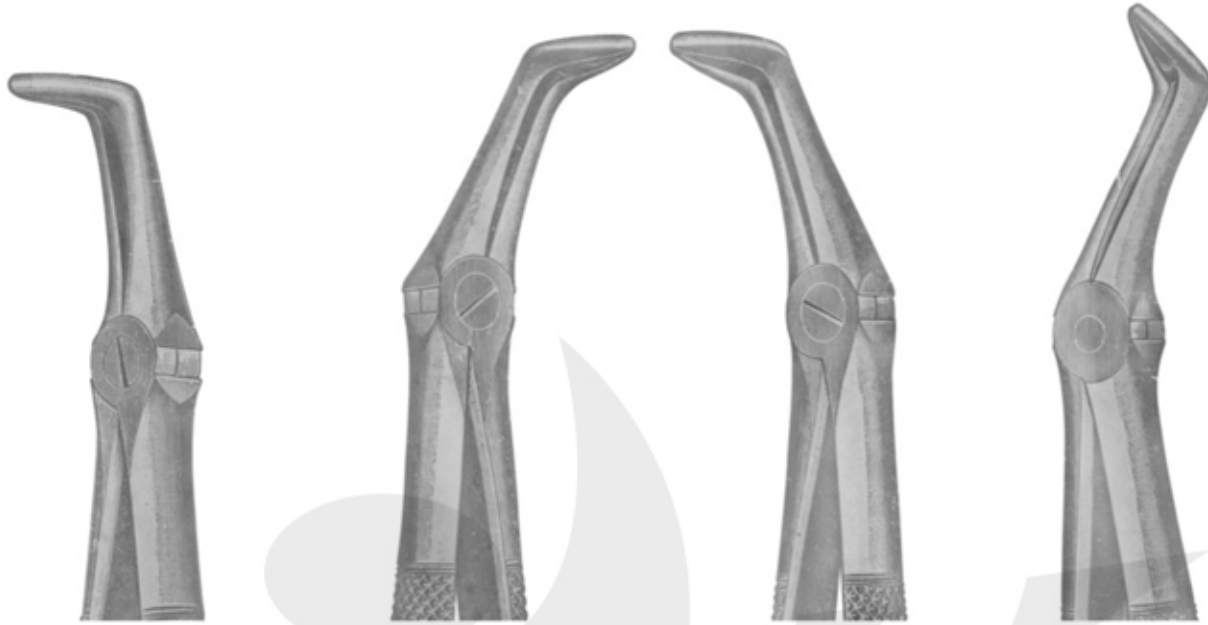

1131
Fig. 44A

1132
Fig. 46

1133
Fig. 47

1134
Fig. 50A



1135
Fig. 74R

1136
Fig. 74L

1137
Fig. 75R

1138
Fig. 75L



Extracting Forceps "English Pattern"



1139
Fig. 94



1140
Fig. 95



1141
Fig. 98



1142
Fig. 105



1143
Fig. 106



1144
Fig. 2002



Extracting Forceps "English Pattern"



1145
Fig. 1
upper laterals
and canines



1146
Fig. 2
upper laterals
and canines

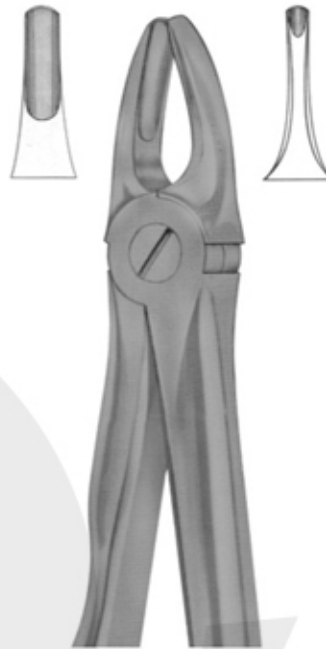

1147
Fig. 3
upper incisors
and canines

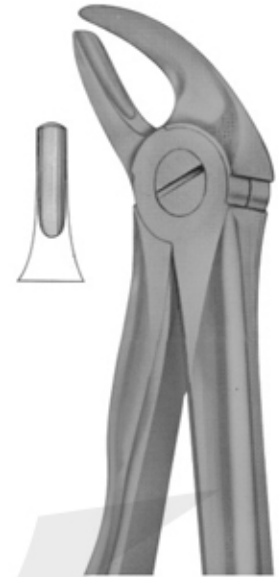

1148
Fig. 4
lower incisors
and canines



1149
Fig. 7
upper premolars

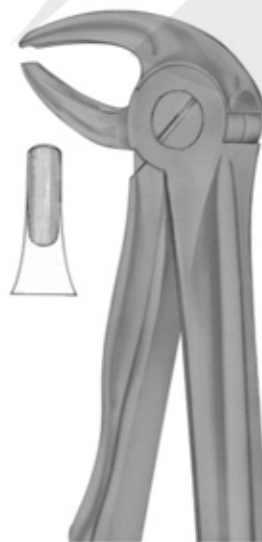

1150
Fig. 13
lower premolars



1151
Fig. 13S
lower premolars
for children



Extracting Forceps "English Pattern"



1152
Fig. 17
upper molars right



1153
Fig. 18
upper molars left



1154
Fig. 18A
upper molars



1155
Fig. 18B
upper molars



1156
Fig. 19
upper third molars



1157
Fig. 22
lower molars



1158
Fig. 22S
lower molars
for children



Extracting Forceps "English Pattern"



1159
Fig. 29
upper roots



1160
Fig. 29S
upper roots
for children



1161
Fig. 30
upper roots



1162
Fig. 30S
upper roots
for children



1163
Fig. 33
lower roots



1164
Fig. 33A
lower roots



1165
Fig. 33B
lower roots



Extracting Forceps "English Pattern"



1166
Fig. 33L
lower roots



1167
Fig. 33S
lower roots
for children



1168
Fig. 37
upper incisors
for children



1169
Fig. 39
upper incisors
for children



1170
Fig. 39A
upper molars
for children



1171
Fig. 39R
upper molars right
for children



1172
Fig. 39L
upper molars left
for children



Extracting Forceps "English Pattern"

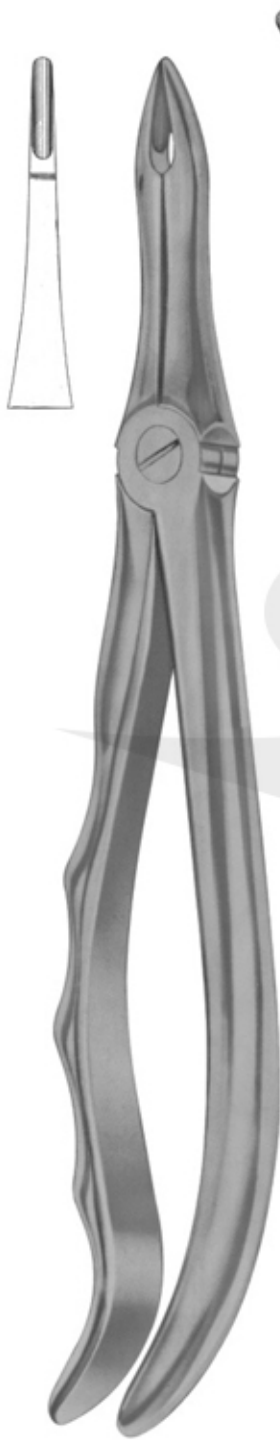

1173
Fig. 41
upper roots

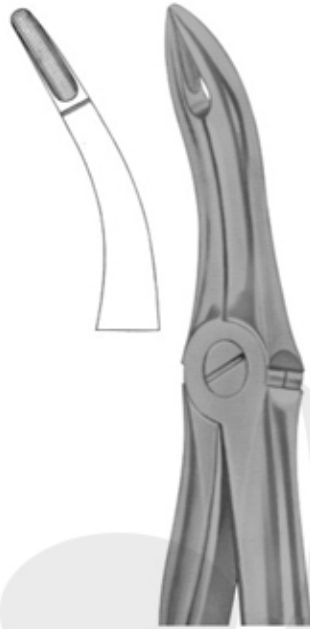

1174
Fig. 44
upper roots

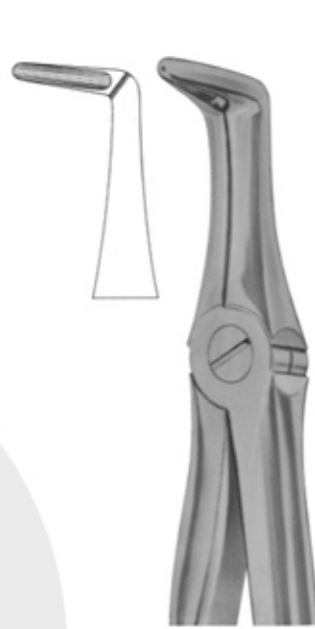

1175
Fig. 45
lower roots

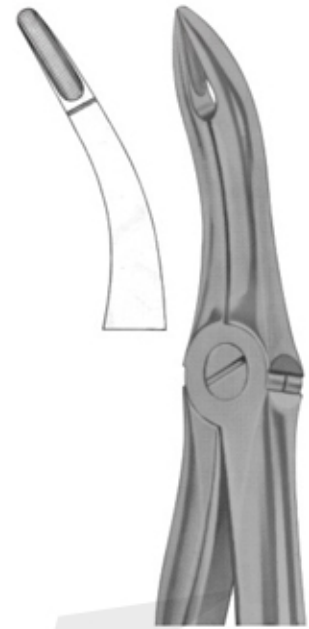

1176
Fig. 48
lower roots

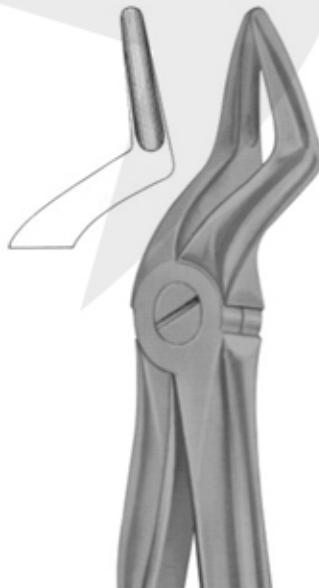

1177
Fig. 51
upper roots

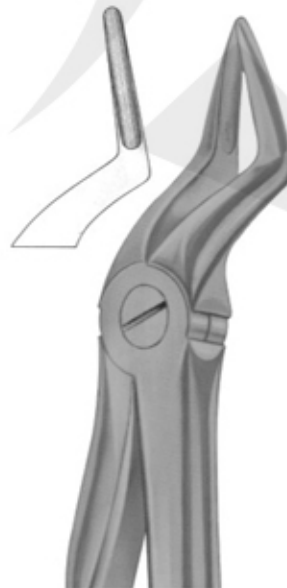

1178
Fig. 51A
upper roots



1179
Fig. 51S
upper roots
for children



Extracting Forceps "English Pattern"

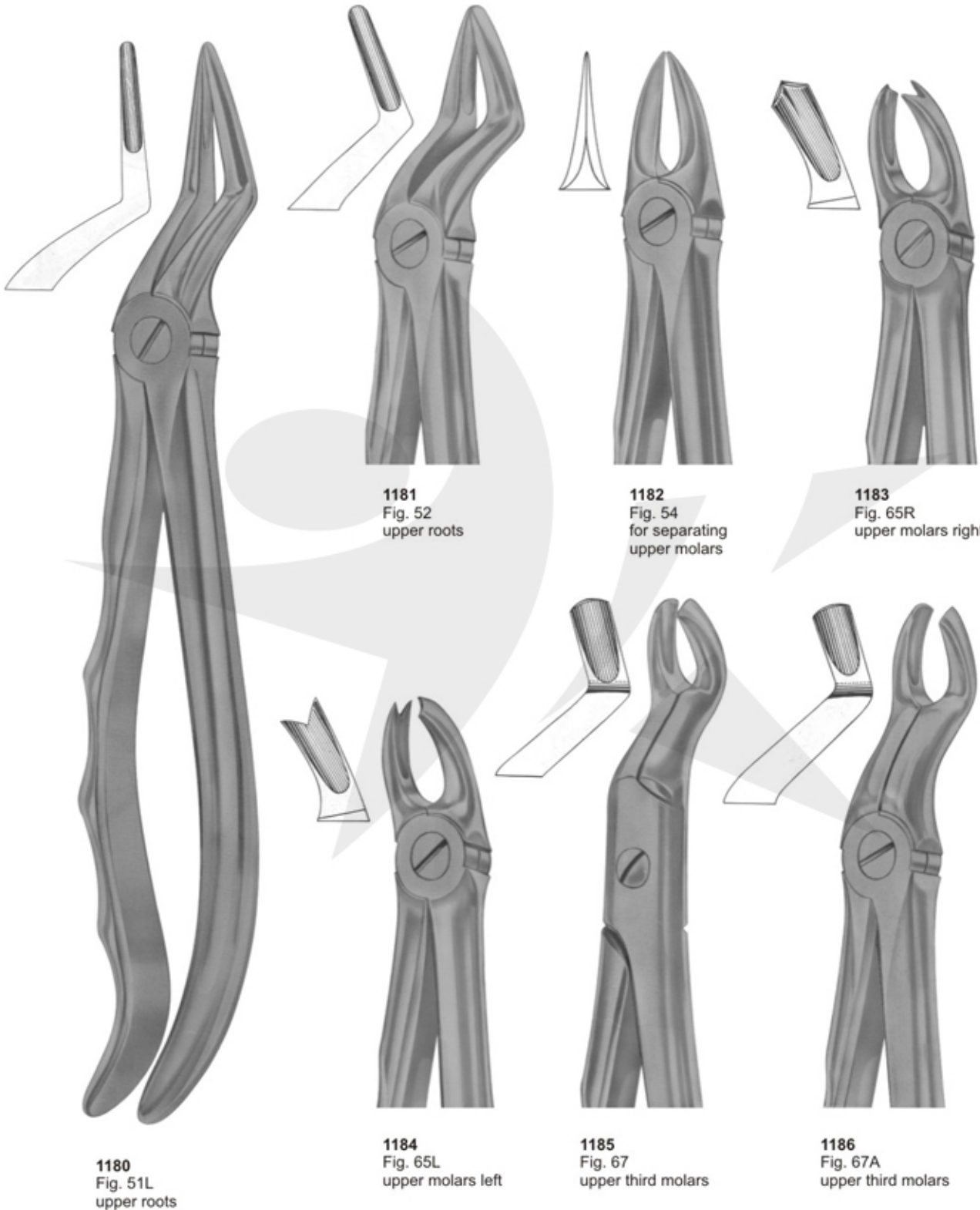



Extracting Forceps "English Pattern"



1187
Fig. 67 1/2 R
upper third molars
right

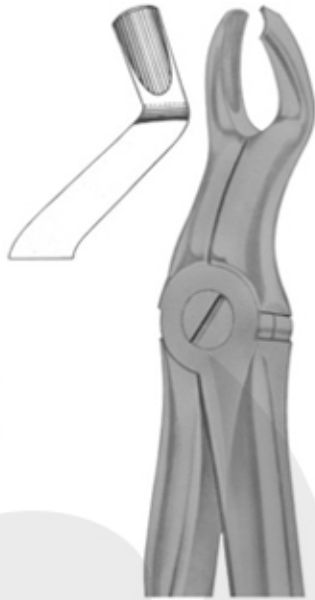

1188
Fig. 67 1/2 L
upper third molars
left



1189
Fig. 73
lower molars

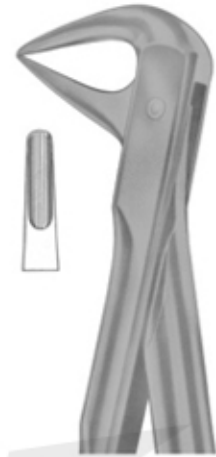

1190
Fig. 74
lower roots

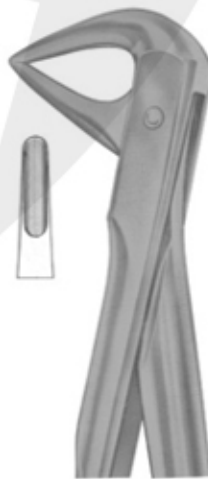

1191
Fig. 74M
lower roots



1192
Fig. 74N
lower roots



1193
Fig. 74XN
lower roots and
crowded incisors



Extracting Forceps "With Fitting Handle"



1194
Fig. 75
lower premolars



1195
Fig. 76
upper roots



1196
Fig. 76N
upper roots



1197
Fig. 81
lower premolars
and roots



1198
Fig. 76A
lower third molars



1199
Fig. 79
lower third molars



Extracting Forceps "With Fitting Handle"

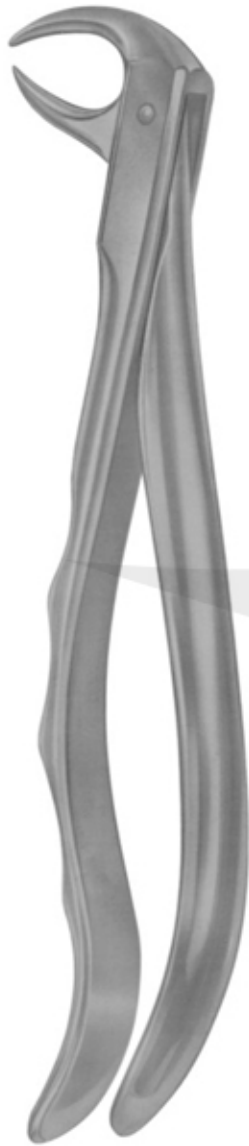

1200
Fig. 86A
lower molars



1201
Fig. 86B
lower molars



1202
Fig. 86C
lower molars



1203
Fig. 99
lower molars



1204
Fig. 99 1/4
lower molars



1205
Fig. 136
upper premolars
and roots



1206
Fig. 143
lower roots



Extracting Forceps "For Children"

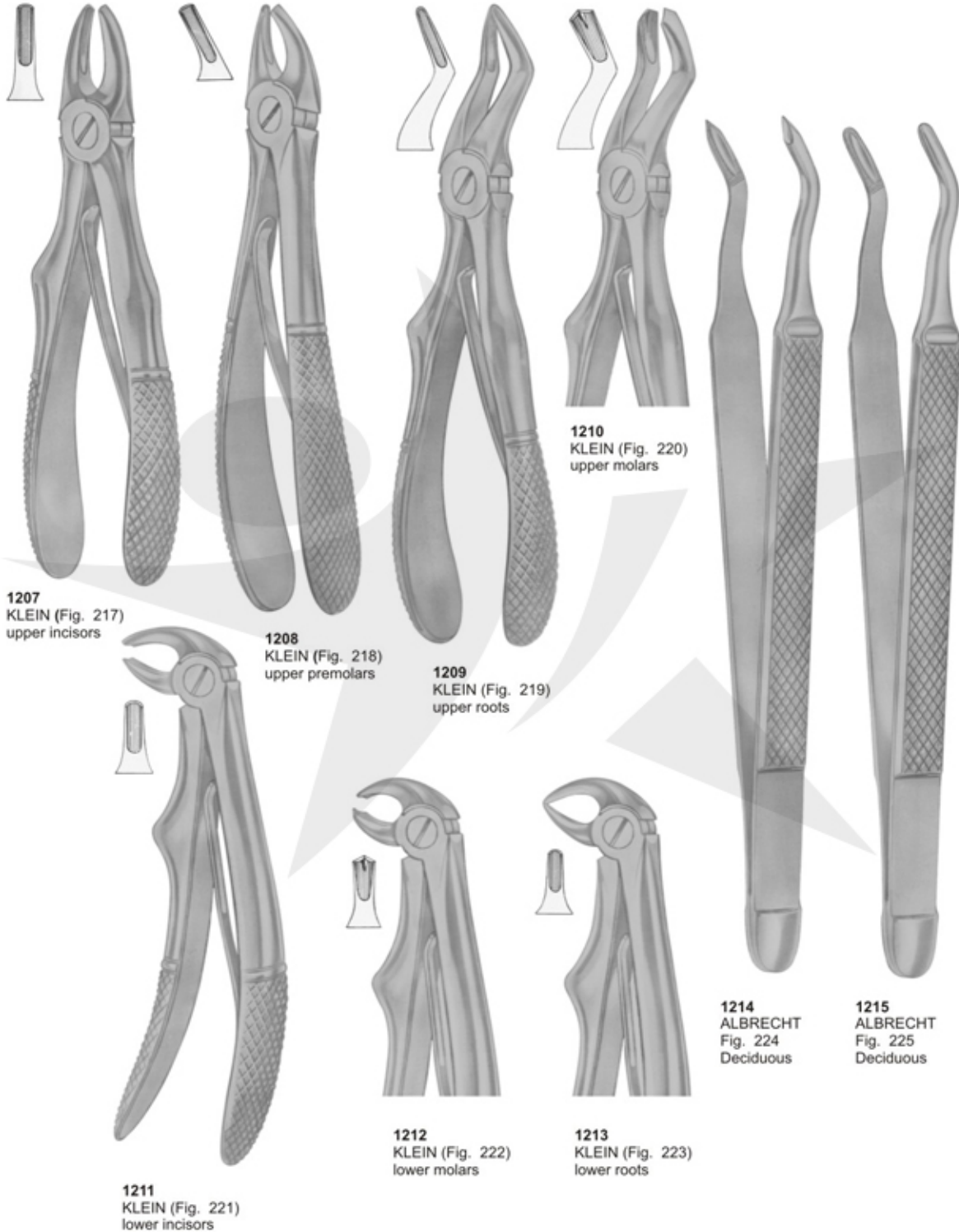



Root Splinter Forceps

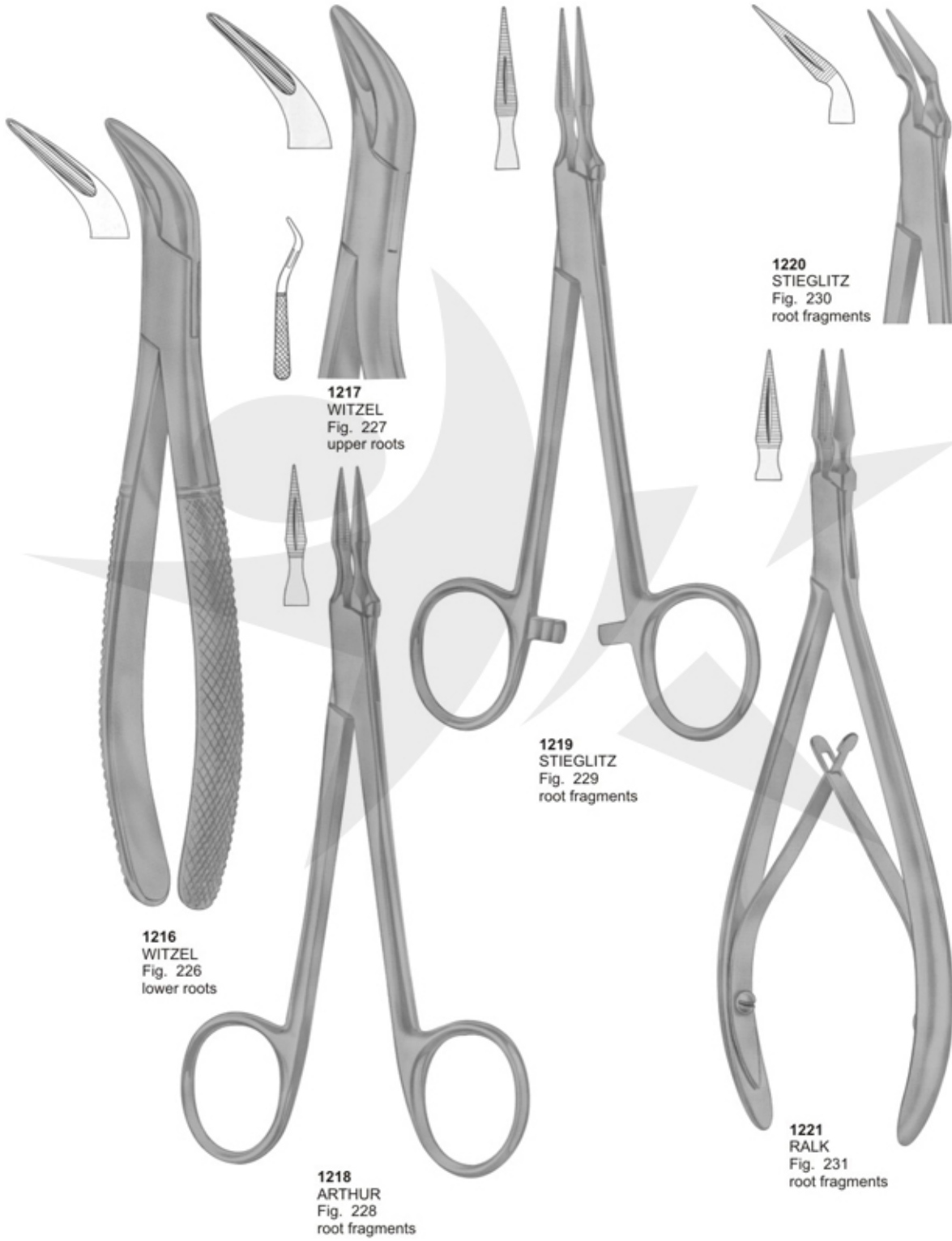

1216
WITZEL
Fig. 226
lower roots

1217
WITZEL
Fig. 227
upper roots

1219
STIEGLITZ
Fig. 229
root fragments

1218
ARTHUR
Fig. 228
root fragments

1220
STIEGLITZ
Fig. 230
root fragments

1221
RALK
Fig. 231
root fragments



Extracting Forceps "American Pattern"

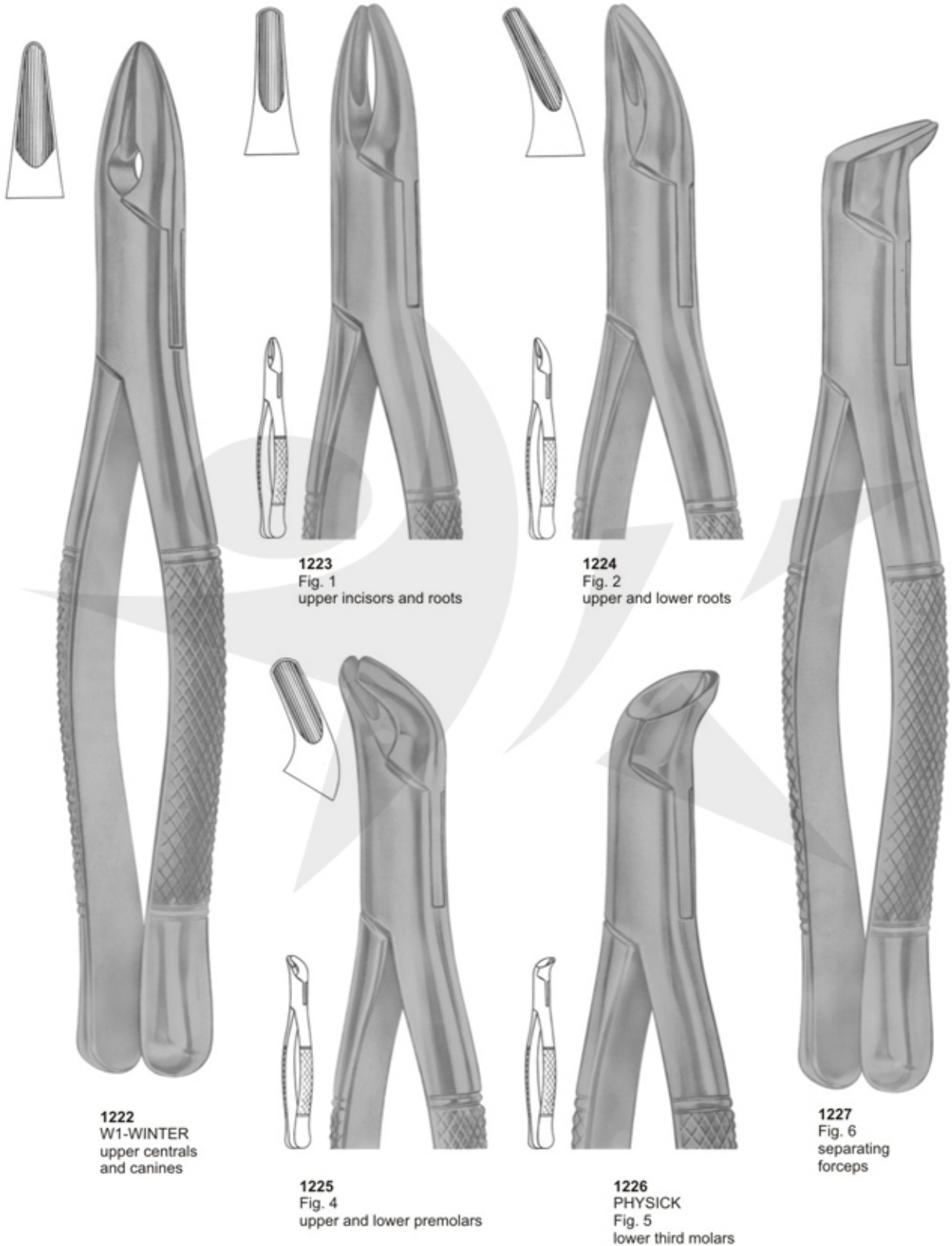



Extracting Forceps "American Pattern"

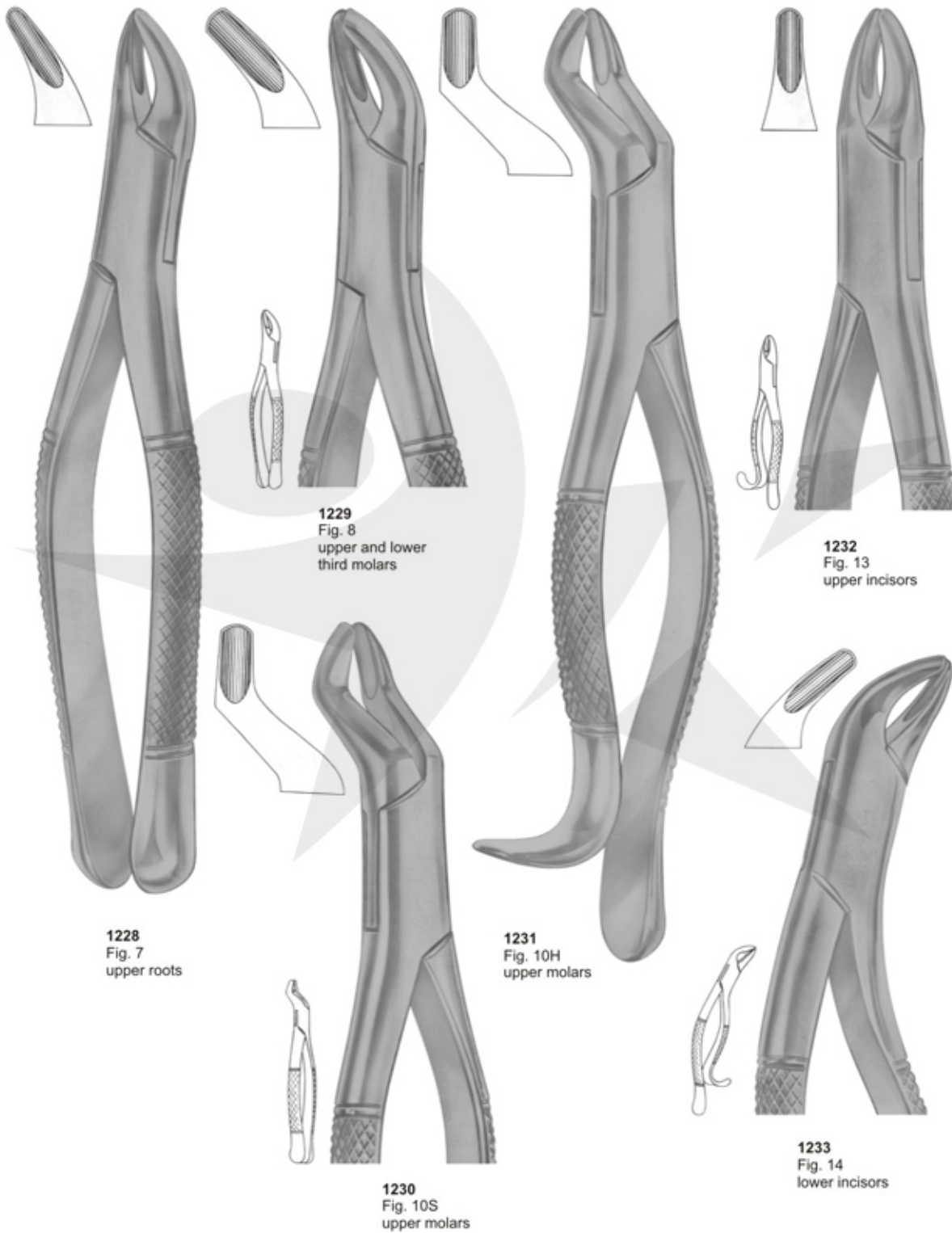



Extracting Forceps "American Pattern"

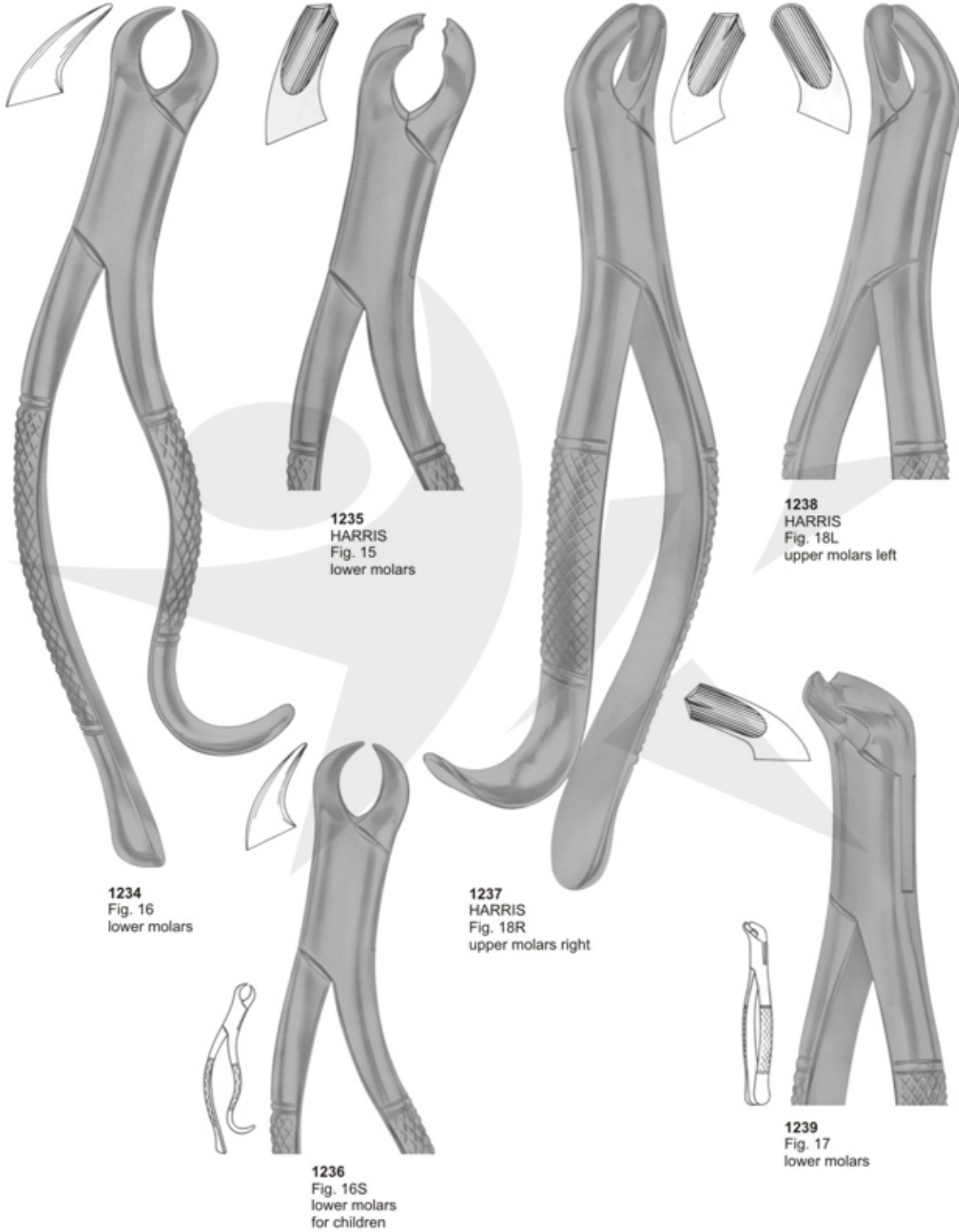



Extracting Forceps "American Pattern"

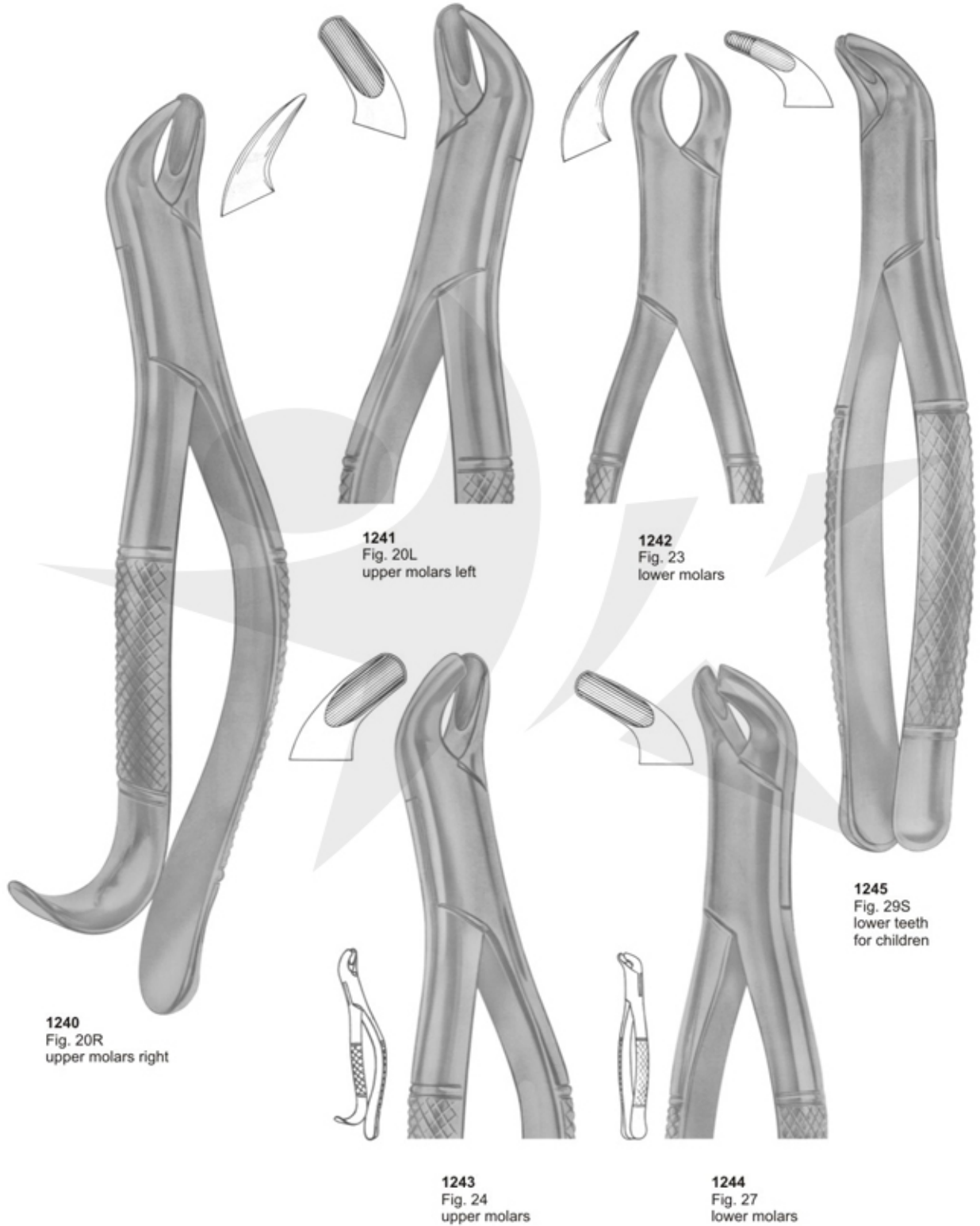



Extracting Forceps "American Pattern"

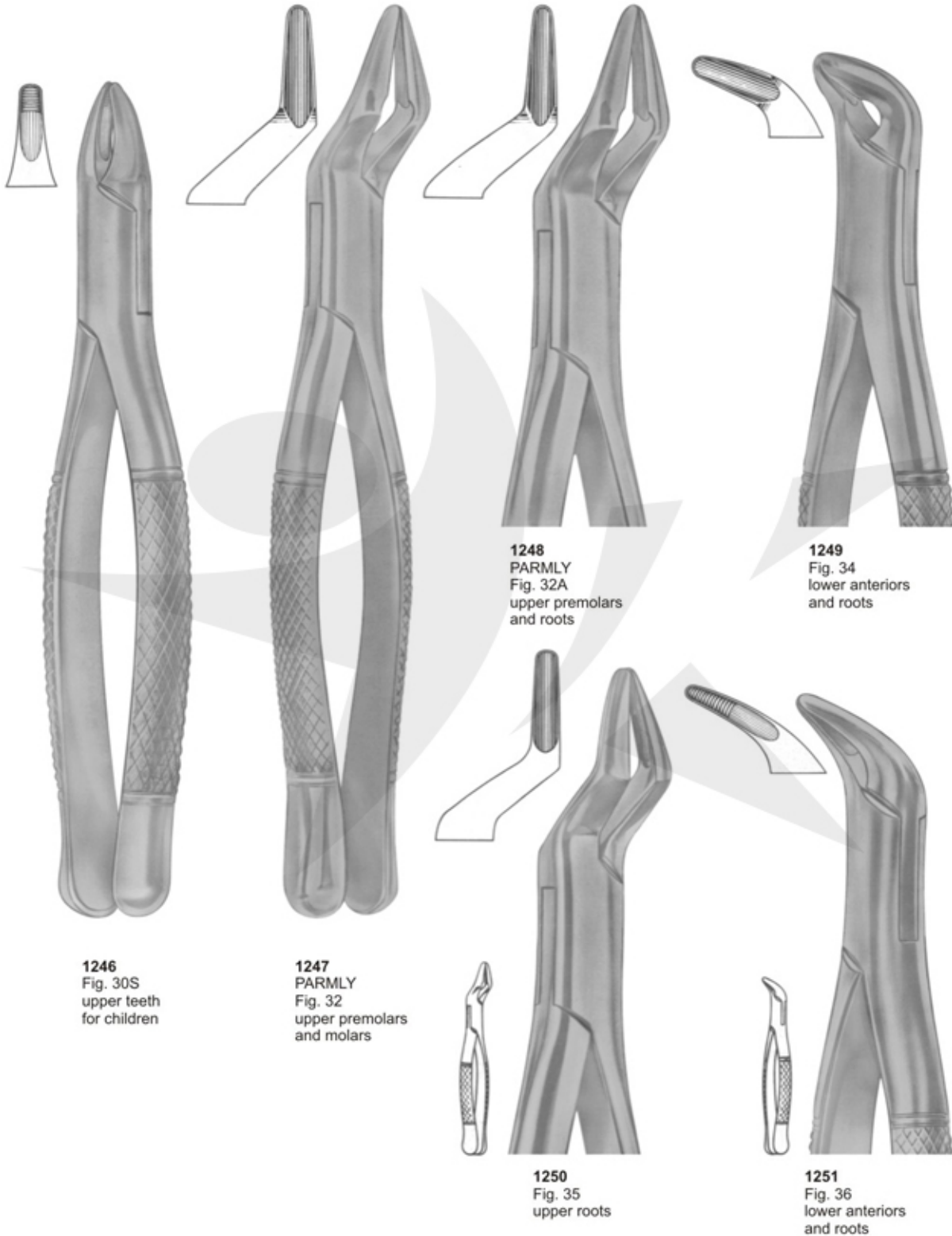



Extracting Forceps "American Pattern"



1252
Fig. 37
lower anteriors
and roots

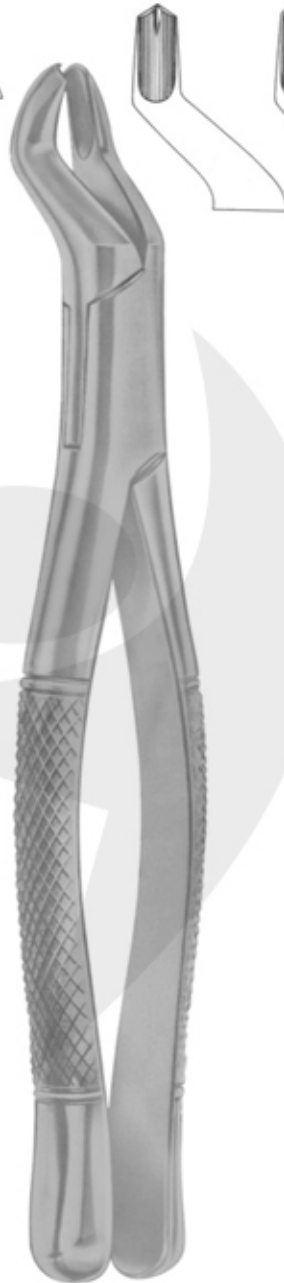

1254
Fig. 53R
upper molars right



1255
Fig. 53L
upper molars left

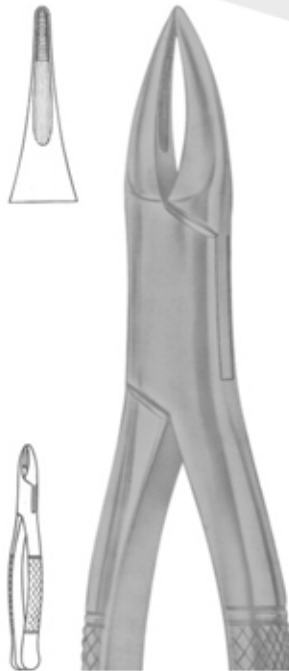

1253
Fig. 38
upper anteriors
and roots



1256
Fig. 62
incisors, premolars,
deciduous teeth



1257
Fig. 65
upper incisors
and roots



Extracting Forceps "American Pattern"

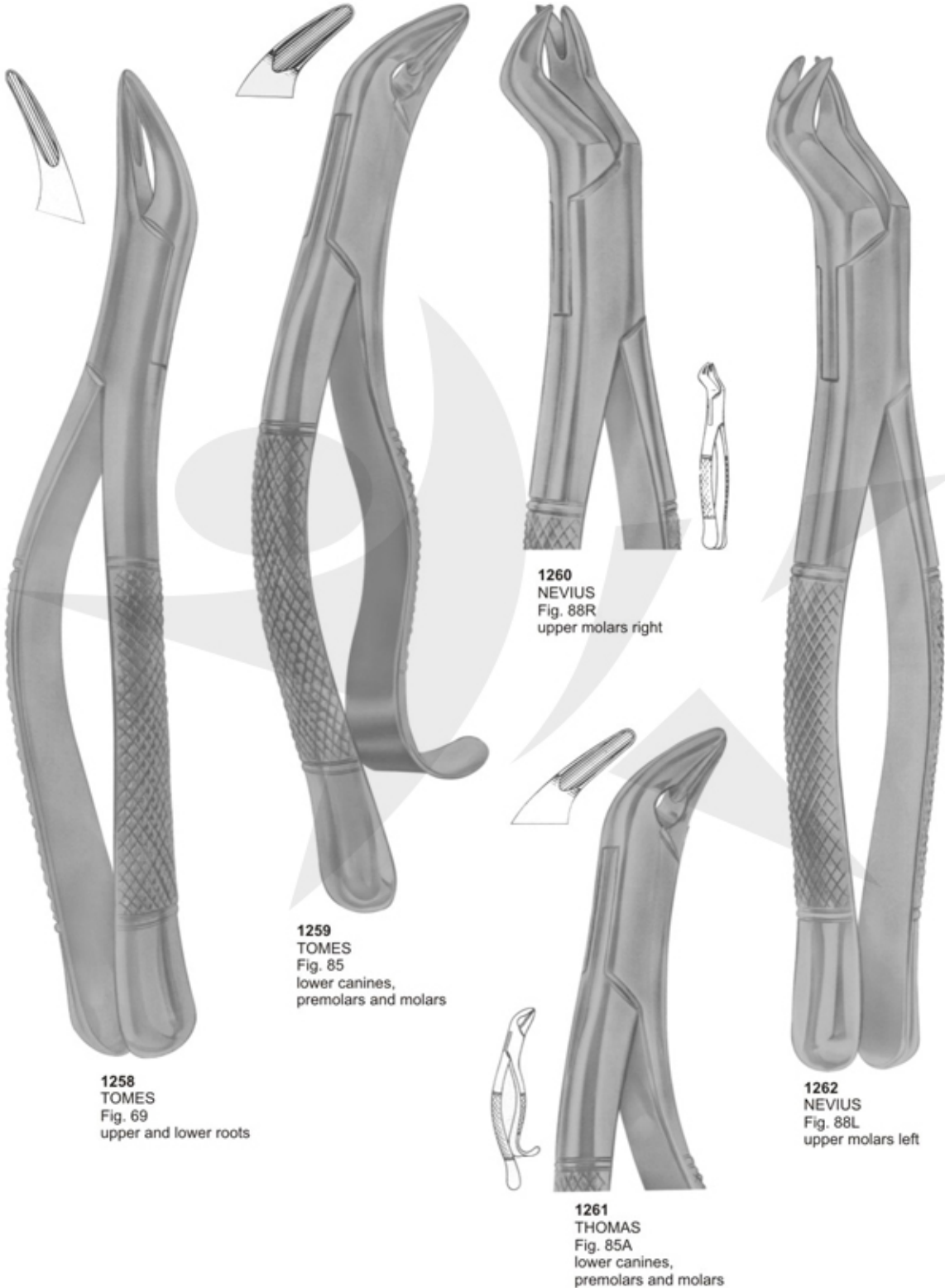



Extracting Forceps "American Pattern"

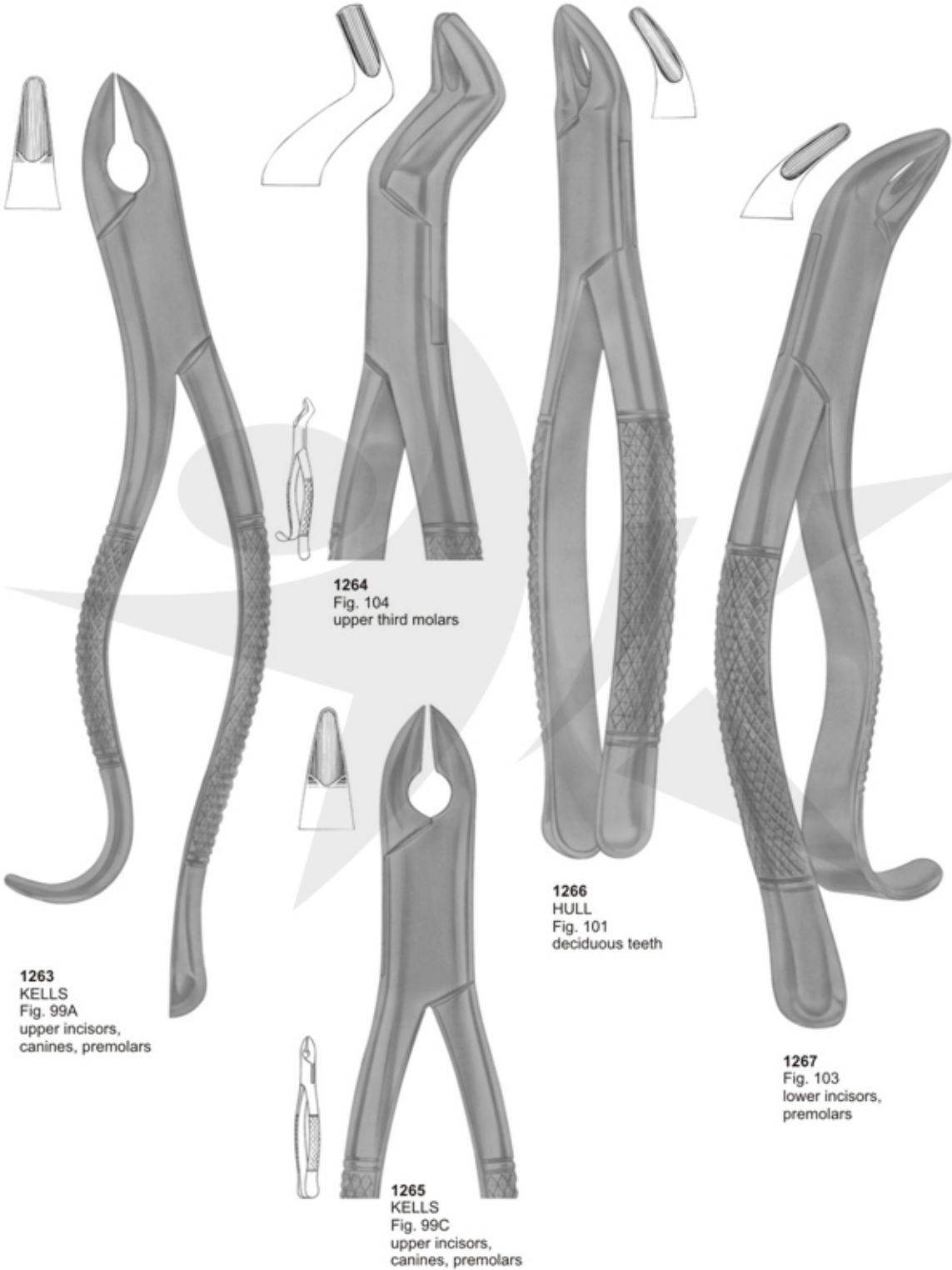

1263
KELLS
Fig. 99A
upper incisors,
canines, premolars

1264
Fig. 104
upper third molars

1266
HULL
Fig. 101
deciduous teeth

1267
Fig. 103
lower incisors,
premolars

1265
KELLS
Fig. 99C
upper incisors,
canines, premolars



Extracting Forceps "American Pattern"

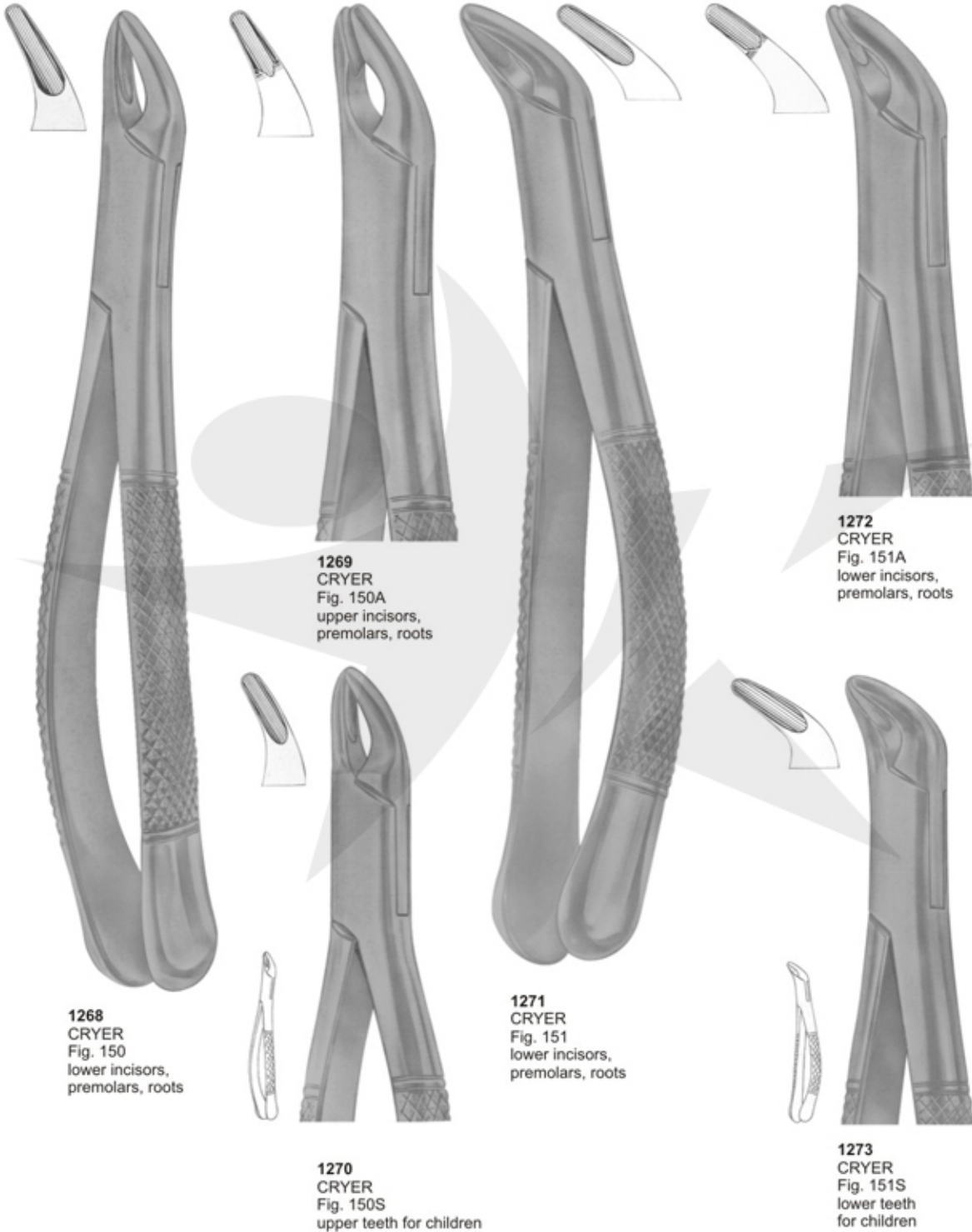



Extracting Forceps "American Pattern"

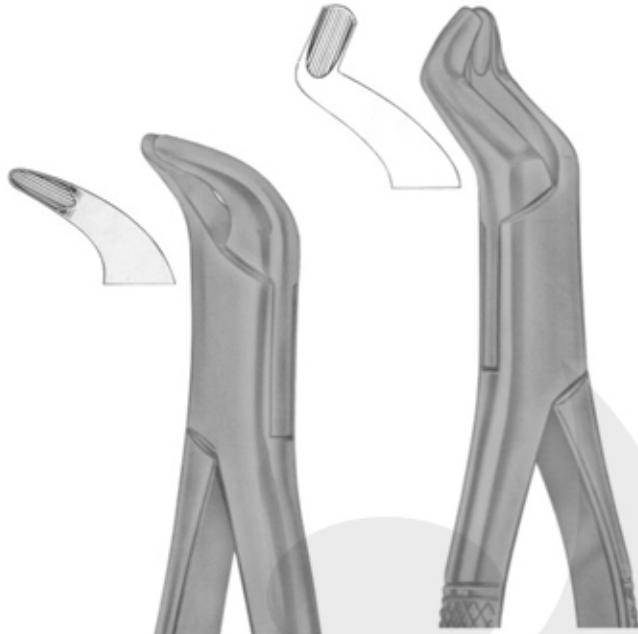

1275
Fig. 210S
upper third molars

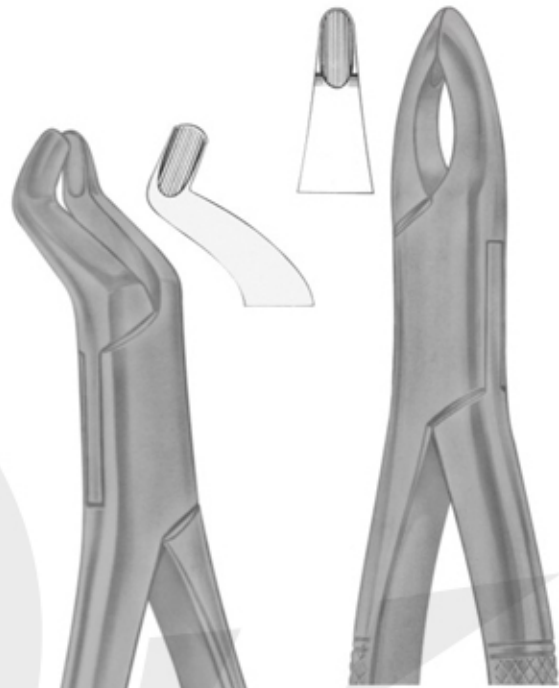

1278
Fig. 213
upper centrals and canines



1274
Fig. 203
lower incisors
and roots



1276
Fig. 201
upper incisors,
canines, premolars



1277
Fig. 210H
upper third molars

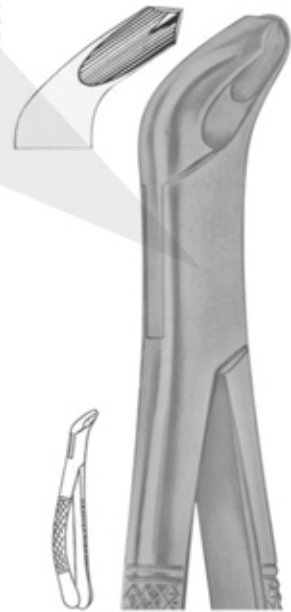

1279
Fig. 217
lower molars



Extracting Forceps "American Pattern"

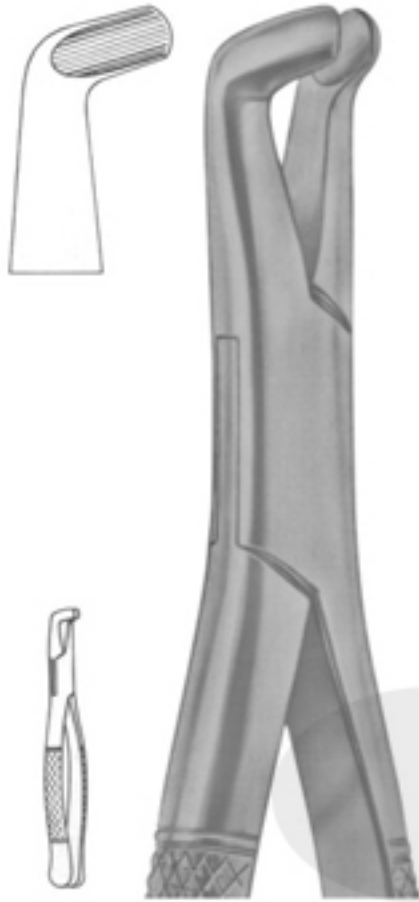

1280
Fig. 222
lower third molars



1282
Fig. 286
Swing lower molars



1283
Fig. 288
lower canines
and premolars

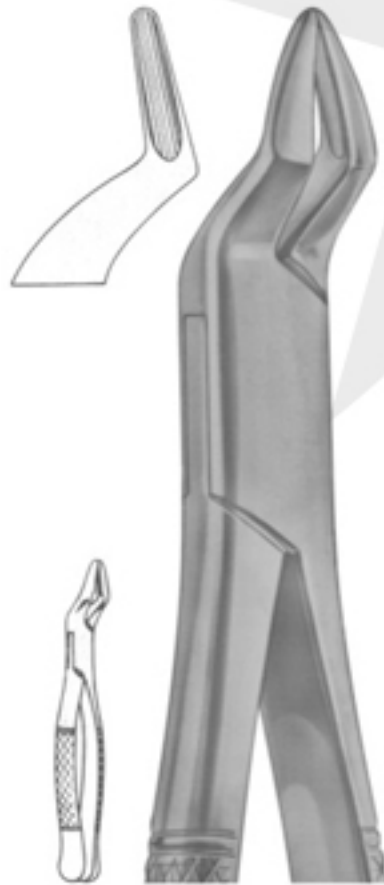

1281
Fig. 286
upper incisors and roots



Extracting Forceps "American Pattern"

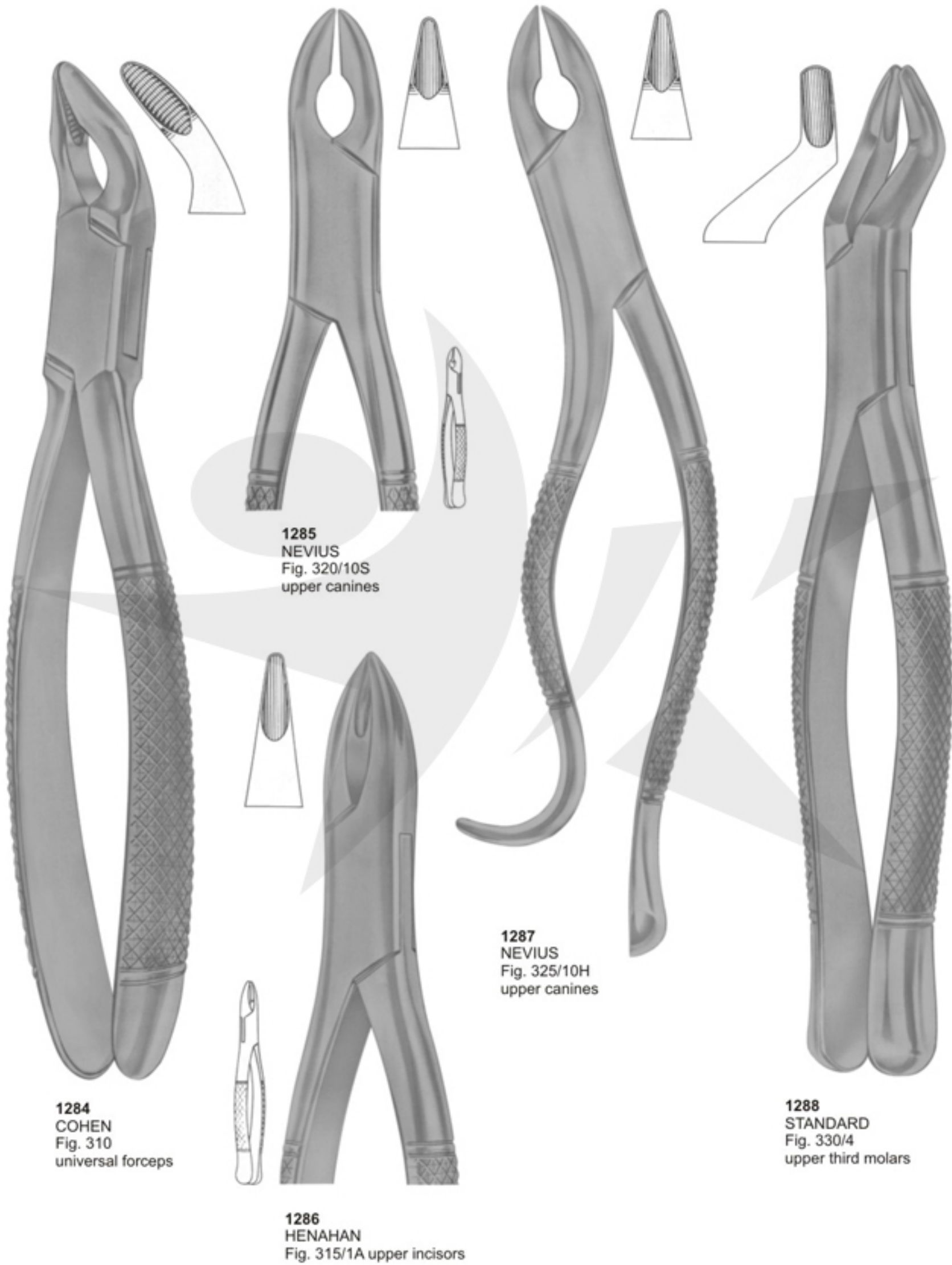



Extracting Forceps "American Pattern"

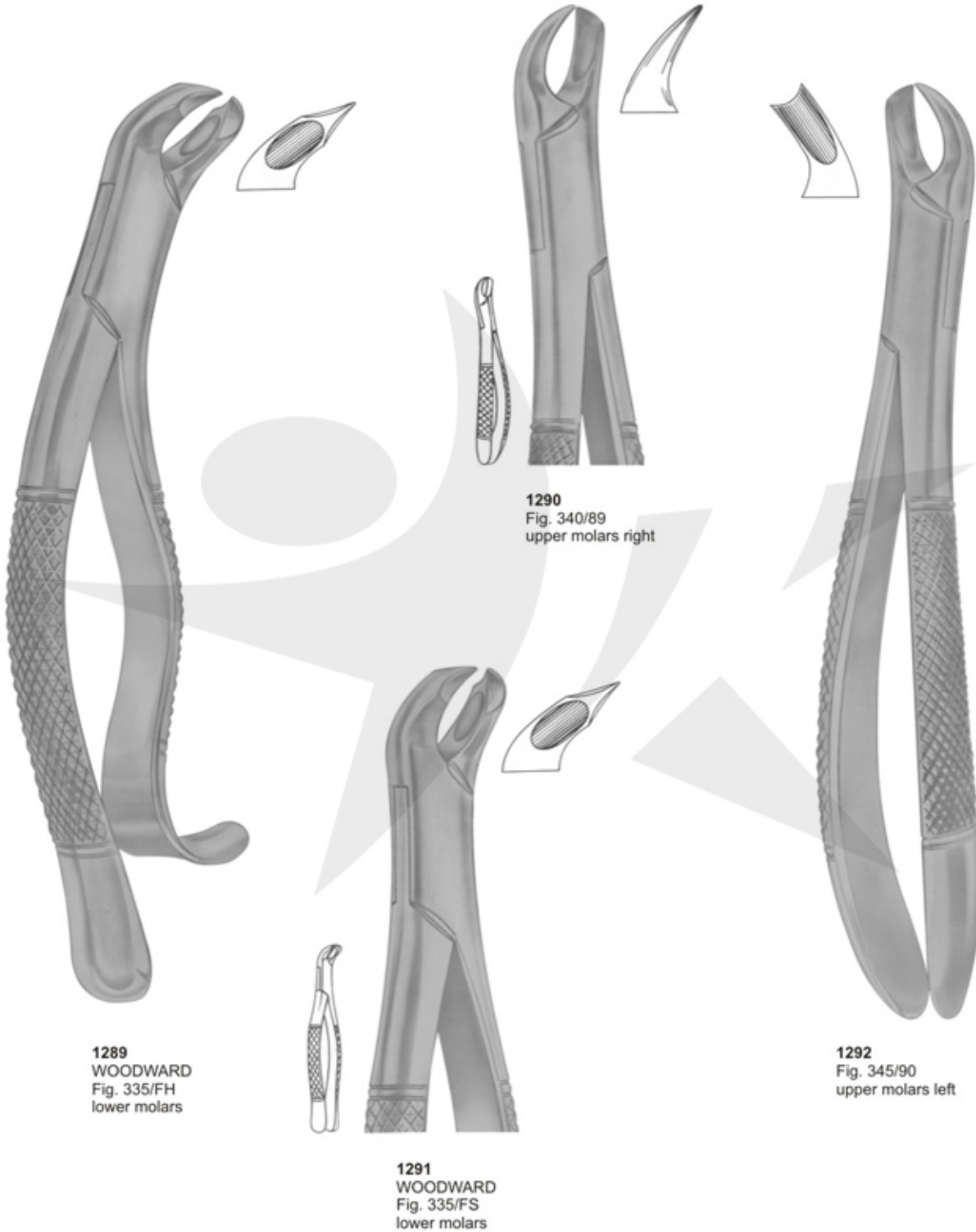



Forceps For Children "American Pattern"

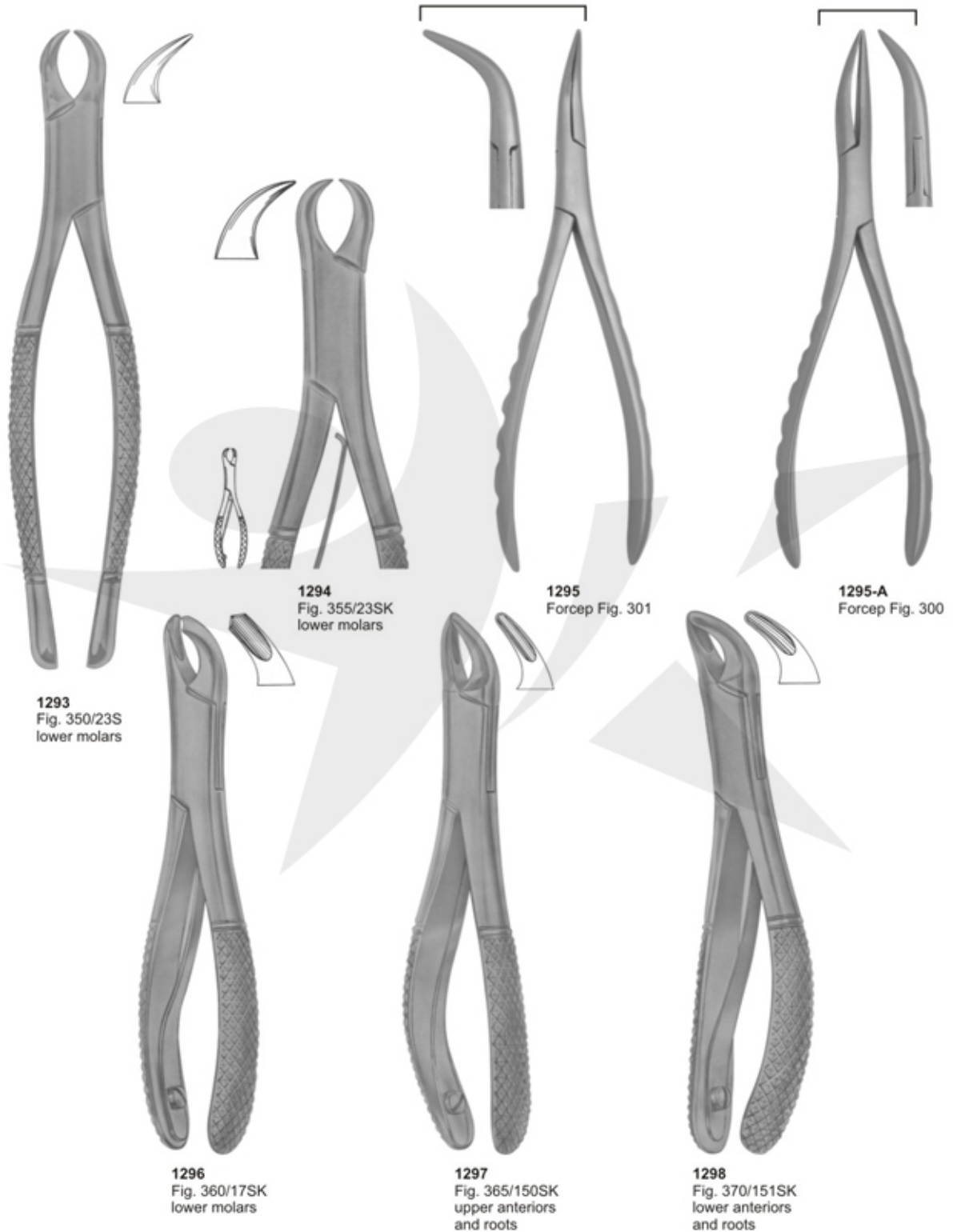



Peristeel Elevators



1299
Molt 9



1300
Allen 9A



1301
Prichard



1302
Seldin



1303
Goldman- Fox 14



1304
West
Dell W2



Elevators

Heidbrink Root - Tip Picks

Root Tip

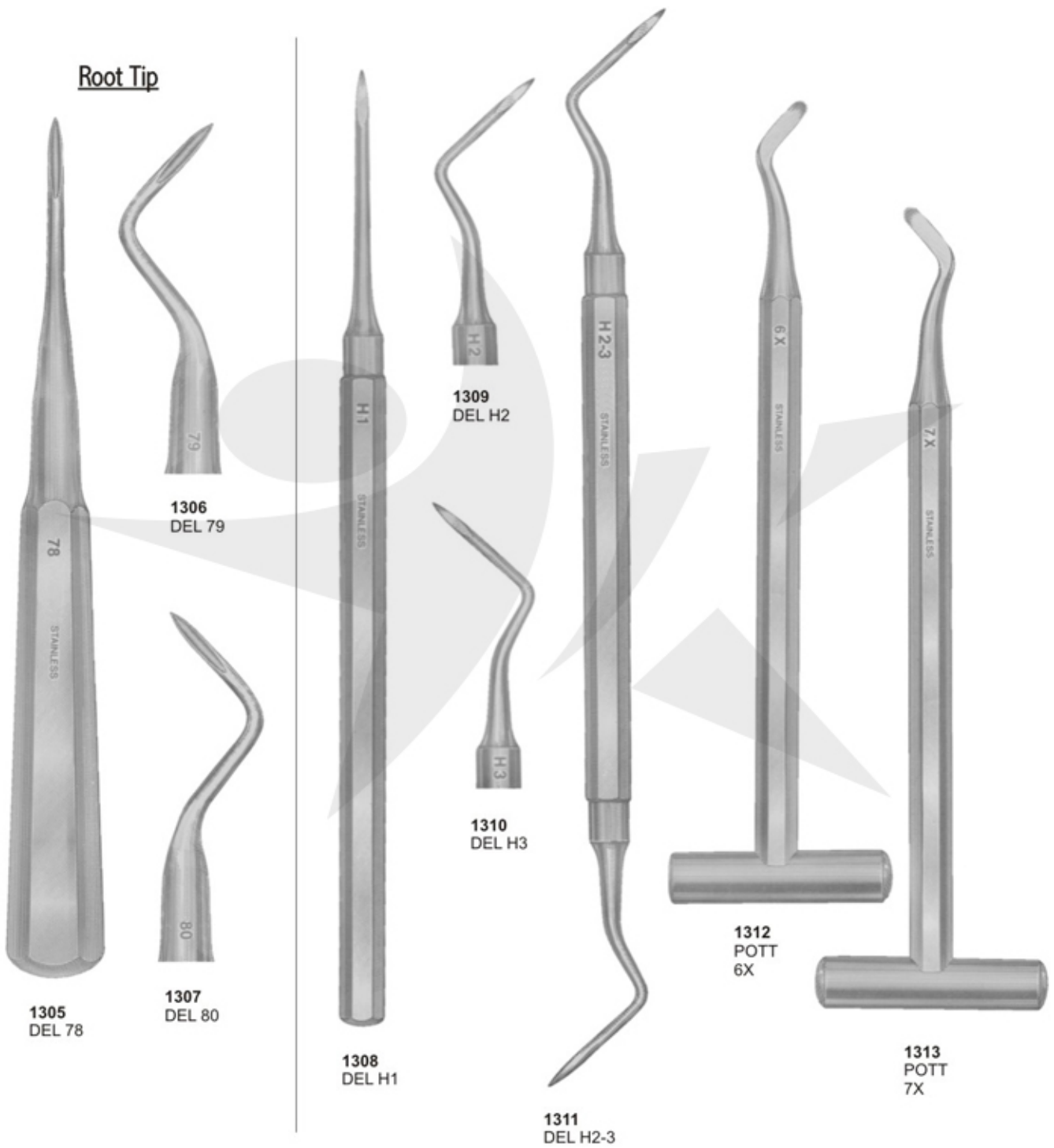



Periosteal Elevators



1314
BUSER



1315
OHI 10



1316
HOWARD 9H



1317
FREER



1318
FREER 15



1319
FREER 16



Root Elevators

lower jaw, left side

lower jaw, right side



1320
BEIN
Fig. 4



1331



1332

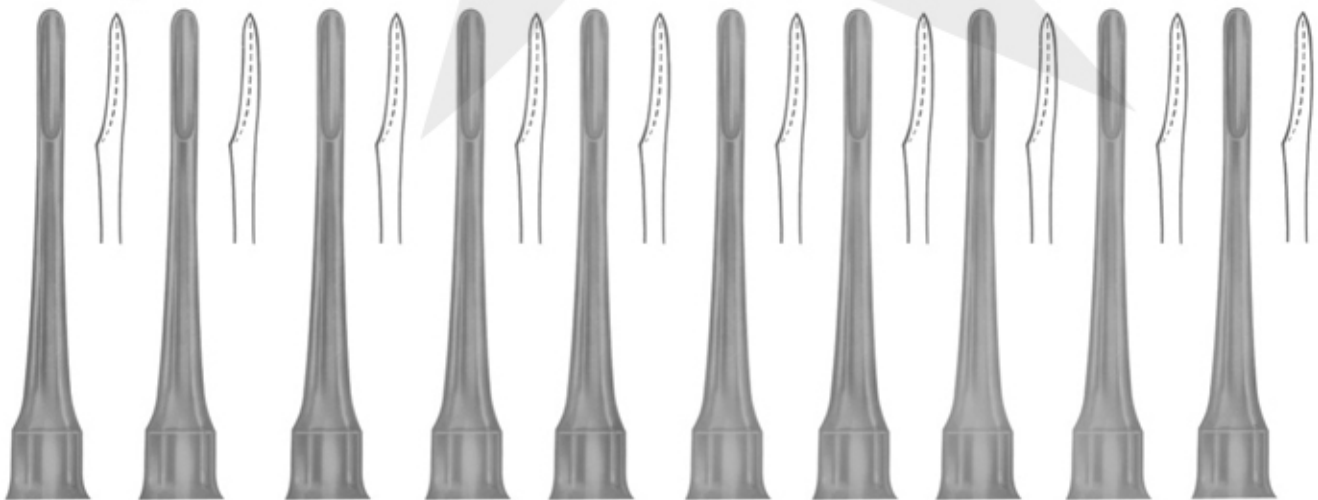

1321
BEIN
1.0 mm

1322
BEIN
1.5 mm

1323
BEIN
2.0 mm

1324
BEIN
2.5 mm

1325
BEIN
3.0 mm

1326
BEIN
3.5 mm

1327
BEIN
4.0 mm

1328
BEIN
4.5 mm

1329
BEIN
5.0 mm

1330
BEIN
5.5 mm



Root Elevators

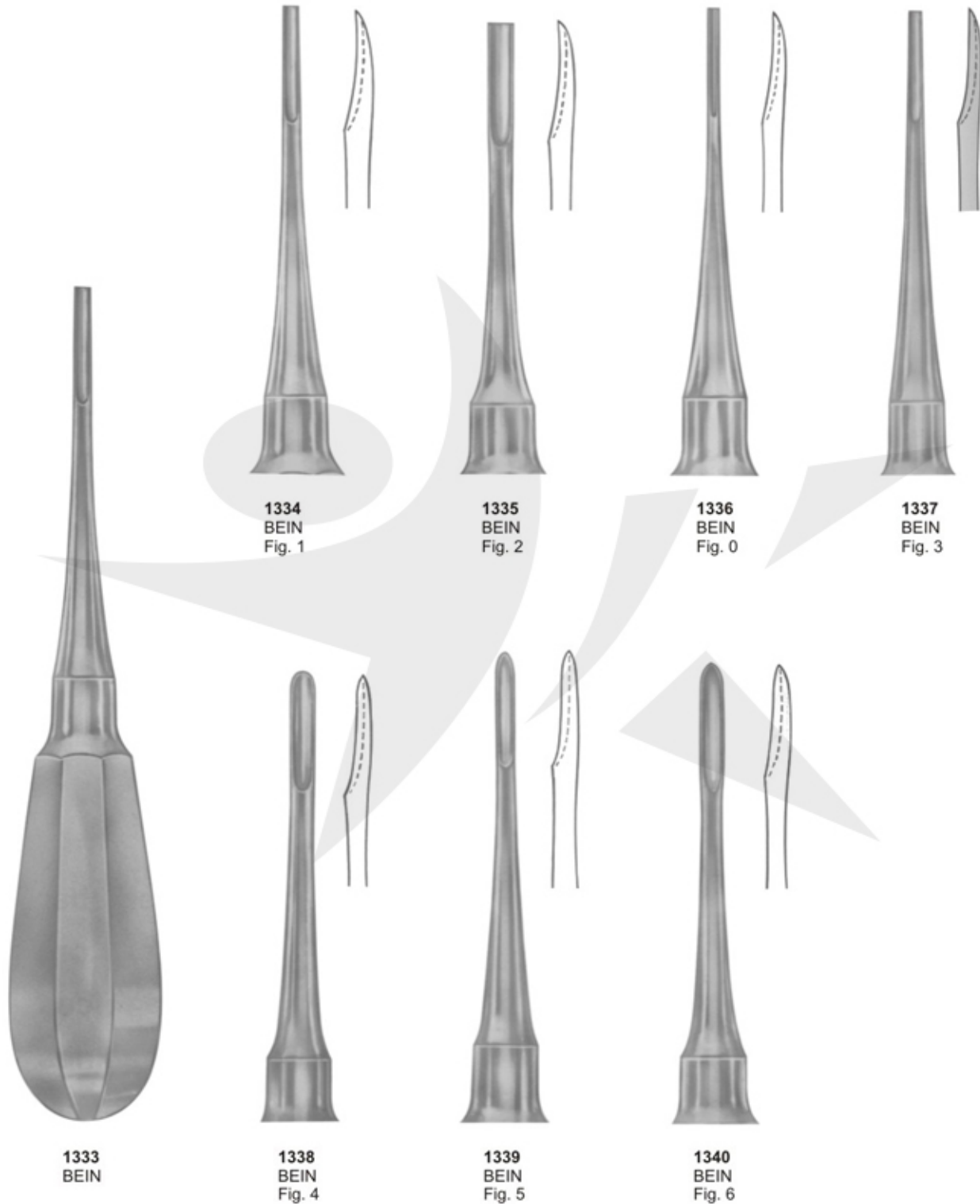



Root Elevators



**1341
CRYER**
Fig. 3



**1342
CRYER**
Fig. 4



**1343
CRYER**
Fig. 12



**1344
CRYER**
Fig. 27



**1345
CRYER**
Fig. 28



**1346
CRYER**
Fig. 27S



**1347
CRYER**
Fig. 28S



**1348
SELDIN**
Fig. 2



**1349
SELDIN**
Fig. 3



**1350
SELDIN**
Fig. 4L



**1351
SELDIN**
Fig. 4R



**1352
SELDIN**
Fig. 1L



**1353
SELDIN**
Fig. 1R



Swa Elevators & Root Screws



Root Screws





Root Elevators

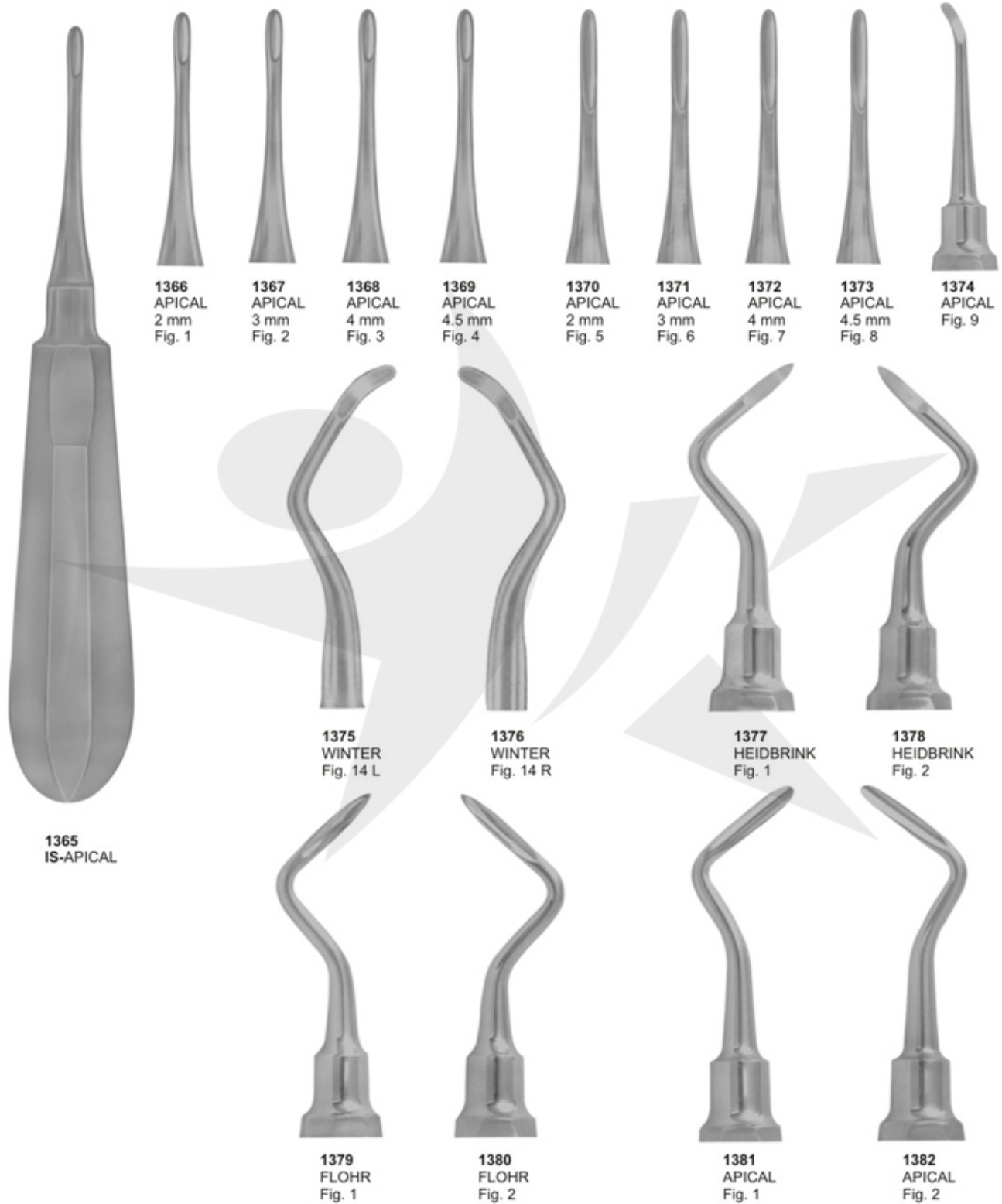



Root Elevators

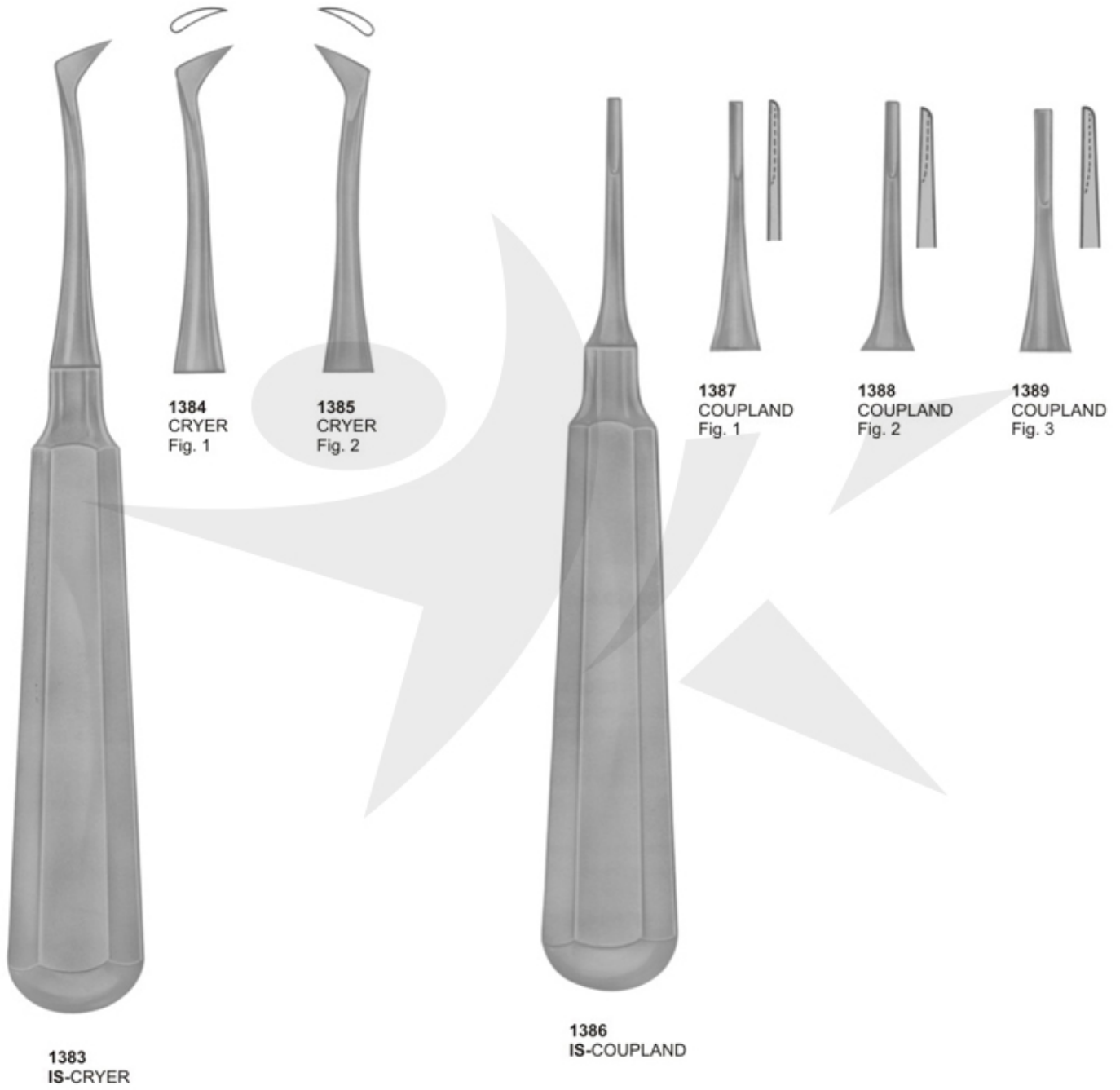



Root Elevators



1390
Fig. 1



1391
Fig. 2



1392
Fig. 3



1393
FLOHR
Fig. 1



1394
FLOHR
Fig. 2



1395
FLOHR
Fig. 3



Root Elevators



1396
KOPP
Fig. 1



1397
KOPP
Fig. 2



1403
KOPP
Fig. 1



1404
KOPP
Fig. 2



1396
KOPP



1398
KOPP
Fig. 3



1399
KOPP
Fig. 4



1402
KOPP



1405
KOPP
Fig. 3



1406
KOPP
Fig. 4



1400
KOPP
Fig. 5



1401
KOPP
Fig. 6



Root Elevators



**1407
HYLIN
Fig. 1**

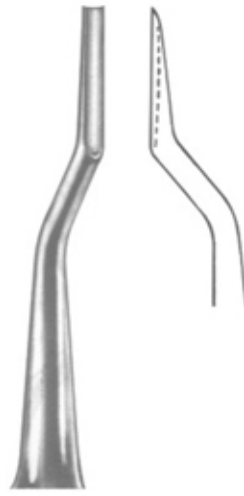

**1409
BEIN
Fig. 1**

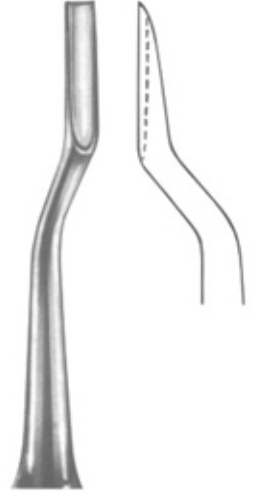

**1410
BEIN
Fig. 2**



**1407
HYLIN**



**1408
HYLIN
Fig. 2**



**1409
BEIN**



**1411
BEIN
Fig. 3**

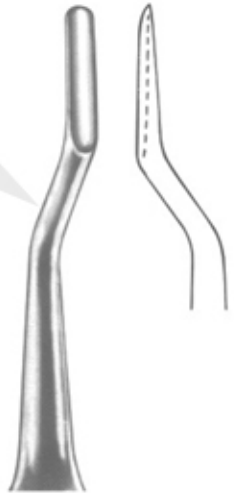

**1412
BEIN
Fig. 4**



Root Elevators

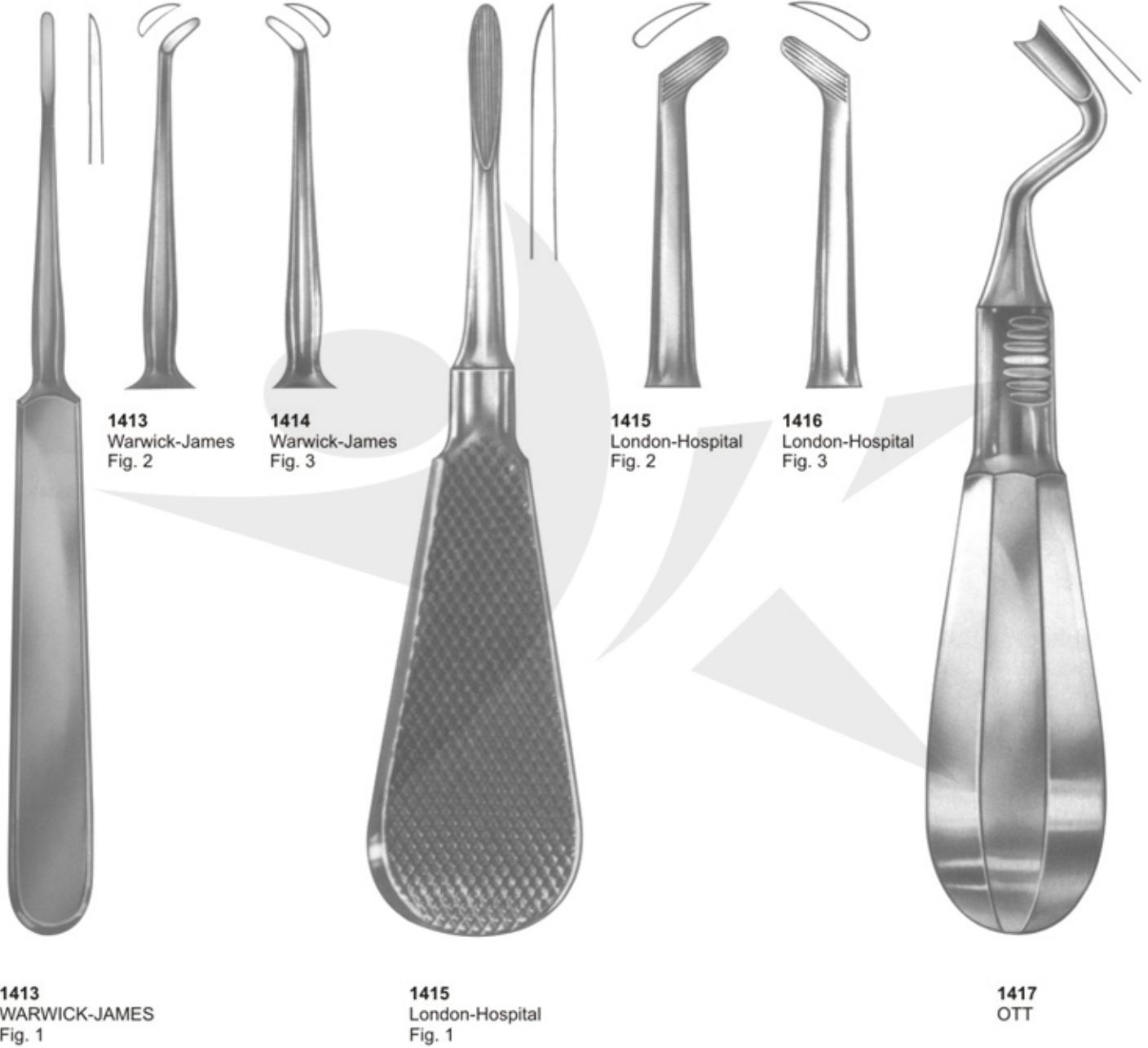



Root Elevators



1418
CHOMPRET
Fig. 1



1419
CHOMPRET
Fig. 2



1420
CHOMPRET
Fig. 3



1421
CHOMPRET
Fig. 4



1423
Fig. 1



1422
Fig. 2



1424
Fig. 1



1425
Fig. 2



1426
APICAL



Root Tip Elevators



1427
IS-Fig. 1



1428
Fig. 2



1429
Fig. 3



1430
HEIDBRINK
Fig. 1



1431
HEIDBRINK
Fig. 2



1432
HEIDBRINK
Fig. 3



1438
MEAD
MD1



1433
LECLUSE



1434
MEAD
MD-5 A



1435
MEAD
MD-6 A



1436
MEAD
MD-7 A



1437
MEAD
MD-8



Root Elevators



1439
WINTER
Fig. 1L



1440
WINTER
Fig. 1R



1441
WINTER
Fig. 2L



1442
WINTER
Fig. 2R

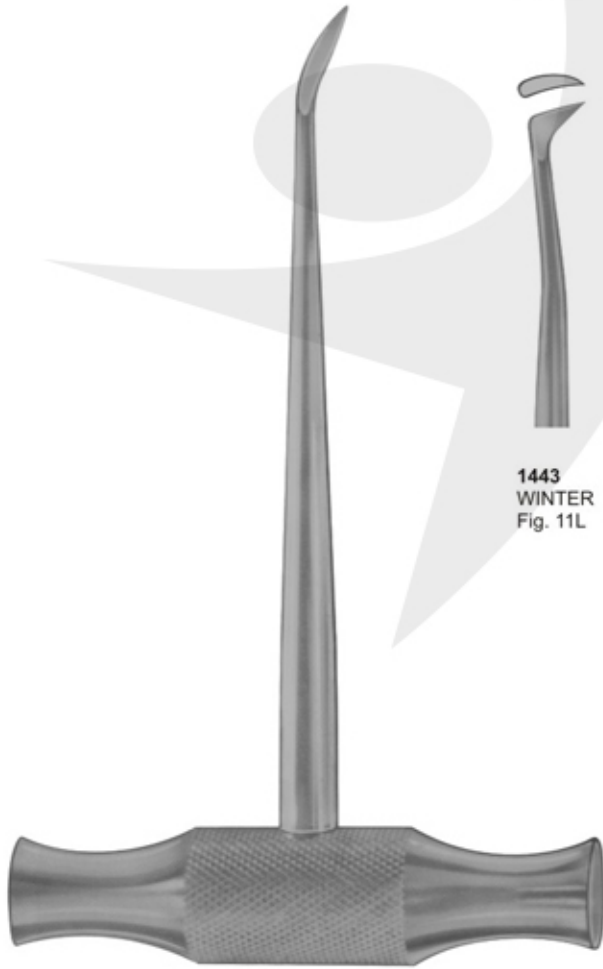

1439
WINTER



1443
WINTER
Fig. 11L



1444
WINTER
Fig. 11R



1445
WINTER
Fig. 12L



1446
WINTER
Fig. 12R



1447
WINTER
Fig. 14L



1448
WINTER
Fig. 14R



Root Elevators



1449
BARRY
Fig. 1



1450
BARRY
Fig. 2



1451
BARRY
Fig. 3



1452
BARRY
Fig. 4



1449
BARRY



1453
BARRY
Fig. 11



1454
BARRY
Fig. 12



1455
BARRY
Fig. 17



1456
BARRY
Fig. 18



Root Elevators



1458
CRYER
Fig. 26



1459
SELDIN
Fig. 27



1460
CRYER
Fig. 28



1461
CRYER
Fig. 29



1462
HEIDBRINK
Fig. 22



1463
HEIDBRINK
Fig. 23

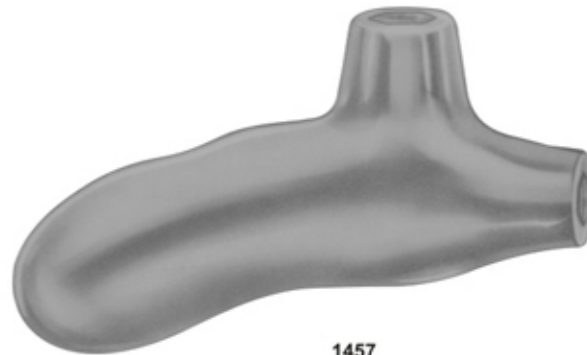

1457



Root Elevators



1465
KOPP
Fig. 31



1466
KOPP
Fig. 32



1467
KOPP
Fig. 33



1468
KOPP
Fig. 34



1469
KOPP
Fig. 35



1470
KOPP
Fig. 44

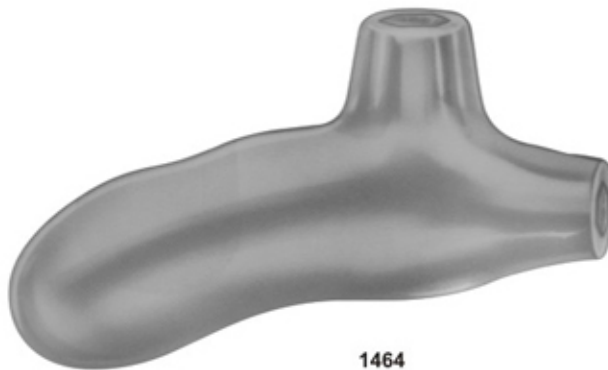

1464



Root Elevators



1472
HEIDBRINK
Fig. 10



1473
WINTER
Fig. 11



1474
WINTER
Fig. 12



1475
BARRY
Fig. 17



1476
BARRY
Fig. 18



1477
BARRY
Fig. 20



1471

Root Elevators according to Dr. Sader,
with interchangeable working tips



1478



1479



1480



Elevators Plastic Handle

1481
Root Elevator, Plastic Handle, Set of 10 Pcs

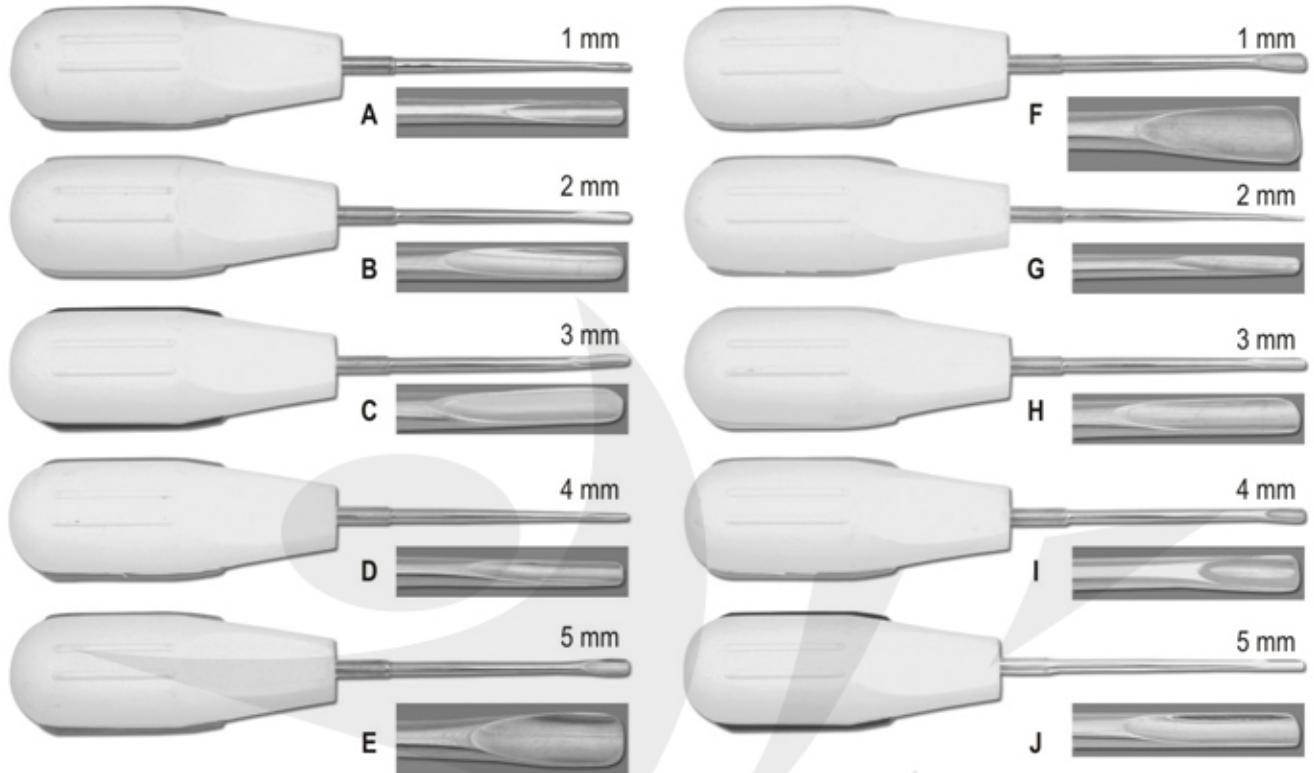

1482
Root Elevator, Plastic Handle, Set of 5 Pcs

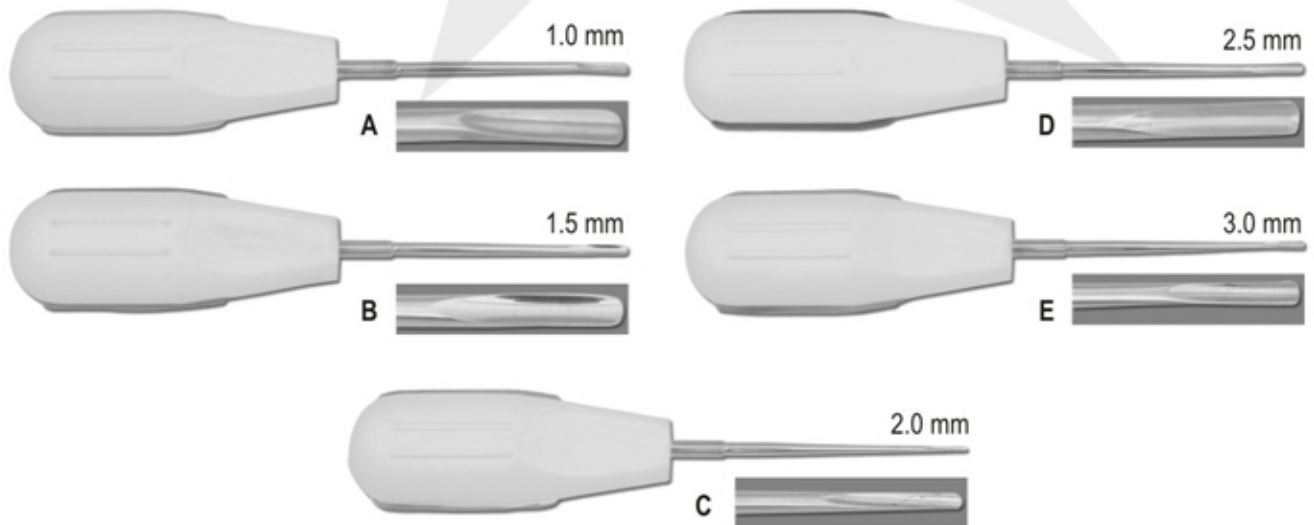



Scalpel Handles



1483

Scalpel Handle Angle Of Blade Adjusts To Easily Get Around Corners
Adjustment Sets Blade From Straight To Back Angled
Locks In At 90°, 60°, 30°, Straight, -30°, -60° Angles



1484

Scalpel Handle
Fig. 5



1485

Scalpel Handle
Curved



1486
Fig. 3L



1487
Fig. 7



1488
Scalpel Handle
Fig. 4L, Curved
20 cm



1489
Fig. 3



1490
Fig. 3G



1491
Fig. 4



1492



1493
Scalpel Handle
4 D 14.0 cm



1494
Mess Holders



1495
Gouge
Blade Handle
Fig. 2 / 11.5 cm



Handles

Handle For Mouth Mirrors, Probes, Explorers, Excavators, Carvers, Curettes & Scalars



1496
Handle No. 2 Standard Single Ended



1497
Handle Single Ended



1498
Handle Single Ended



1499
Handle Single Ended

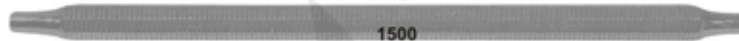

1500
Octagonal Double Ended



1501
Octagonal Double Ended



1502
Octagonal Double Ended



1503
Handle No. 2 (Standard Double Ended)



1504
Octagonal Double Ended



1505
Tactile Tone Double Ended



1506
Tactile Tone Double Ended



1507
Tactile Tone Double Ended



1508
Handle, Double Ended



1509
Double Ended



1510
Tactile Tone Double Ended



1511
Tactile Tone Double Ended



Handles & Mouth Mirrors



1512
Hollow Handle
Fig.1



1513
Hollow Handle
Fig.2



1513-A

Mouth Mirrors, Magnifying 1513-A Plain 1512-B

Fig. 00	Ø 8 mm
Fig. 0	Ø 10 mm
Fig. 1	Ø 14 mm
Fig. 2	Ø 16 mm
Fig. 3	Ø 18 mm
Fig. 4	Ø 20 mm
Fig. 5	Ø 22 mm
Fig. 6	Ø 24 mm
Fig. 7	Ø 26 mm
Fig. 8	Ø 28 mm
Fig. 9	Ø 30 mm
Fig. 10	Ø 32 mm

Mouth Mirrors

Plane

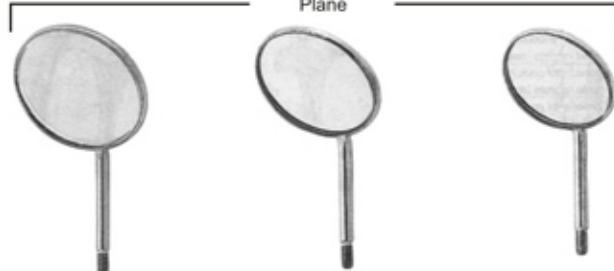

1514
Fig.6
Ø 26 mm

1515
Fig.5
Ø 24 mm

1516
Fig.4
Ø 22 mm

Magnifying



1517
Fig.6
Ø 26 mm

1518
Fig.5
Ø 24 mm

1519
Fig.4
Ø 22 mm

Front surface

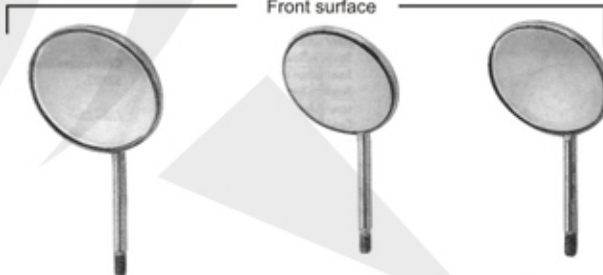

1520
Fig.6
Rhodium
Ø 26 mm
Front surface

1521
Fig.5
Rhodium
Ø 24 mm
Front surface

1522
Fig.4
Rhodium
Ø 22 mm
Front surface

Plane

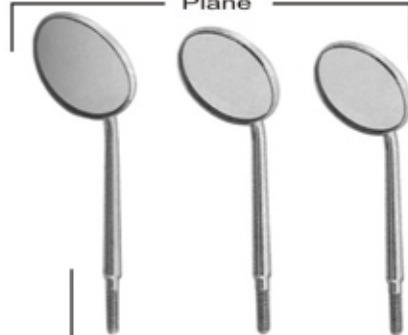

1523
Fig.6
Ø 26 mm

1524
Fig.5
Ø 24 mm

1525
Fig.4
Ø 22 mm

With cone - socket

Magnifying



1526
Fig.6
Ø 26 mm

1527
Fig.5
Ø 24 mm

1528
Fig.4
Ø 22 mm



Mirror Handle, Mouth Mirrors



1529



1530



1531



1532



1533



1534

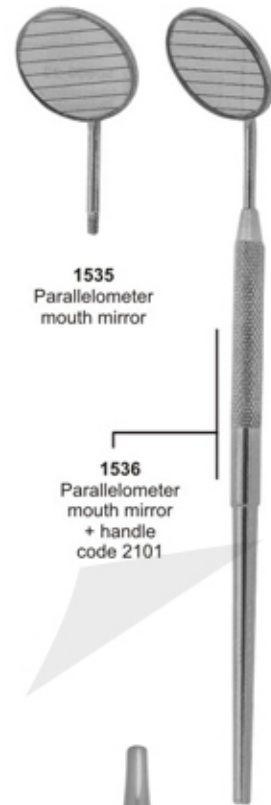

1535
Paralleliometer
mouth mirror

1536
Paralleliometer
mouth mirror
+ handle
code 2101



1537
Tactile Tone
Single Ended



1538
Handle
Thompson
Single Ended



1539
Hollow Handle



1540
Hollow Handle
Stainless
Steel



1541
Cone-socket
Hollow Handle



1542
Hollow Handle



1543
Hollow Handle



Scalers

SCALERS - JAQUETTE

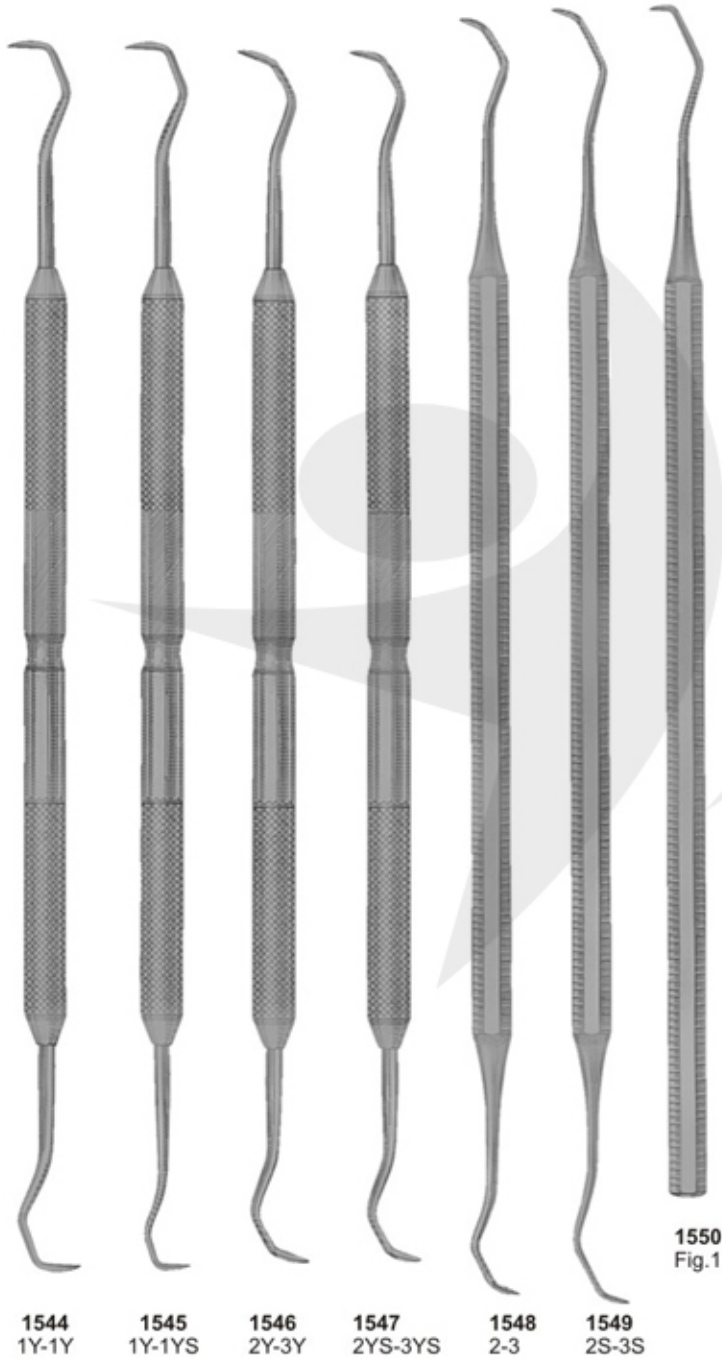

SCALERS - OCTAGONAL

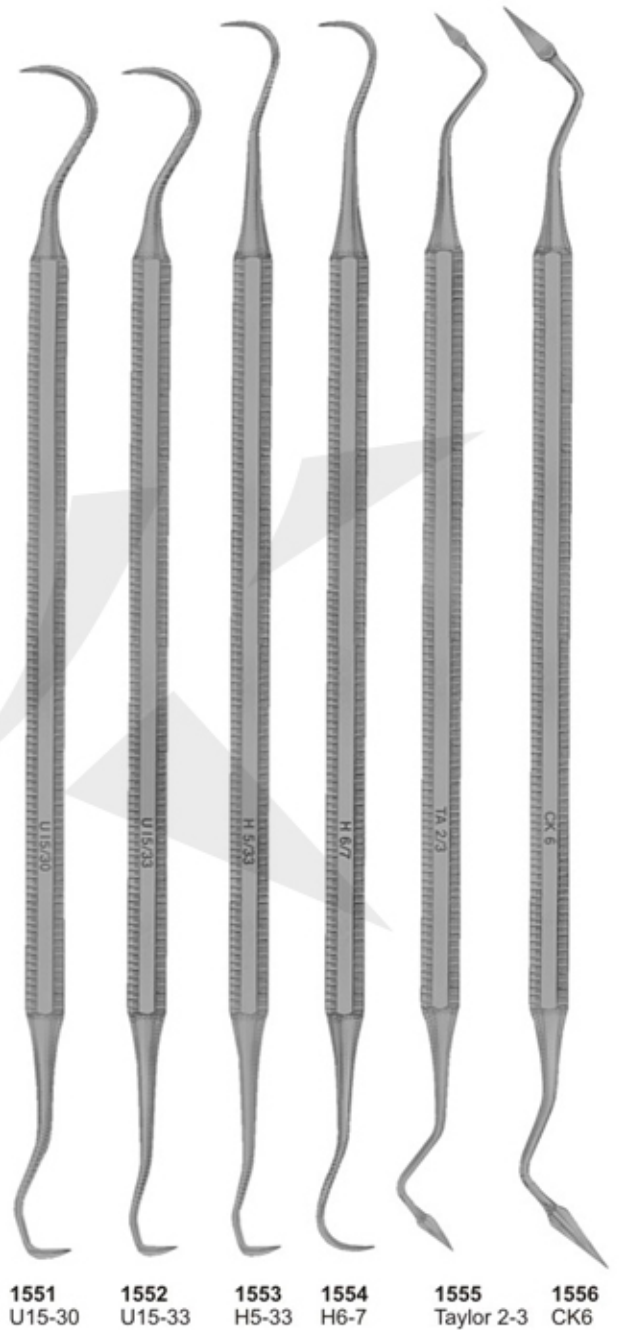



Scalers



1557
U15



1558
No. 3



1559
No. 12



1560
WHITESIDE 1-0

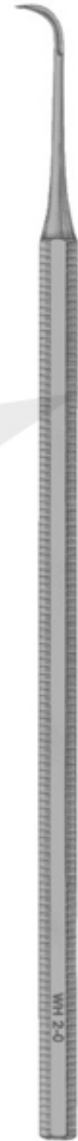

1561
WHITESIDE 2-0



Scalers

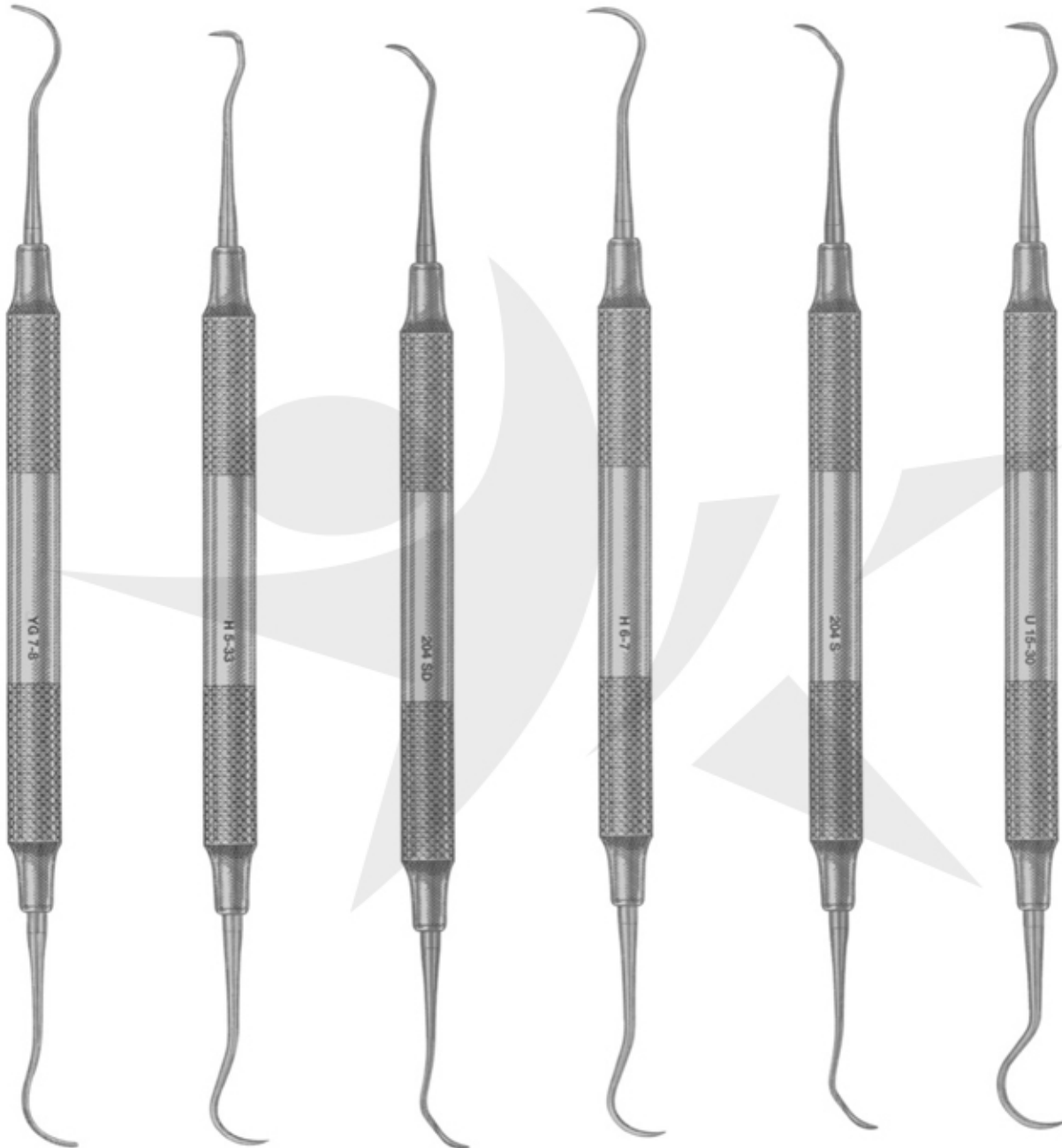

1562
YAOUNGER/GOOD
7-8

1563
H5-33

1564
204SD

1565
H6-7

1566
204S

1567
TOWNER/JAQUETTE
U15-30



Scalers



1568
JAQUETTE (33-U15)



1569
JAQUETTE
2Y-3Y



1570
JAQUETTE
30-U15



1571
JAQUETTE
2YS-3YS



1572
JAQUETTE
33-H5



1573
YOUNGER/GOOD
7-8



1574
204S

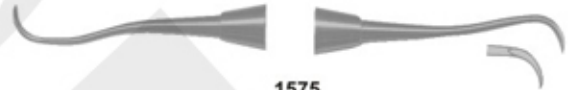

1575
204SD



1576
H6-7



1577
JAQUETTE
2S-3S



1578
JAQUETTE
1Y-1YS



1579
JAQUETTE
2-3



Scalers



1580
JAQUETTE (33-U15)



1581
S204



1583
S204S

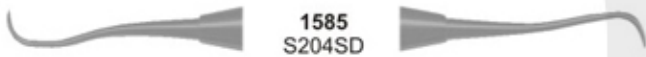

1585
S204SD

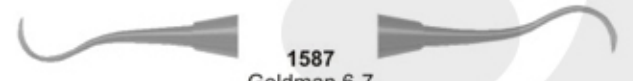

1587
Goldman 6-7



1589
Goldman Fox 21



1591
H5-U15



1593
Jaquette 34-35



1595
Thompson Jr.

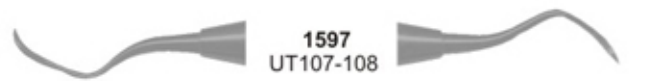

1597
UT107-108



1599
UP128

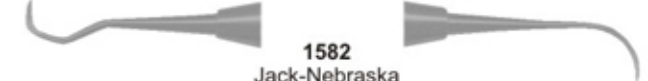

1582
Jack-Nebraska

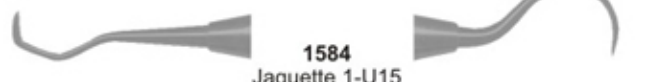

1584
Jaquette 1-U15



1586
Jaquette 2-3

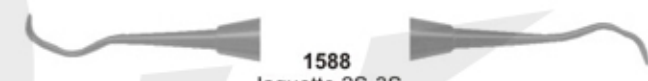

1588
Jaquette 2S-3S



1590
Jaquette 30-U15



1592
Jaquette 30-33



1594
Jaquette 31-32



1596
Jaquette 33-H5



1598
U 6-7



1600
128L



Explorers

Explorers Double Ended - Octagonal

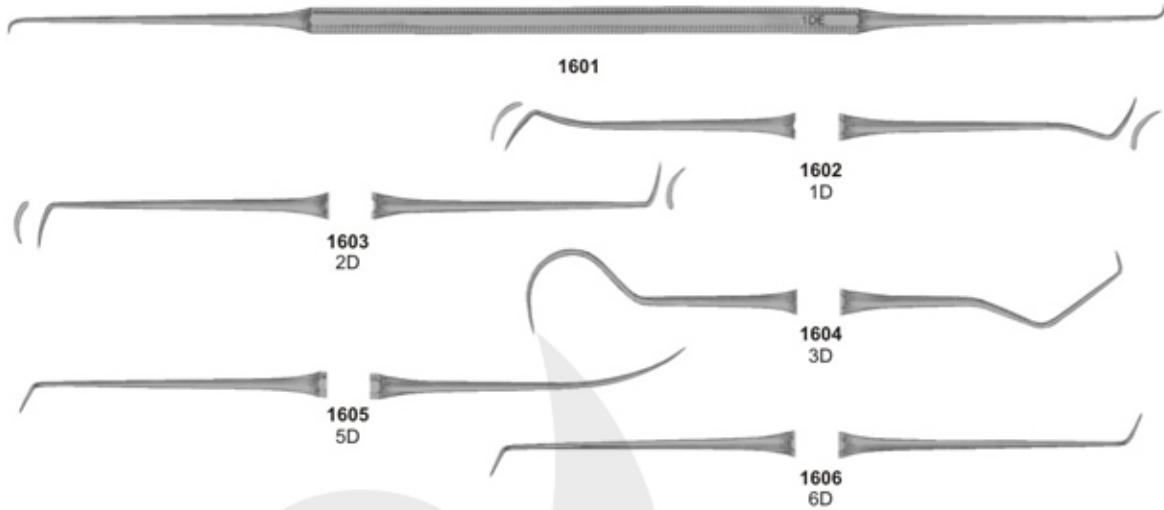

Explorers Double Ended - Standard

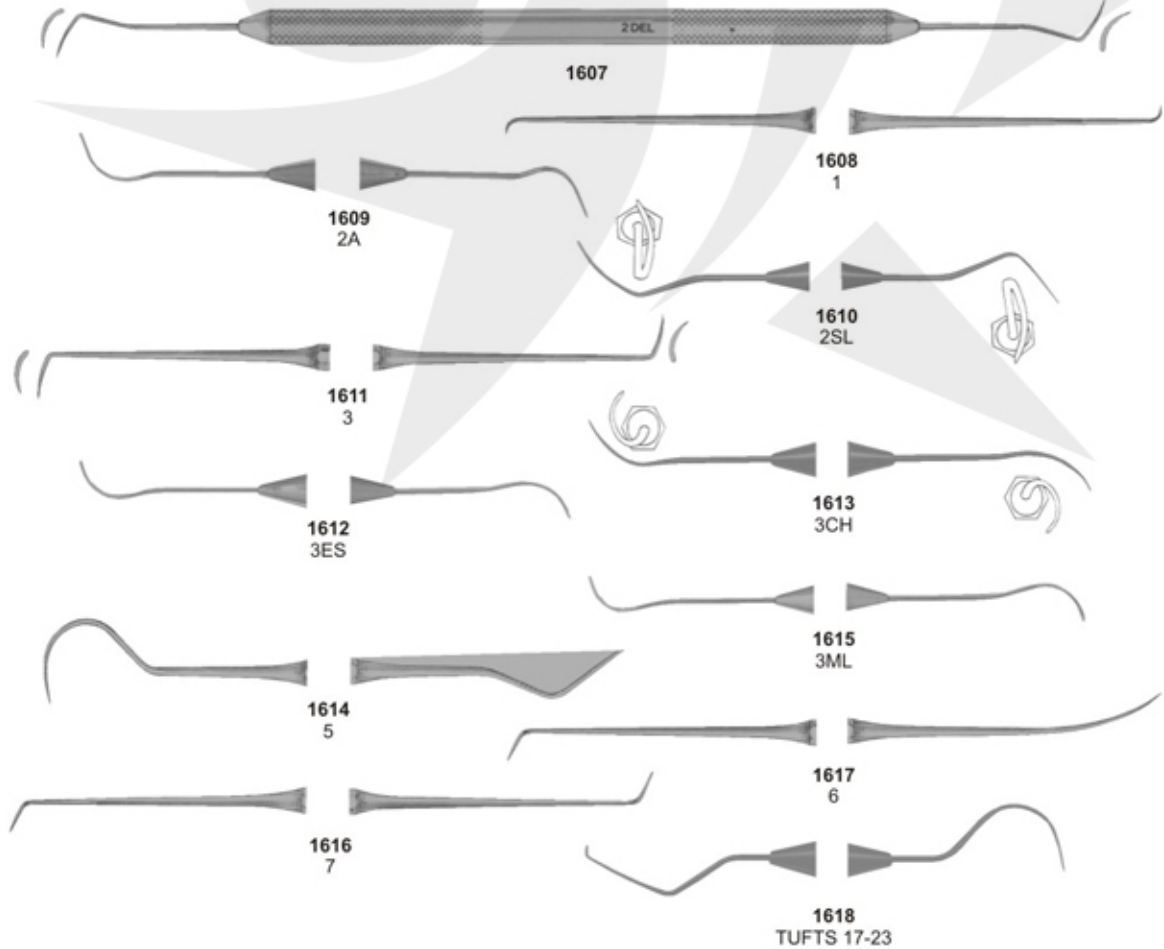



Explorers

Explorers Double Ended Tactile Tone



1619
2A



1620
2



1621
1



1622
2SL



1623
3



1624
3CH



1625
3ES



1626
3ML



1627
5



1628
6



1629
7



1630
16



1631
TUFTS 17/23



Explorers & Probes

Explorers Single Ended - Octagonal

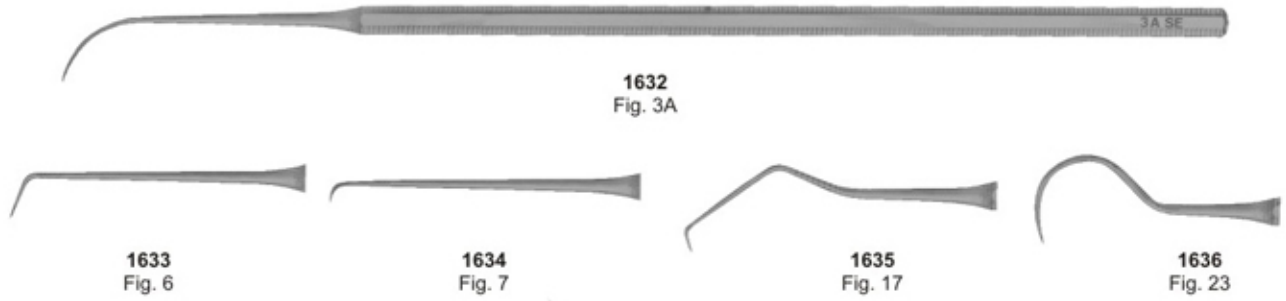

Explorers Single Ended - Standard

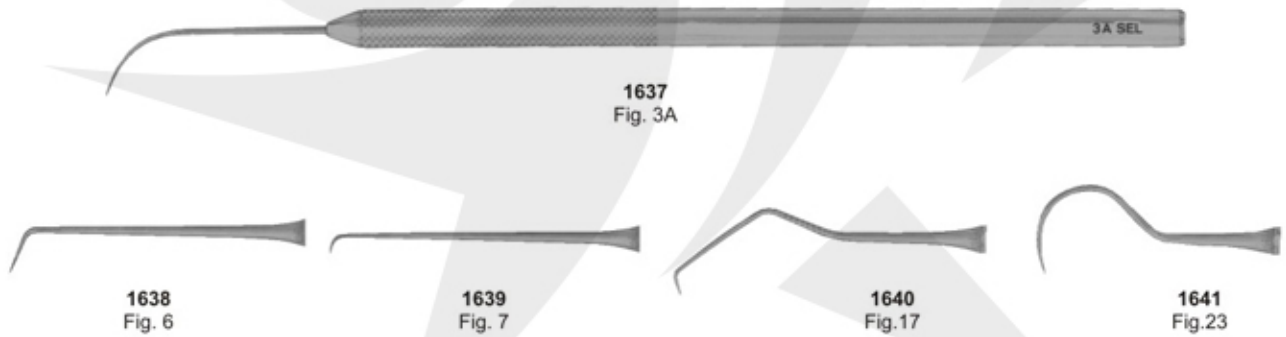

Probe / Explorer - Octagonal

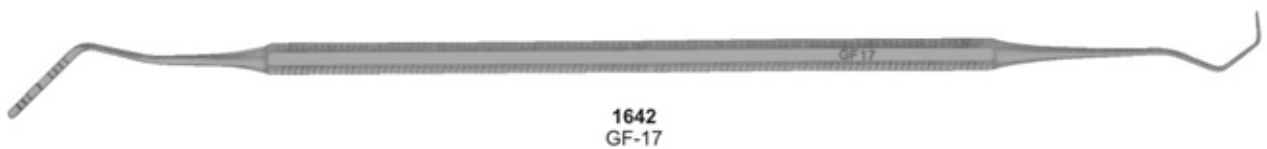

Double Ended Probe - Octagonal

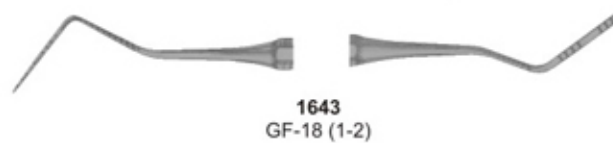



Probes

Probes Double Ended - Standard

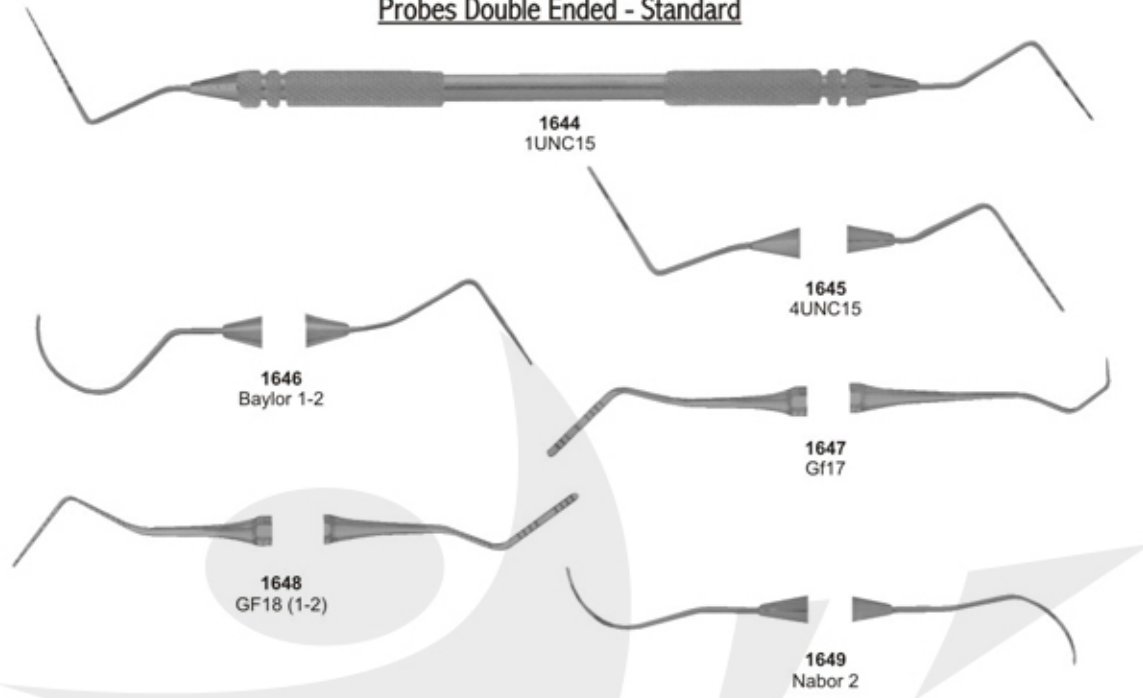

Probes Double Ended - Tactile Tone

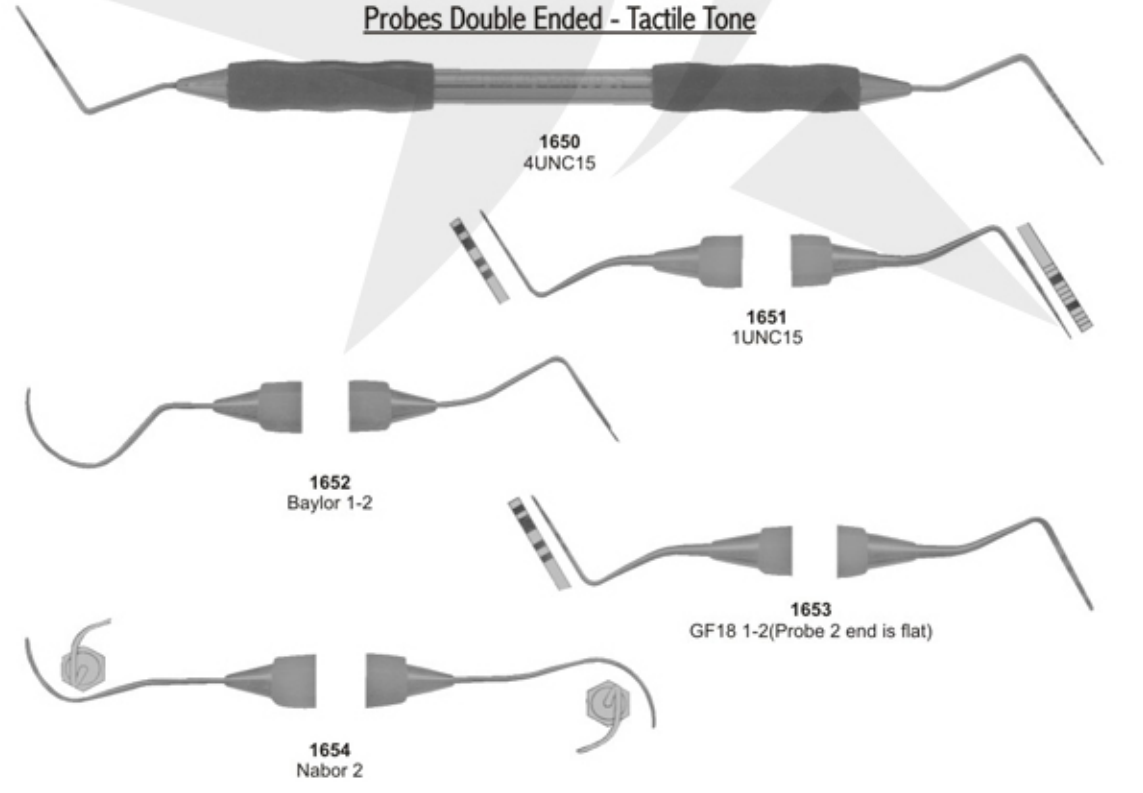



Probes

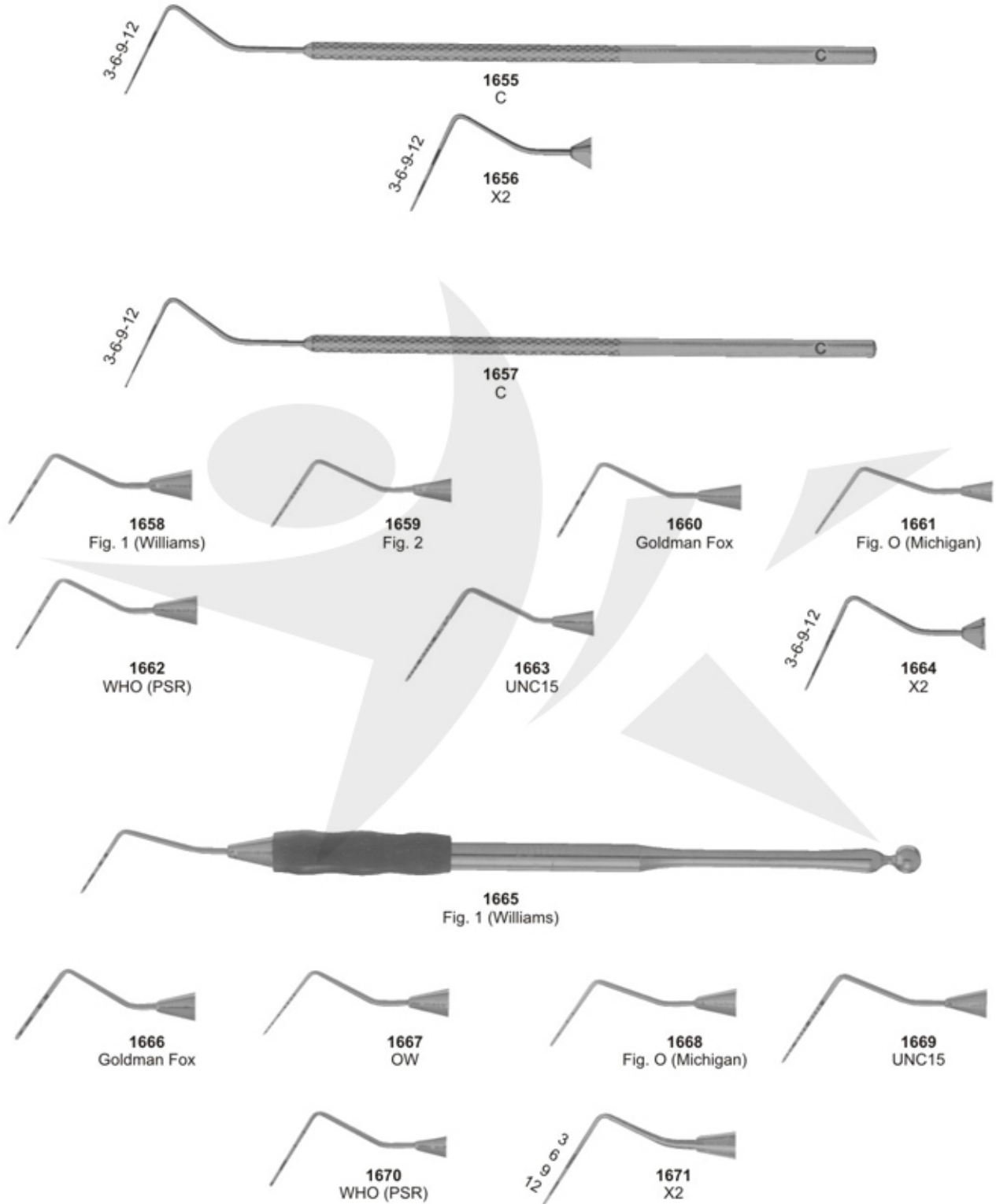



Probes

PROBES DOUBLE ENDED STANDARD

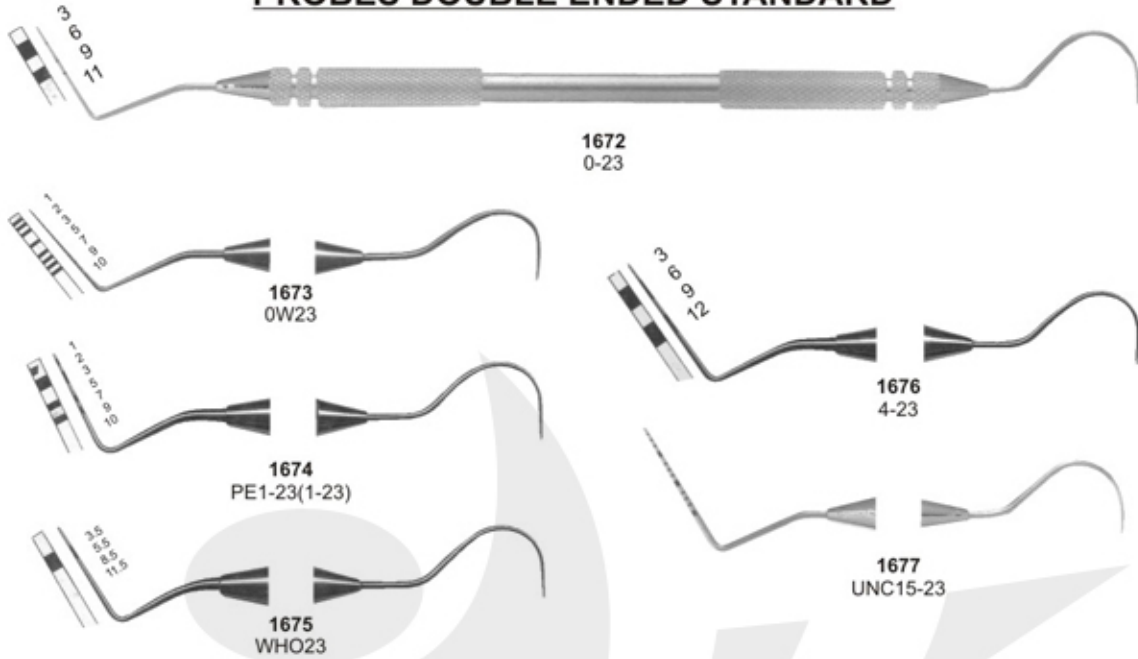

PROBES DOUBLE ENDED TACTILE TONE

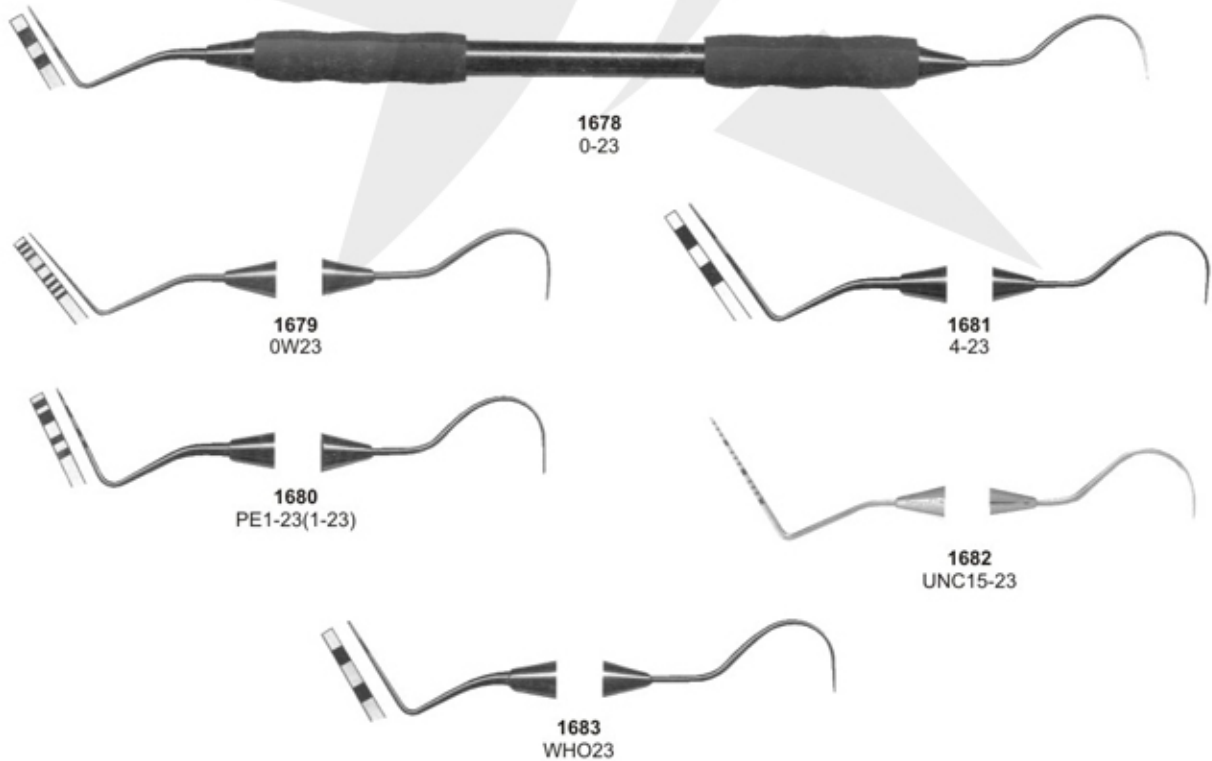



Endodontic Condensers

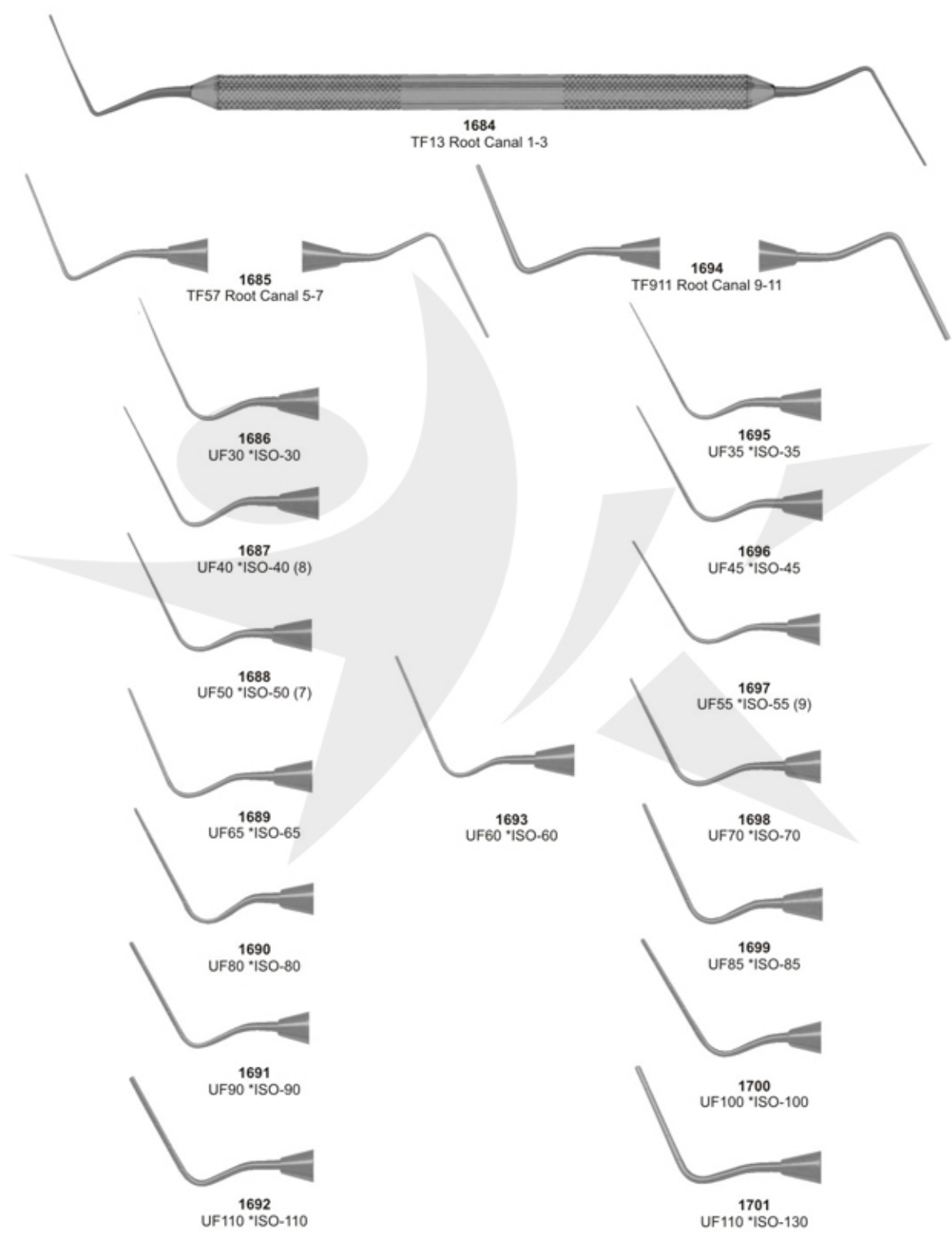



Endodontic Condensers/Spreaders

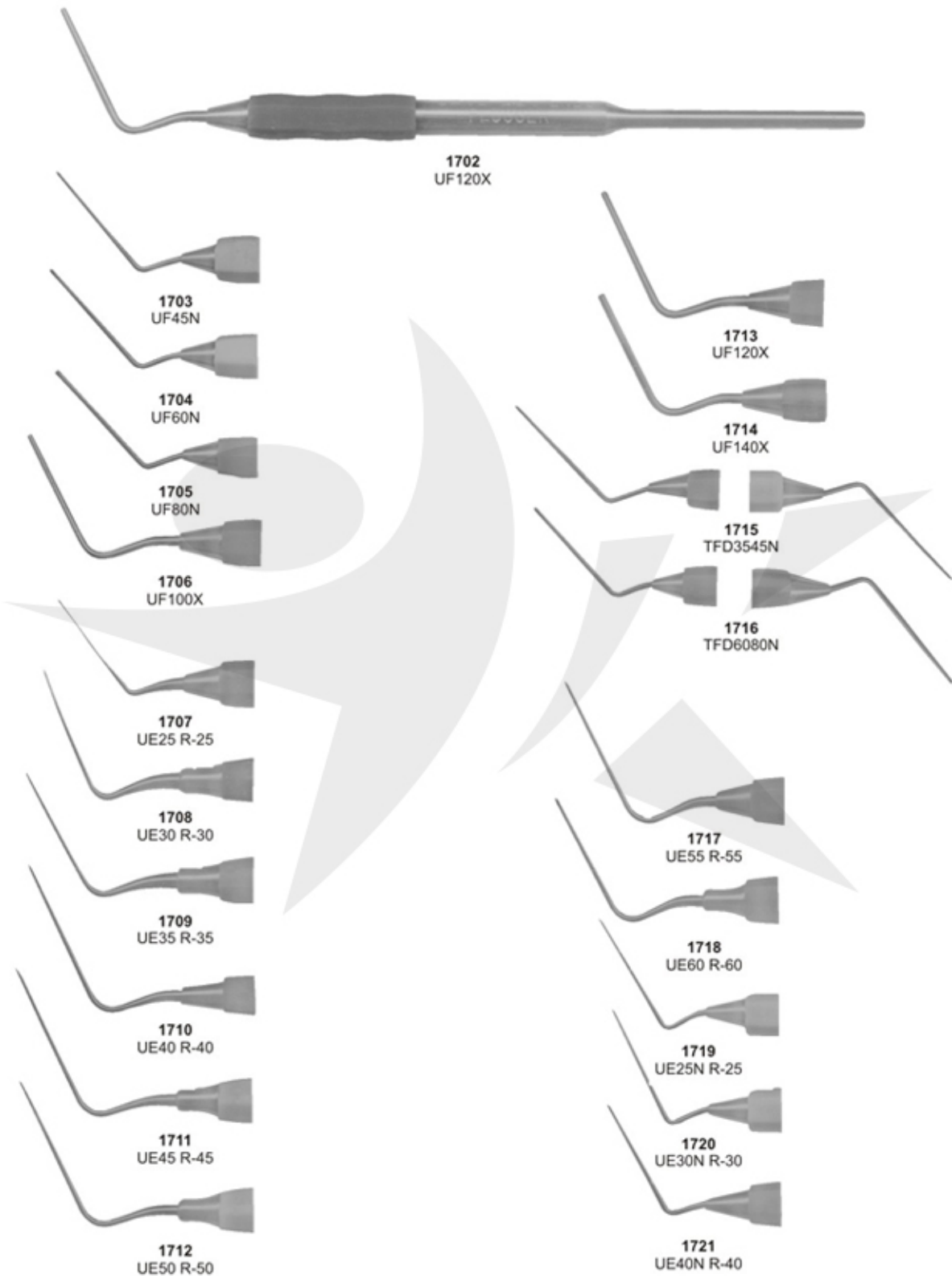



Obturation Instruments

1722
No. D11

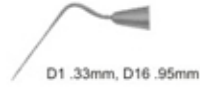

1723
No. D11T



1724
No. KR1



1725
No. 25S

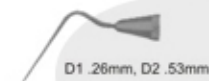

1726
No. W1S



1727
No. W2S

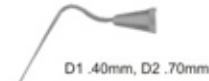

1728
Lucks No.1



1729
Lucks No.2



1730
Lucks No.3



1731
Lucks No.4



1732

No. 5, D(1mm).50mm, .55mm D(5mm)
D(16mm), 85mm, .75mm D(16mm)

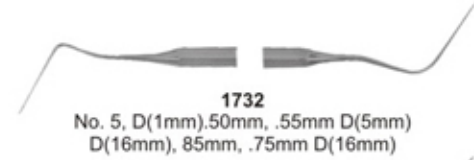

1733

No. 7, D(1mm).70mm, .50mm D(5mm)
D(16mm), 1.00mm, .75mm D(16mm)

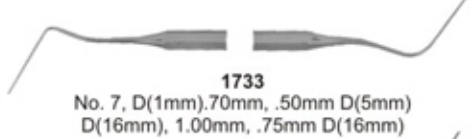

1734

No. 9, D(1mm)1.00mm, .63mm D(5mm)
D(16mm), 1.30mm, .75mm D(16mm)

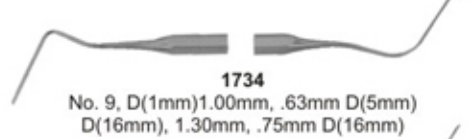

1735

No. 11, D(1mm)1.20mm, .63mm D(5mm)
D(16mm), 1.50mm, .75mm D(16mm)



1736

No.1 (D1 .35mm, D16 .75mm)



1737

No.2 D1 .55mm, D16 .85mm



1738

No.3 D1 .85mm, D16 1.15mm



1739

No.4 D1 1.00mm, D16 1.30mm

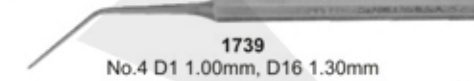

1740

No.1-3 - D1 .25mm/D1 .35mm

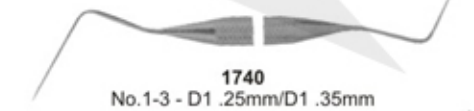

1741

No.3-5 - D1 .35mm/D1 .55mm

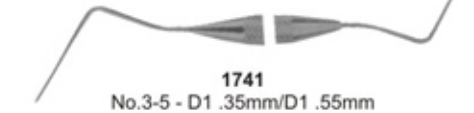

1742

No.5-7 - D1 .55mm/D1 .70mm

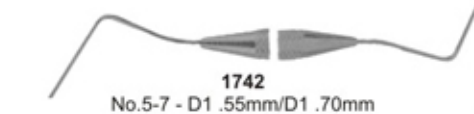

1743

No.9-11 - D1 1.00mm/D1 1.20mm





Excavators

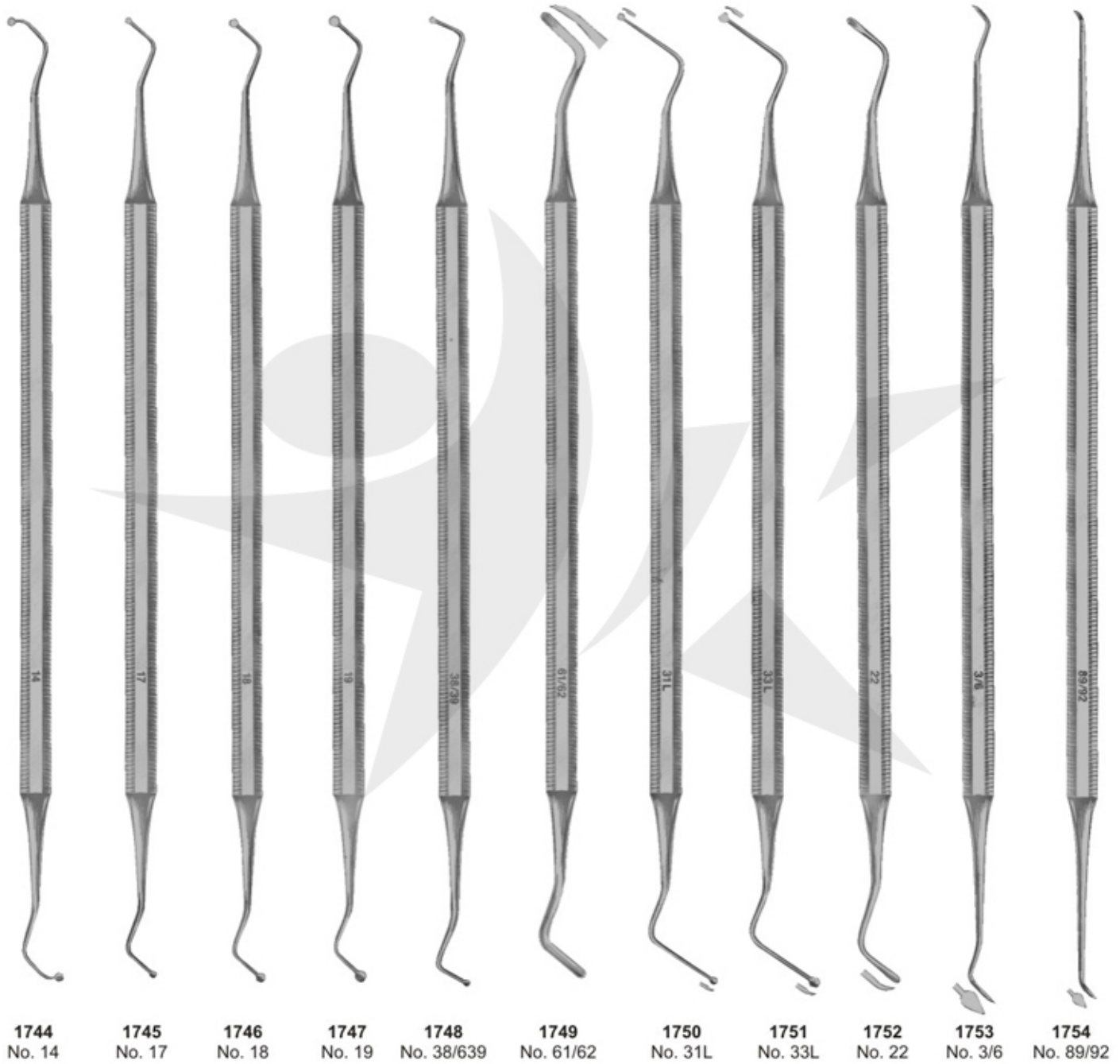



Excavators

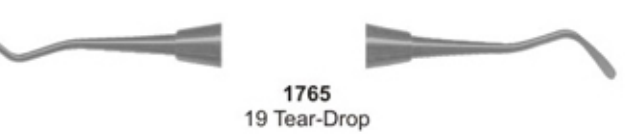
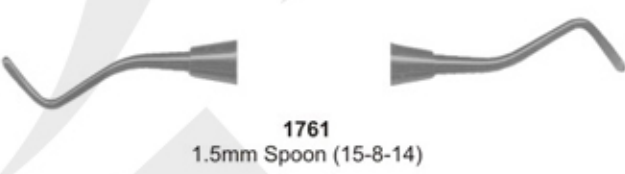
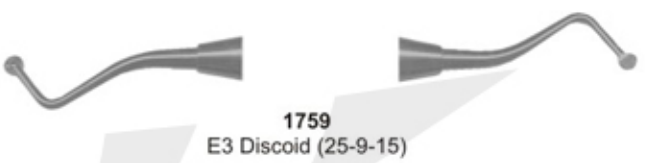
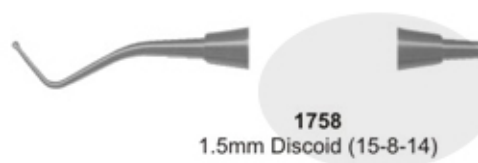
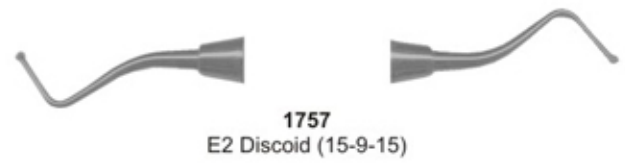
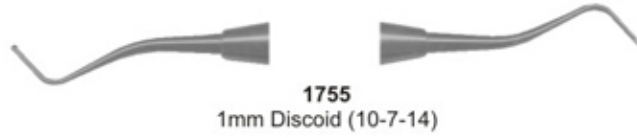



Excavators, Explorer / Probes

Excavators

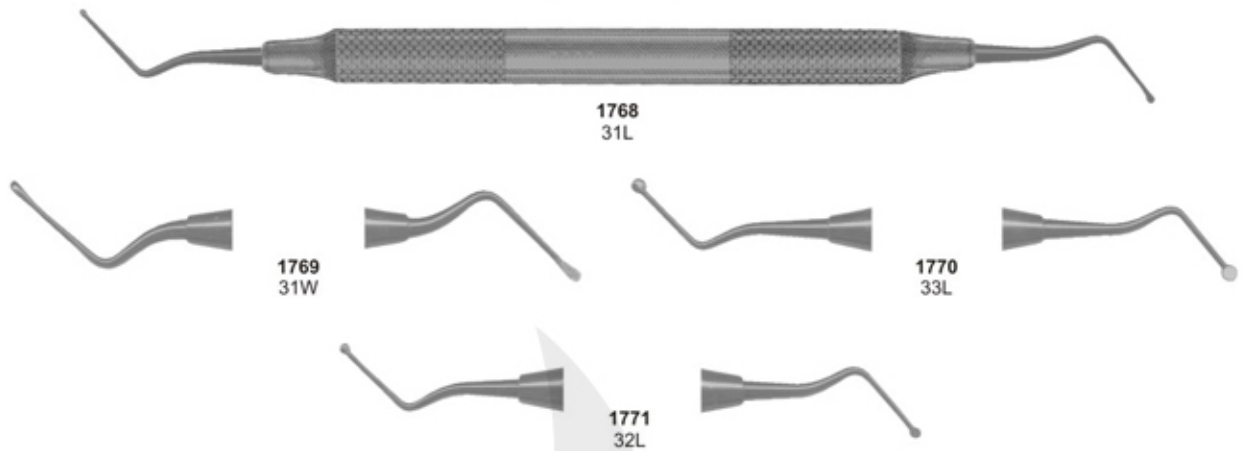

Explorers / Probes

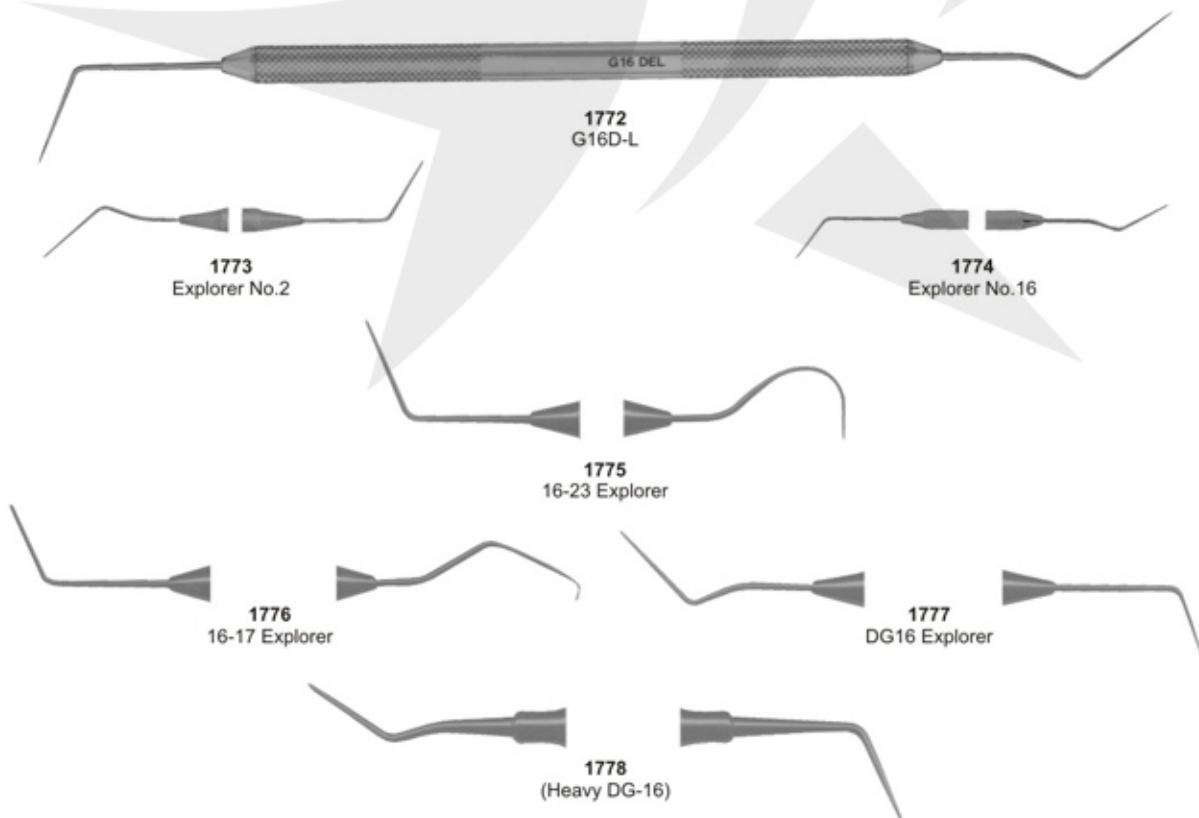



Explorers

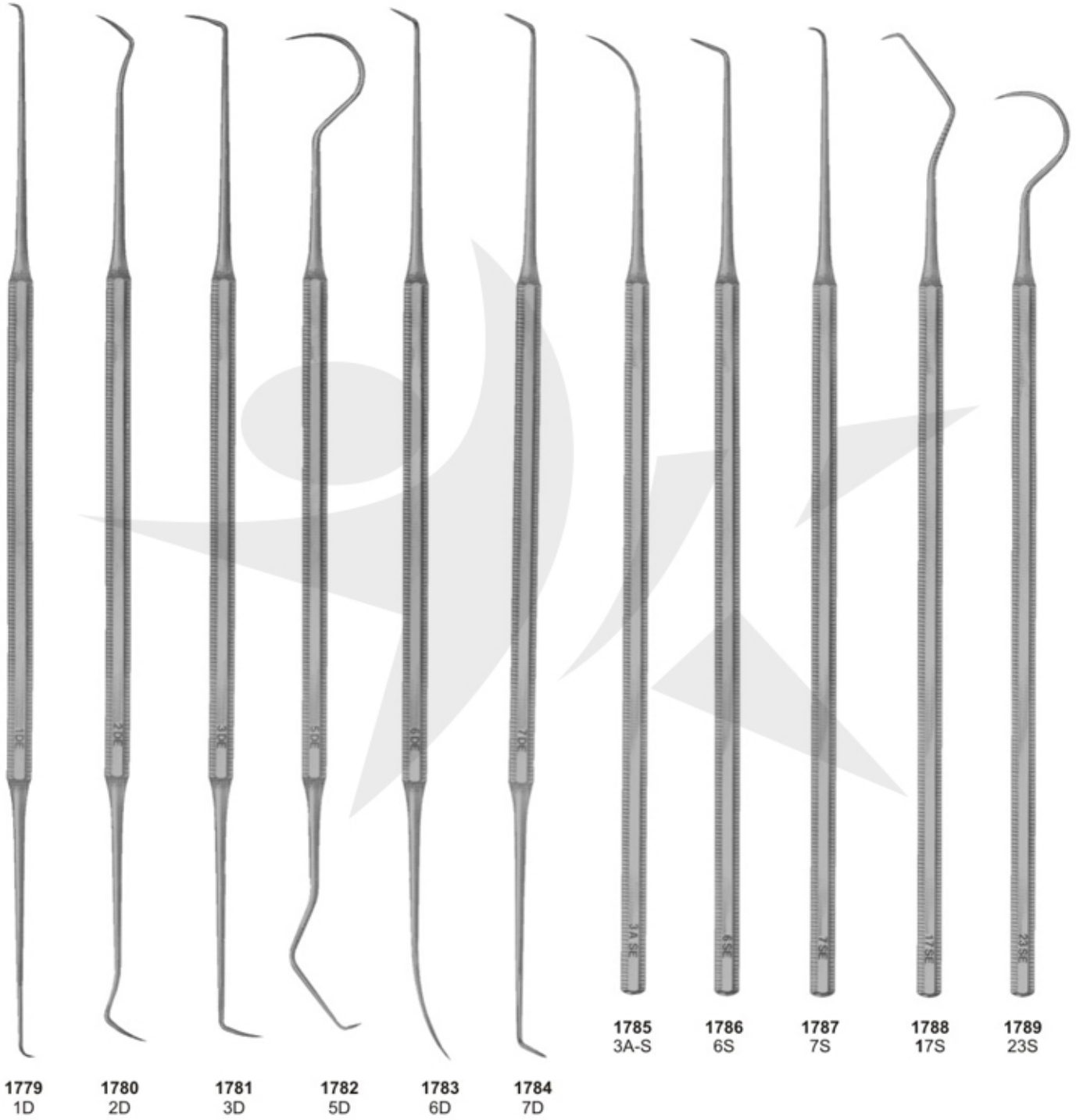



Explorers

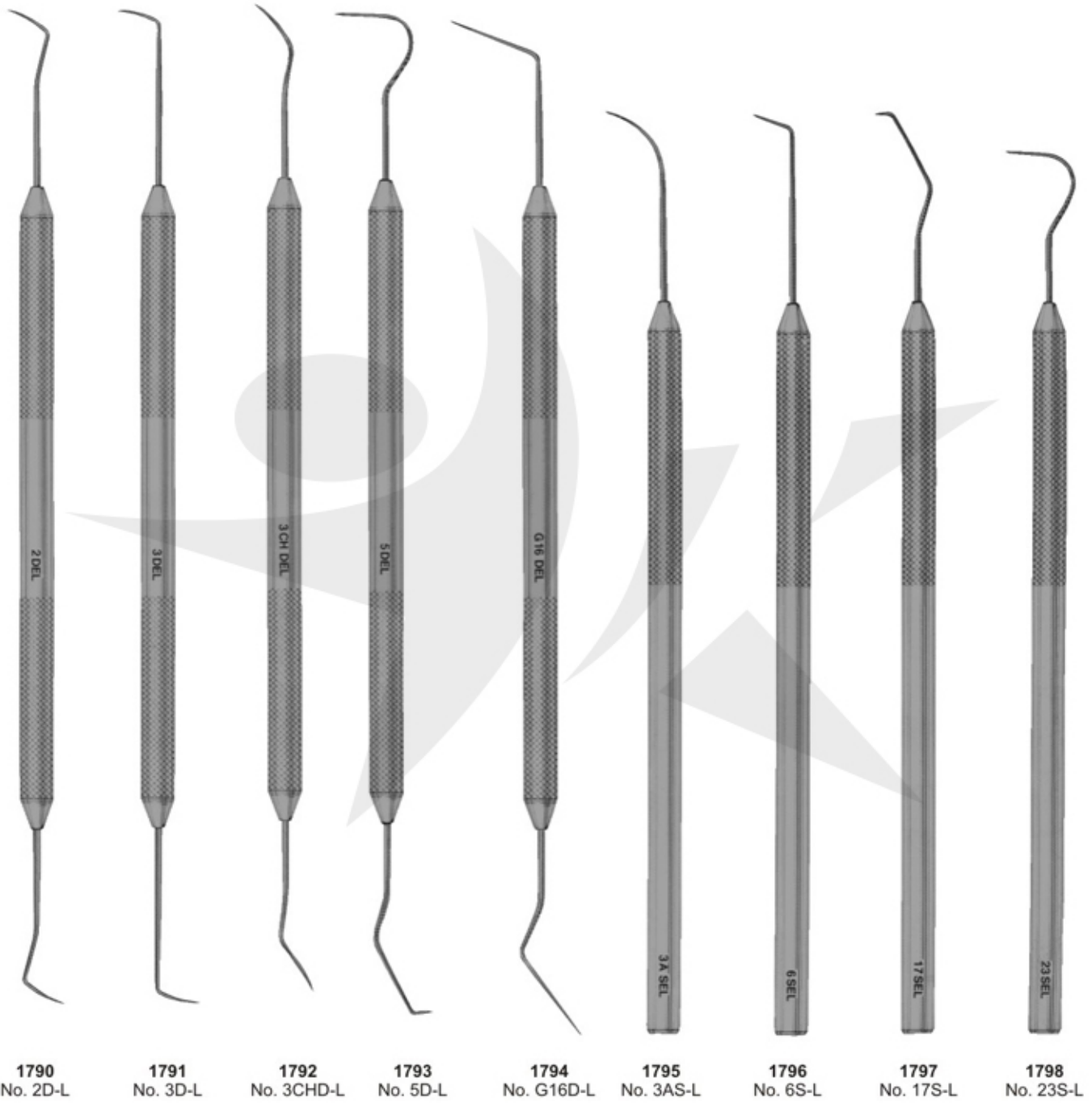



Explorer / Probe Combination

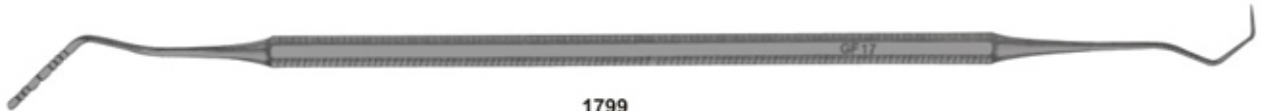

1799
Gf17 Probe/Explorer



1800
PE 1-23 Probe/Explorer

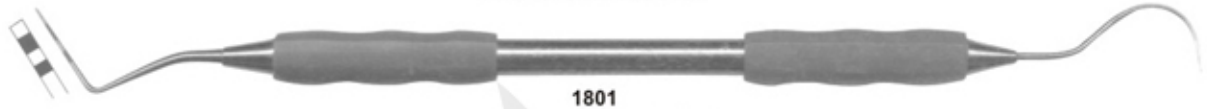

1801
Probe 0 / 23 Explorer (fine)



1802
Probe 1 / 23 Explorer

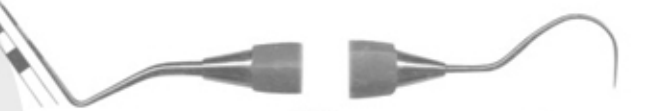

1804
Probe 4 / 23 Explorer



1803
Probe OW / 23 Explorer

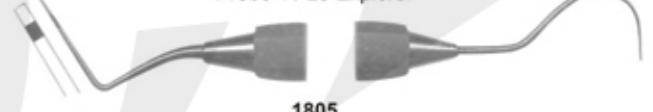

1805
Ball Tip Probe WHO / 23 Explorer

PROBES



1806
Gf18 Probe



1807
"C" Probe



1808
X2 Probe

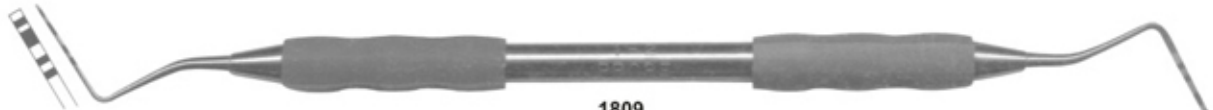

1809
1-2 (Probe 2 end is flat)

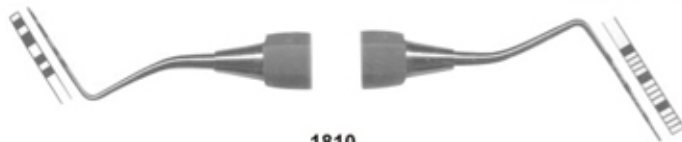

1810
1 UNC 15

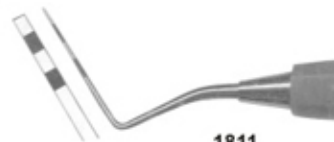

1811
4 SE



Cord Packers, Hatchets, Hoes

CORD PACKERS

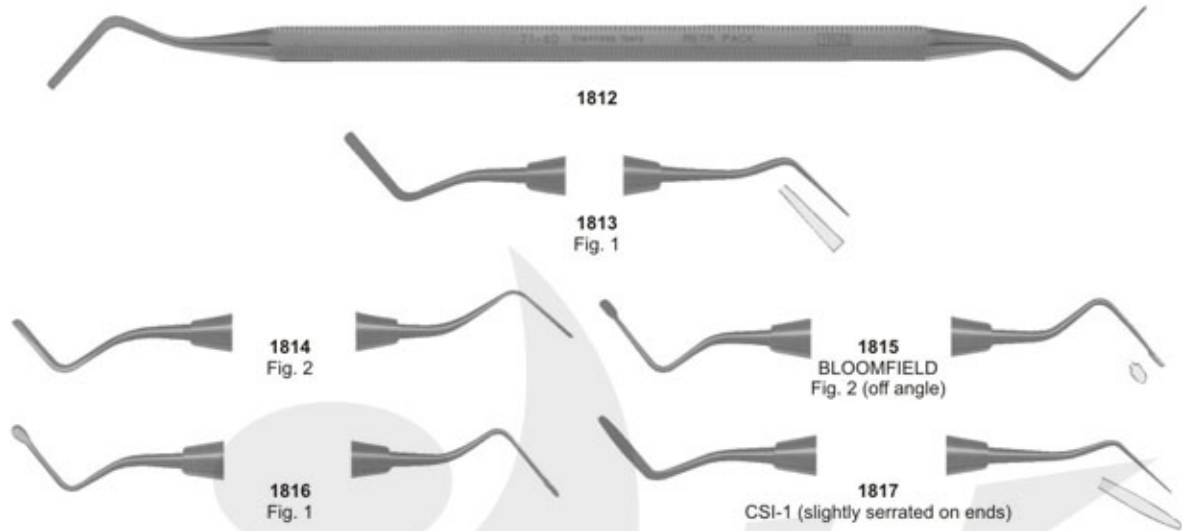

HATCHETS

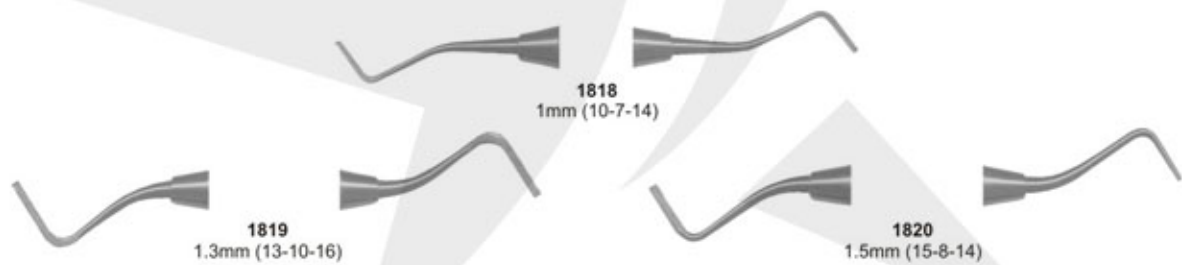

HOES

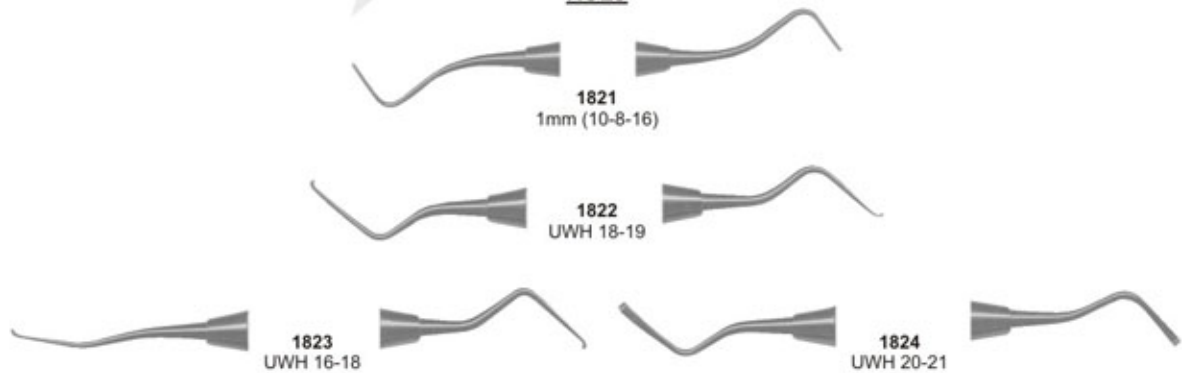



P.K.Thomas waxing & Gracey Curettes Set



1825
P.K.Thomas 1

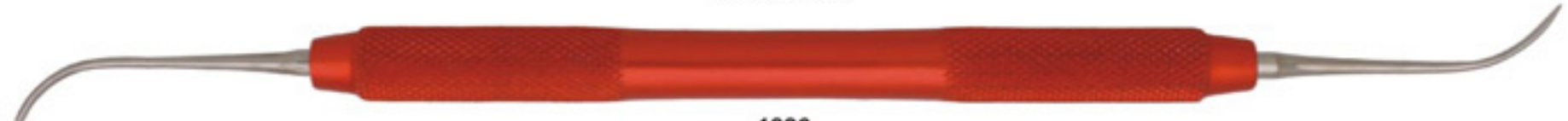

1826
P.K.Thomas 2



1827
P.K.Thomas 3



1828
P.K.Thomas 4

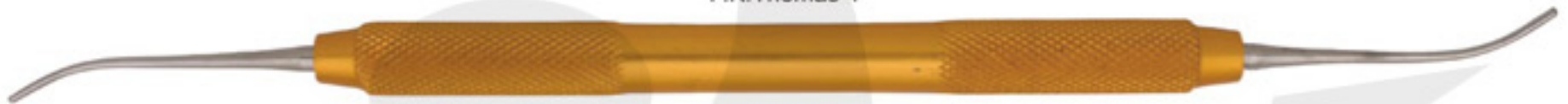

1829
P.K.Thomas 5



7001
Gracey Curettes Set of 7 Pcs, Silicon Handle - Reuseable



Amalgam Pluggers / Condensers / Applicators

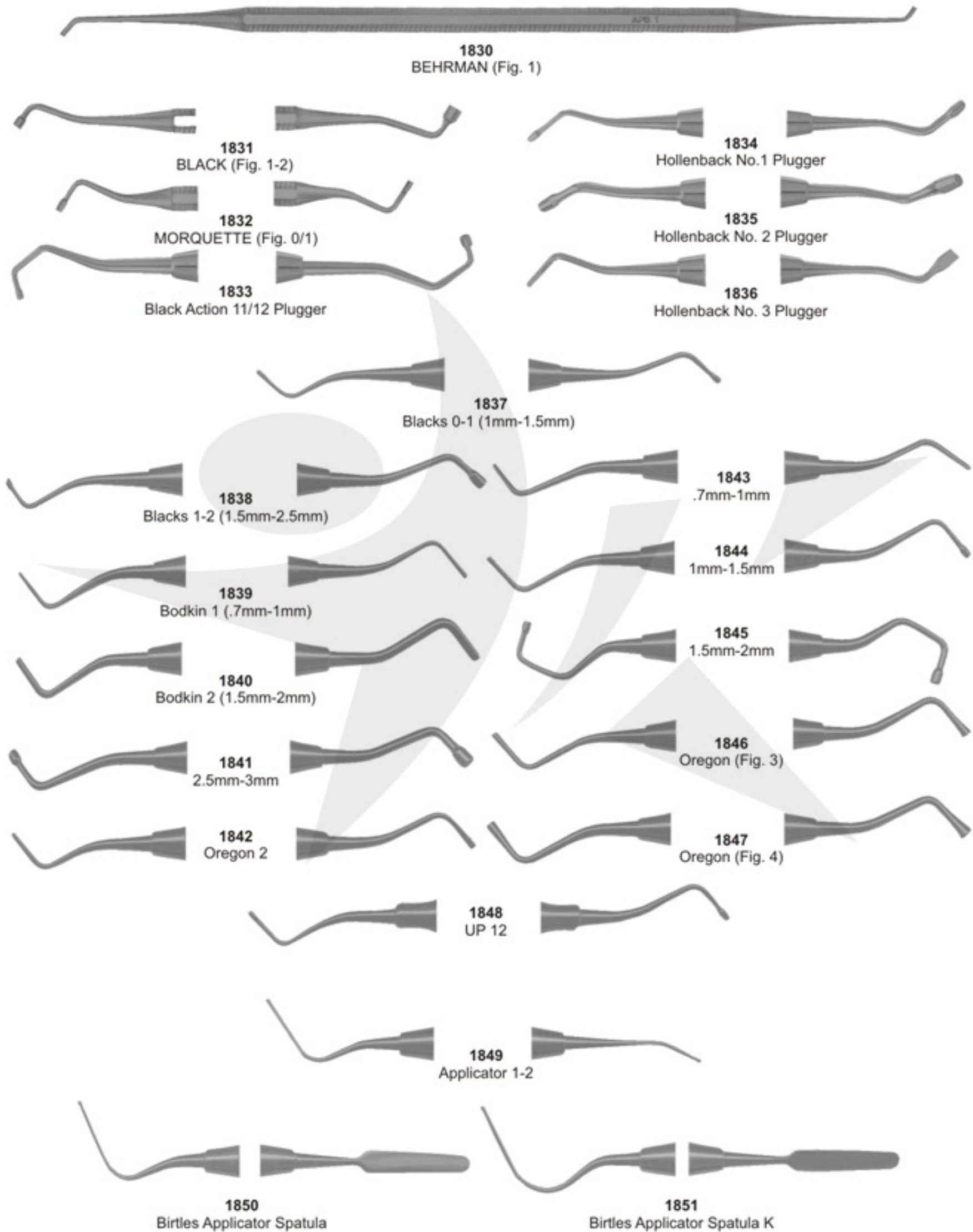



Placement Instruments, Stopping Stoppers, Pluggers

Placement Instruments



1852
PICH (Calcium Hydroxide Placer)



1853
CA

Stopping Stoppers



1854
Woodson 2

Ø 1.6 mm

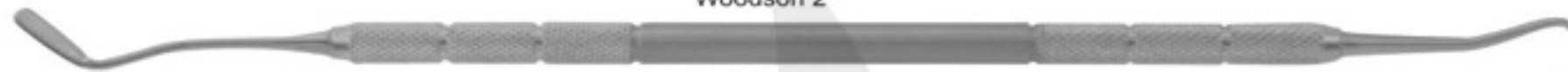

1855
Woodson 3S

Ø 2.4 mm



1856
Woodson 3A

Ø 2.6 mm



1857
Woodson 3

Ø 3.0 mm

Pluggers



Ø 0.75 mm

1858
Pluggers 0-1

Ø 1.2 mm

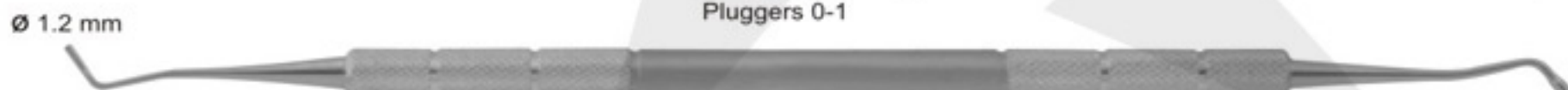

Ø 1.2 mm

1859
Pluggers 1-4

Ø 1.6 mm

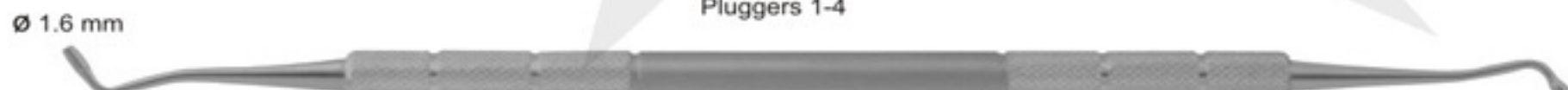

Ø 1.6 mm

1860
Pluggers 4-6

Ø 2.0 mm

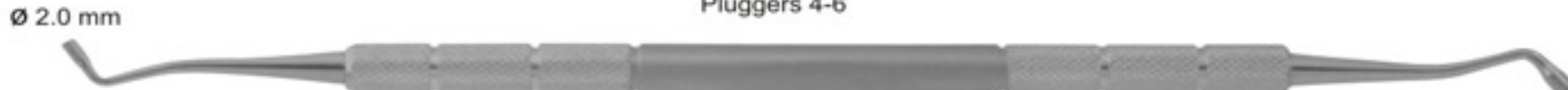

Ø 2.0 mm

1861
Pluggers 6-8

Ø 2.5 mm

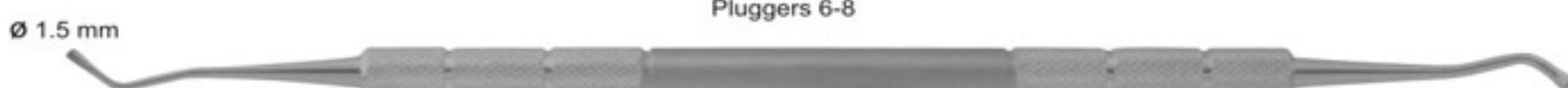

Ø 1.5 mm

1862
Black 1-2

Ø 2.6 mm

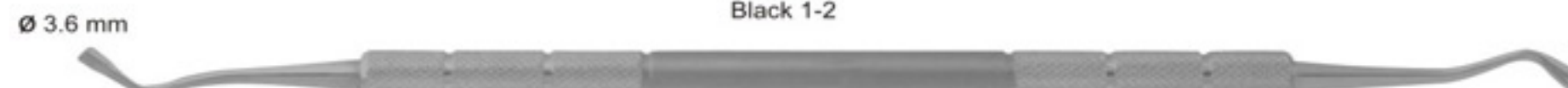

Ø 3.6 mm

1863
Black 2-3

Ø 5.0 mm



Burnishers

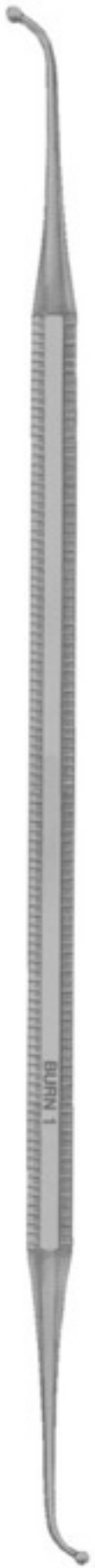

1864
Fig. 1



1865
Fig. 28/29

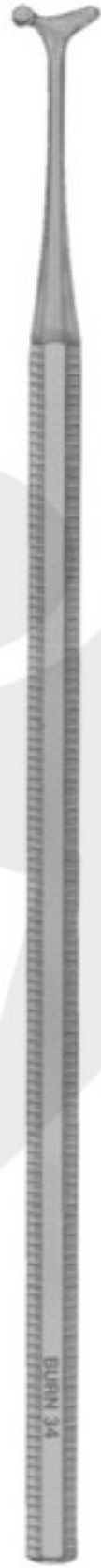

1866
Fig. 34



1867
Fig. 27/29

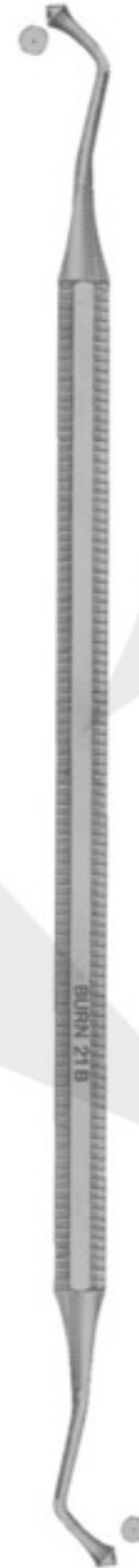

1868
Fig. 21B

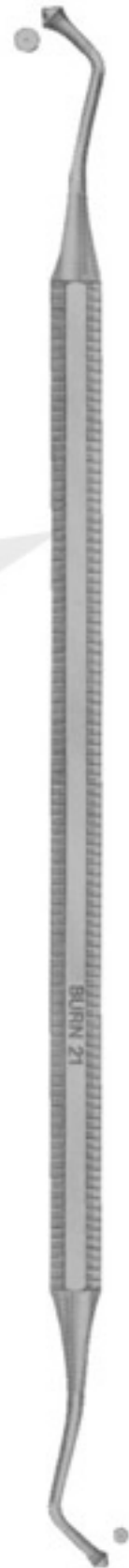

1869
ACORN
Fig. 21



Burnishers

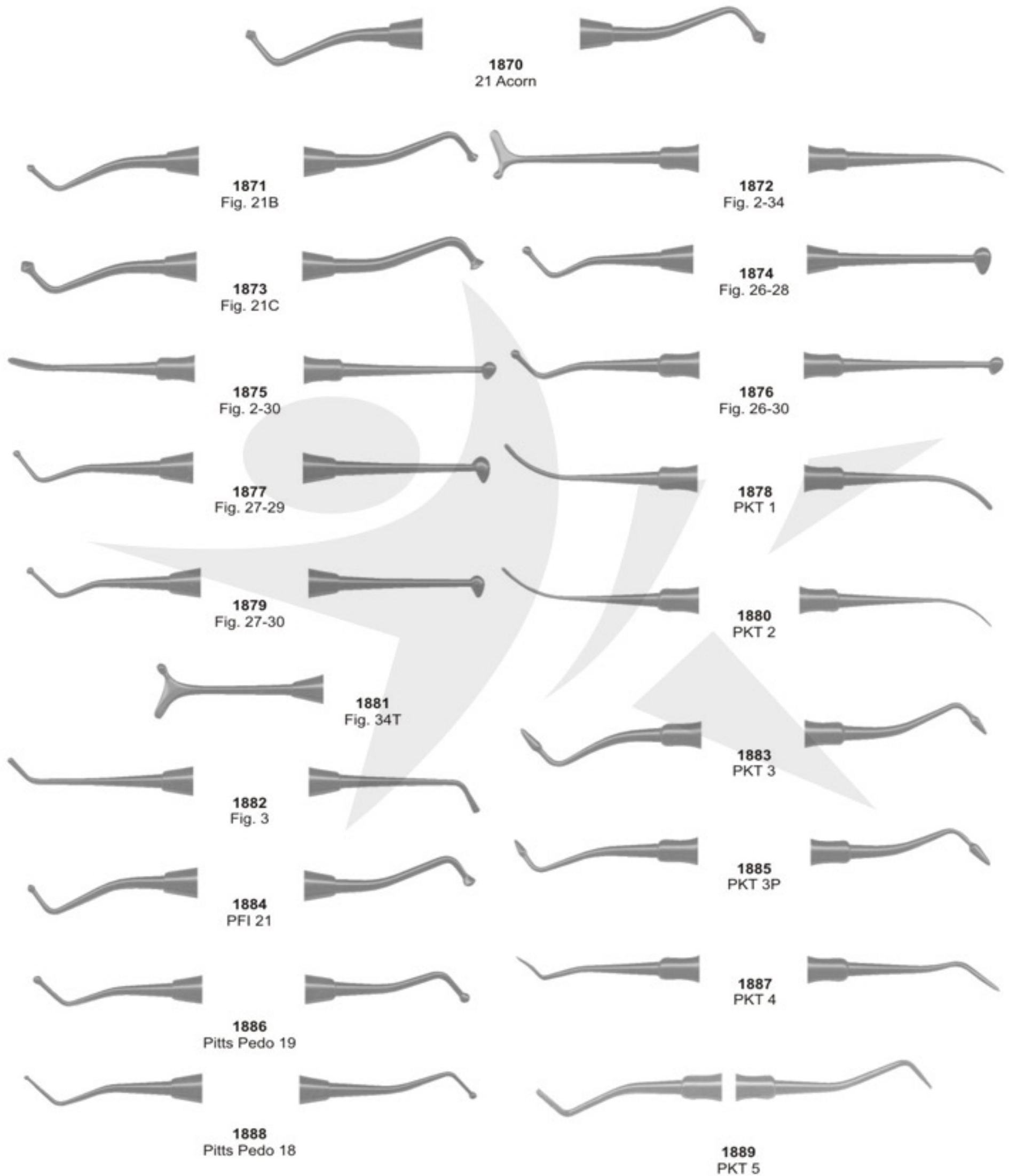



Wax Carvers

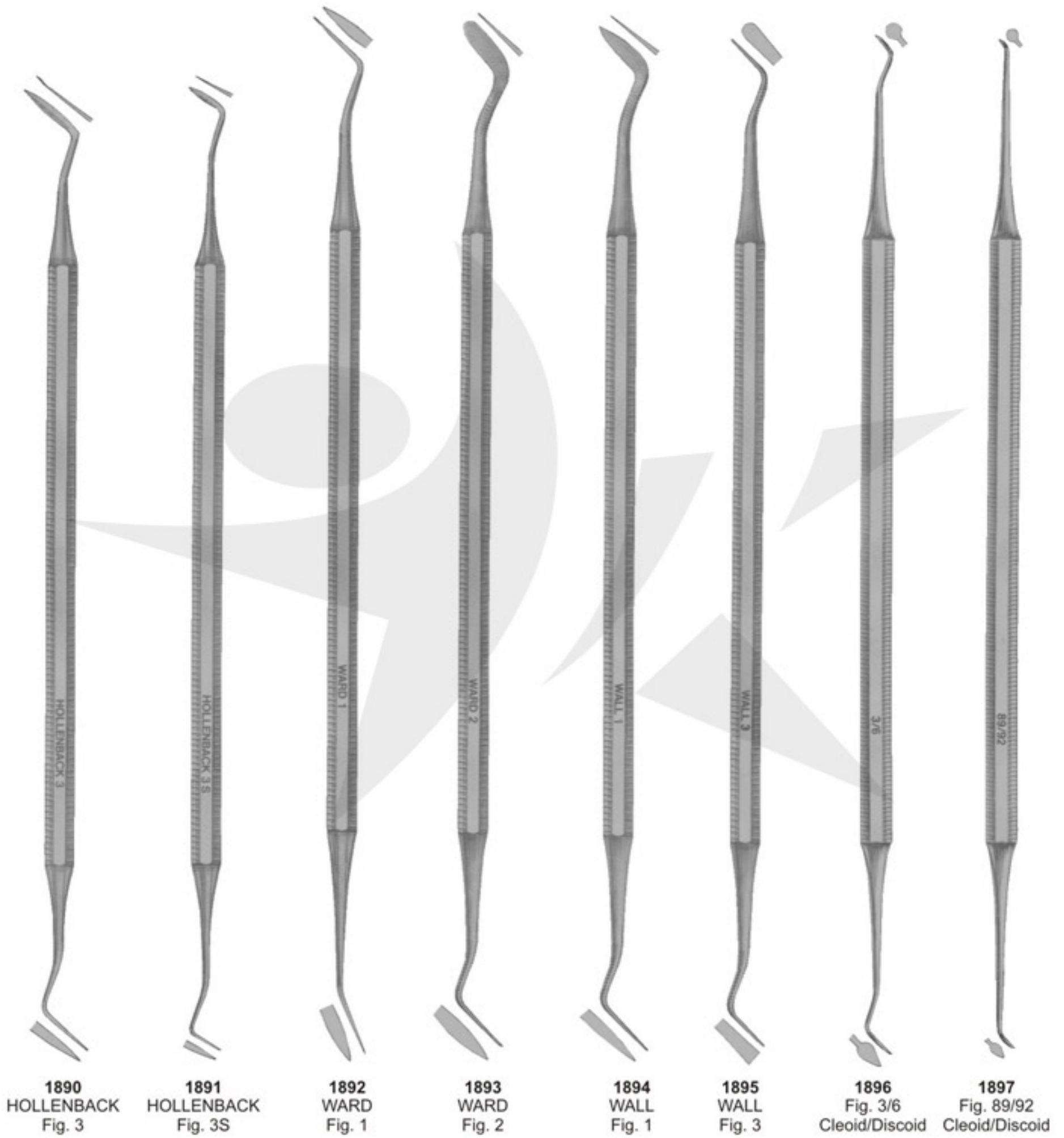



Carvers

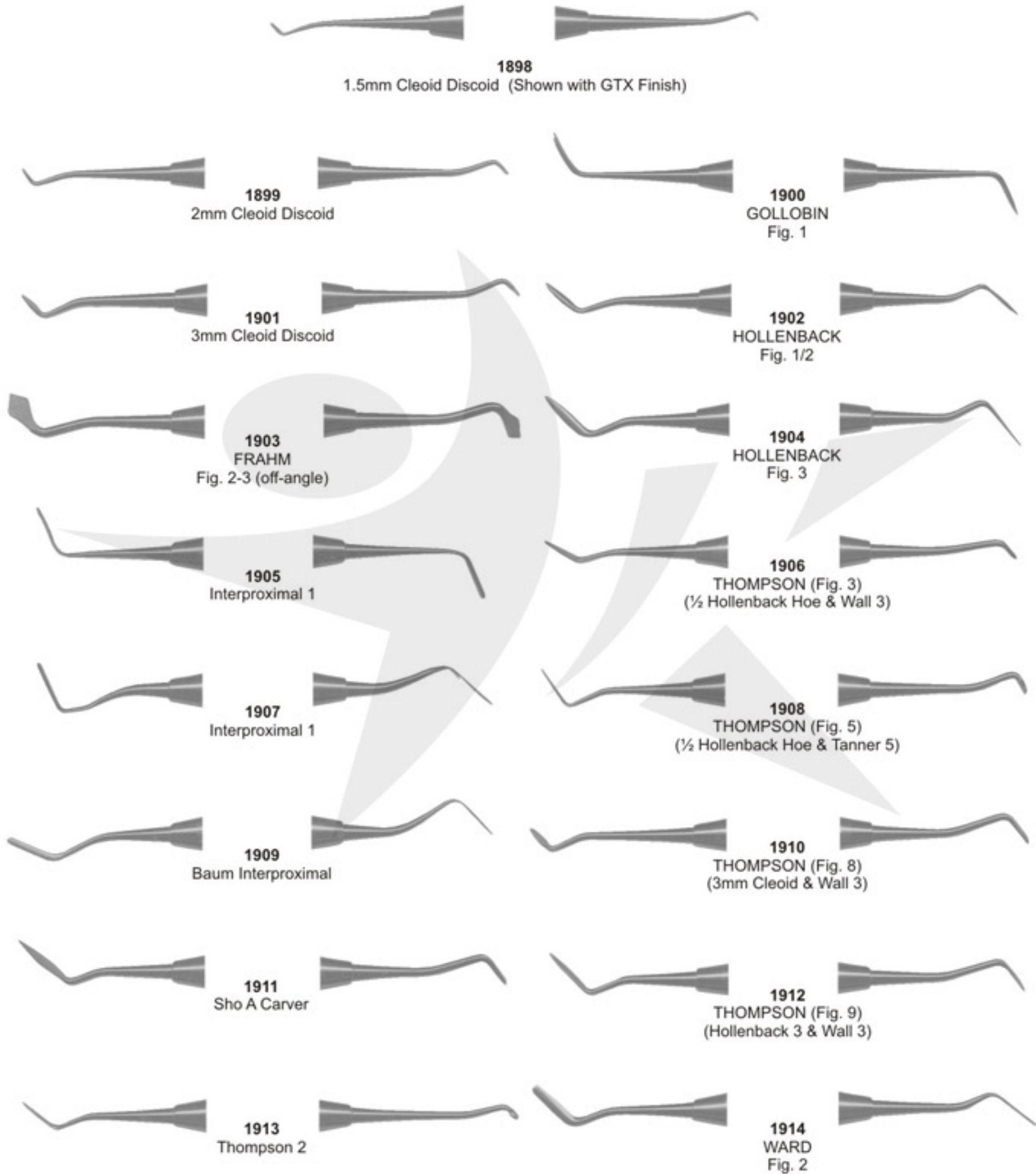



Carvers, Chisels

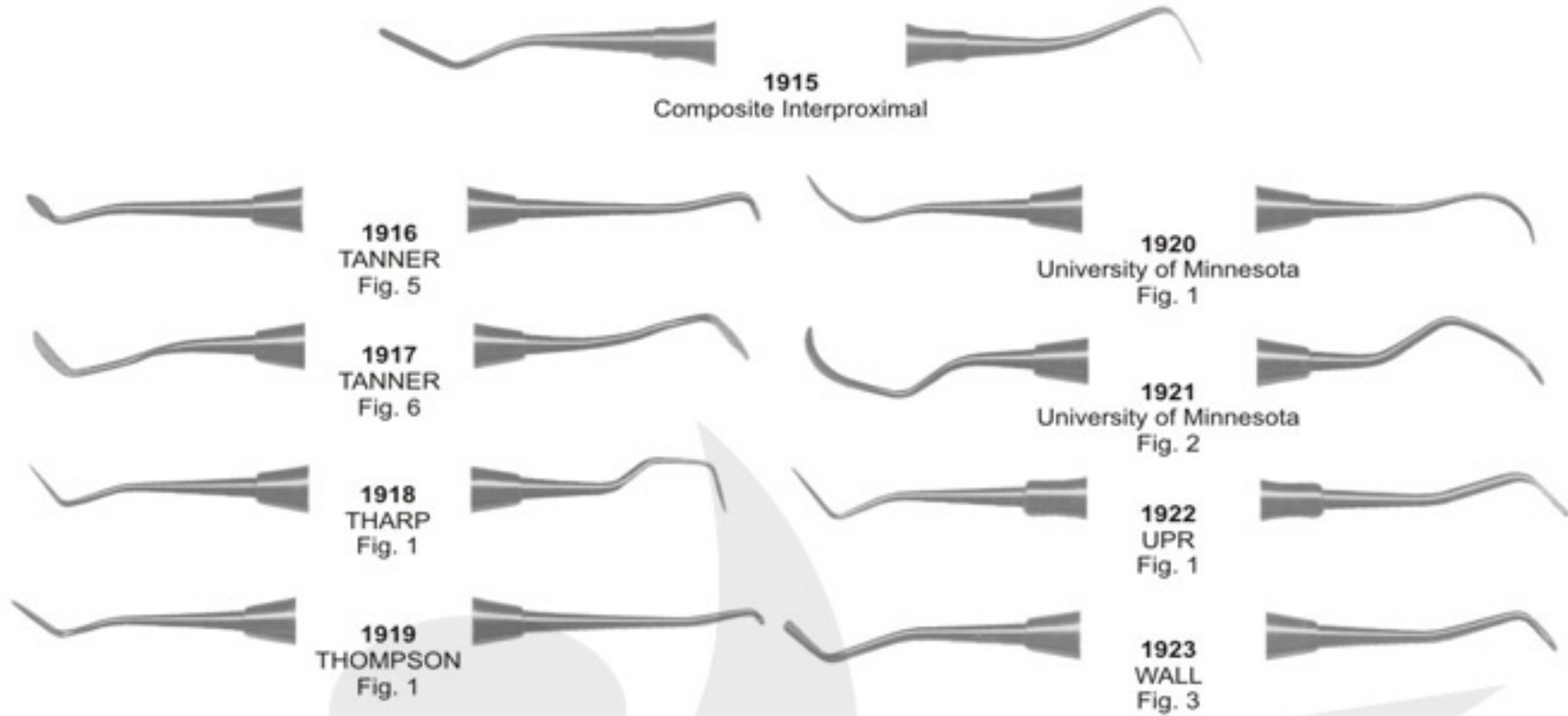

Contour Carbide Carvers - Finishing

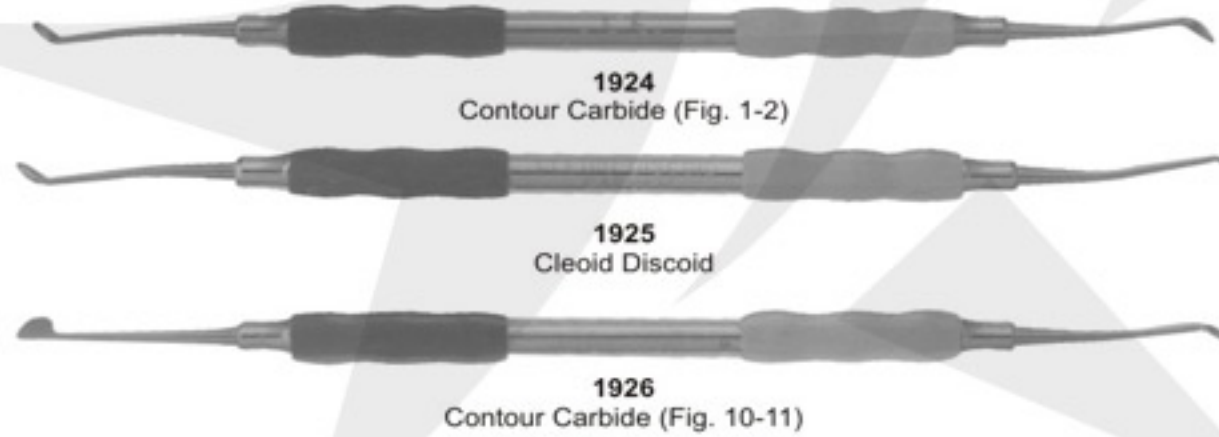

Chisels

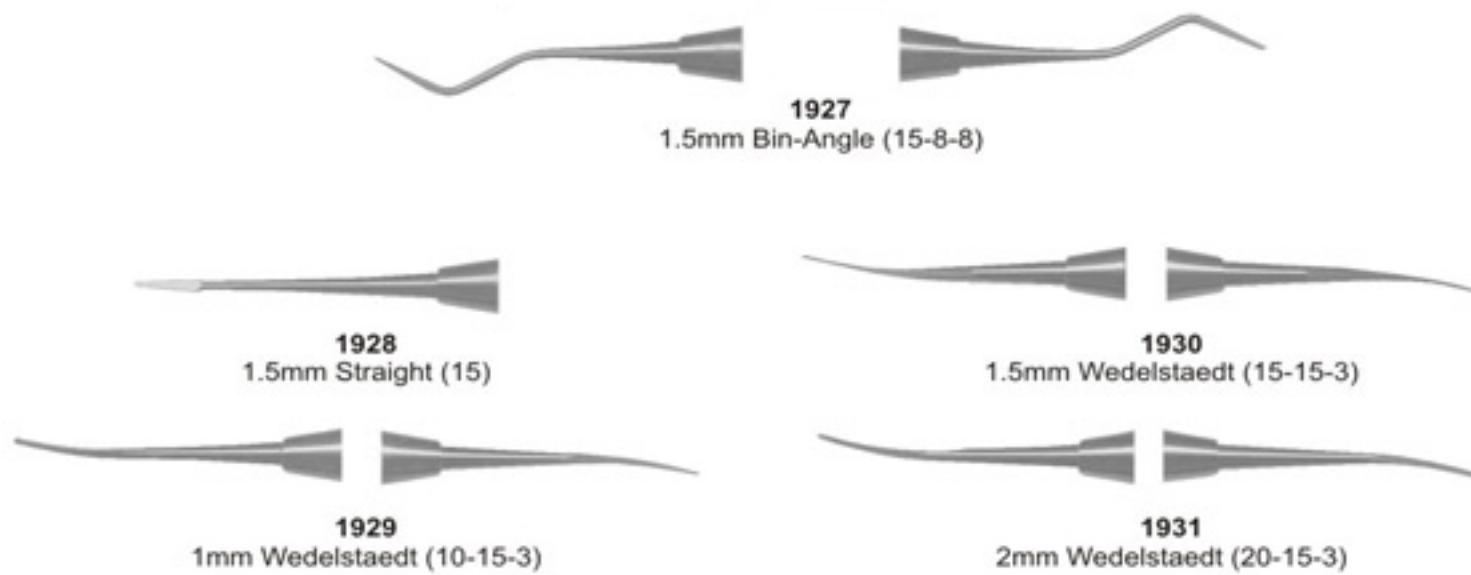



Composite Placement

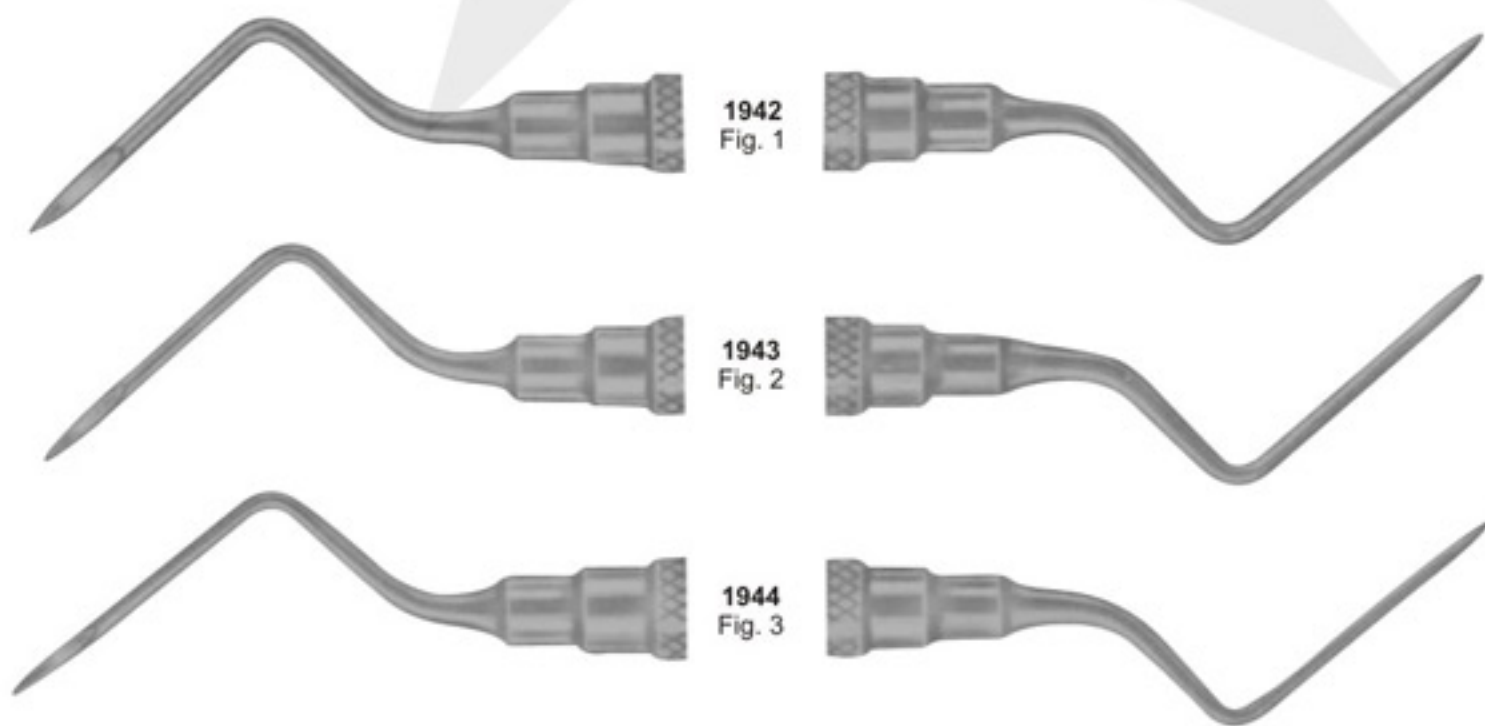
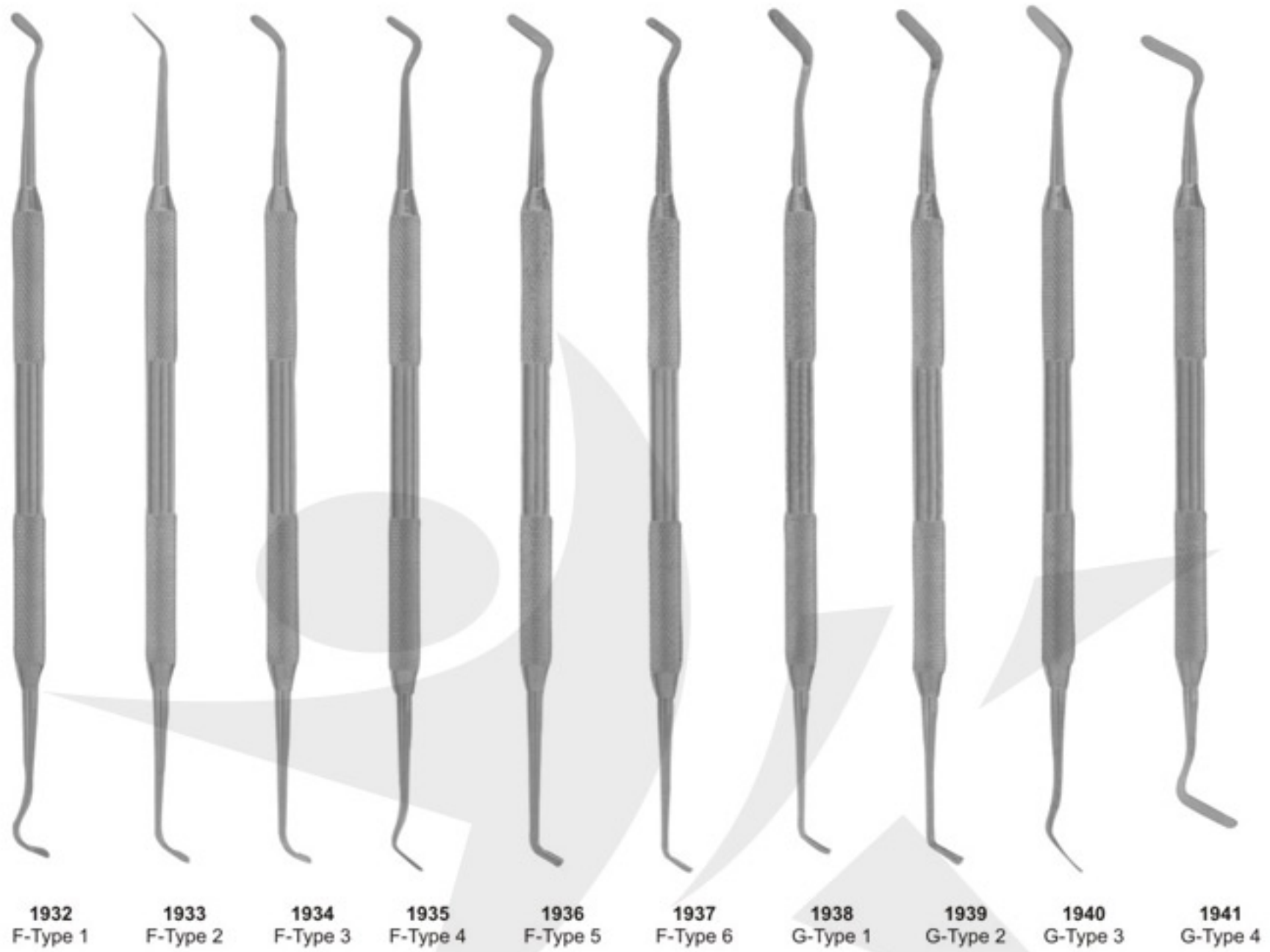



Composite Placement

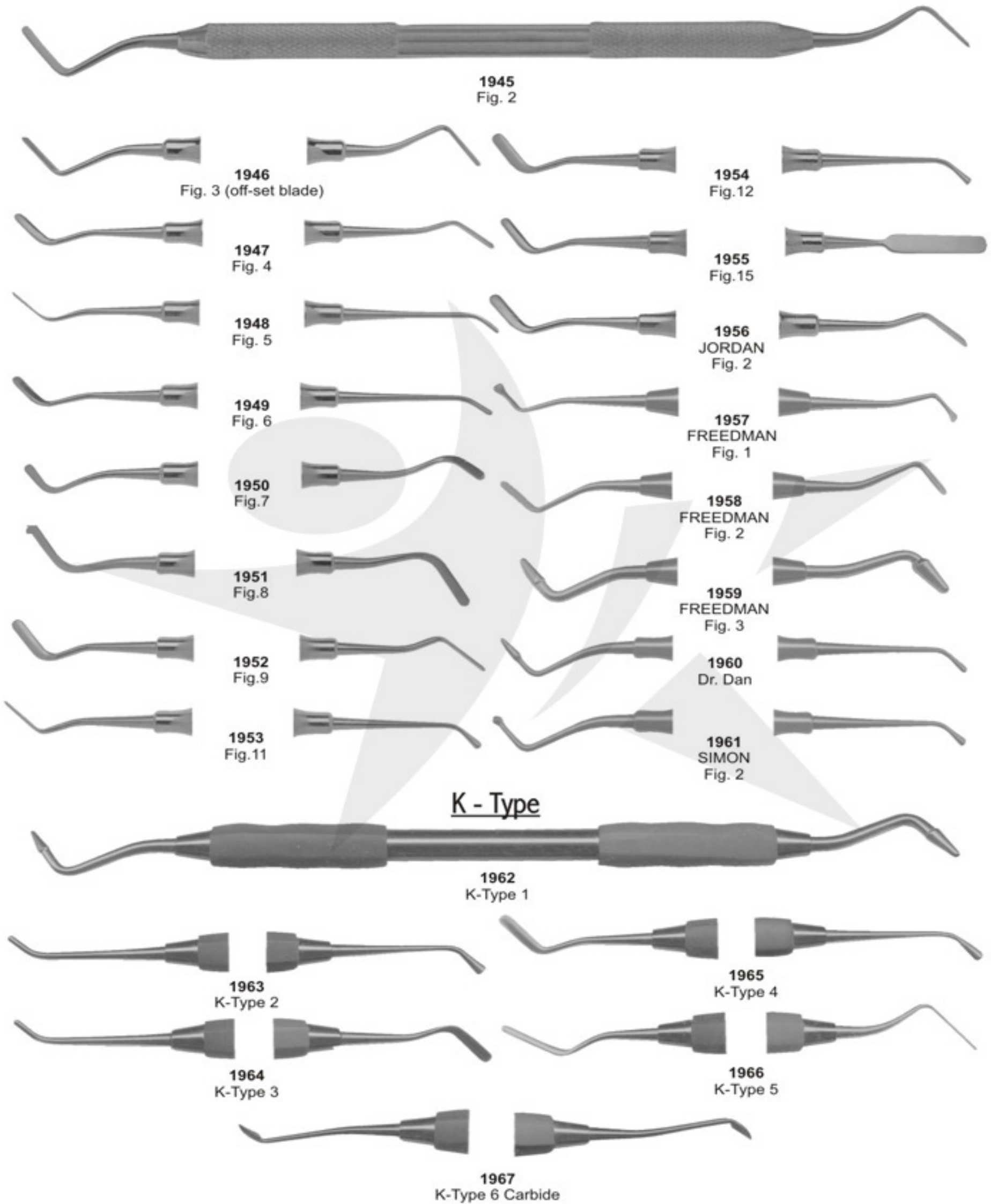



Plastic Filling Instruments

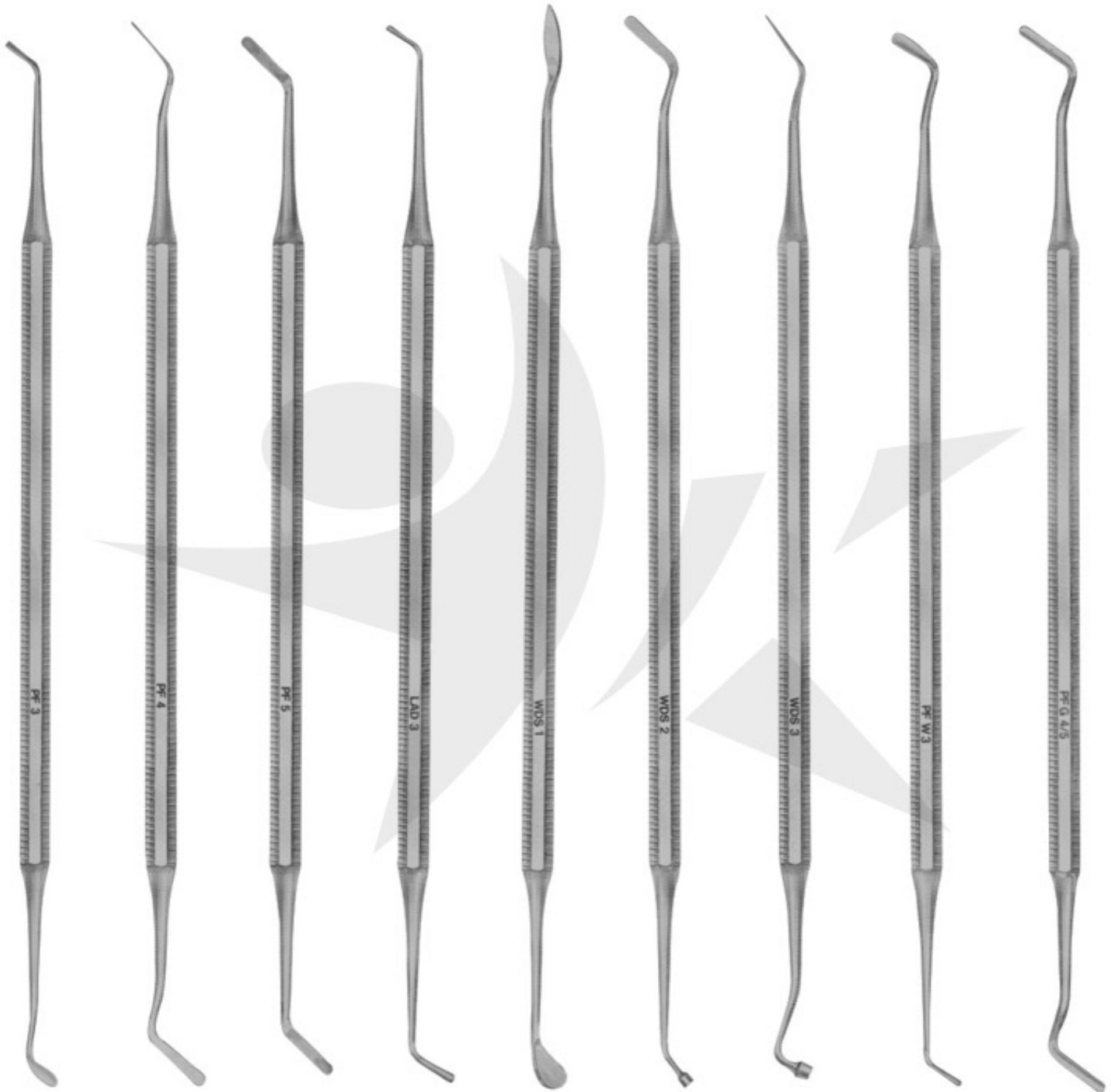

1968
No.3

1969
No.4

1970
No.5

1971
LADMORE
Fig. 3

1972
WOODSON
Fig. 1

1973
WOODSON
Fig. 2

1974
WOODSON
Fig. 3

1975
W-3

1976
Gregg
4/5



Plastic Filling Instruments



1977
Fig. 5-7



1978
Fig.1



1979
Fig. 3



1983
GLICK
Fig.1



1980
Fig. 4



1984
P8



1981
Fig. 5-7



1985
WOODSON
Fig. 1

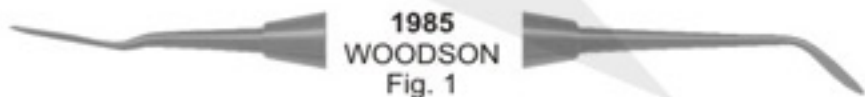

1982
Fig. 8A



1986
WOODSON
Fig. 2



1987
WOODSON
Fig. 3





Curettes

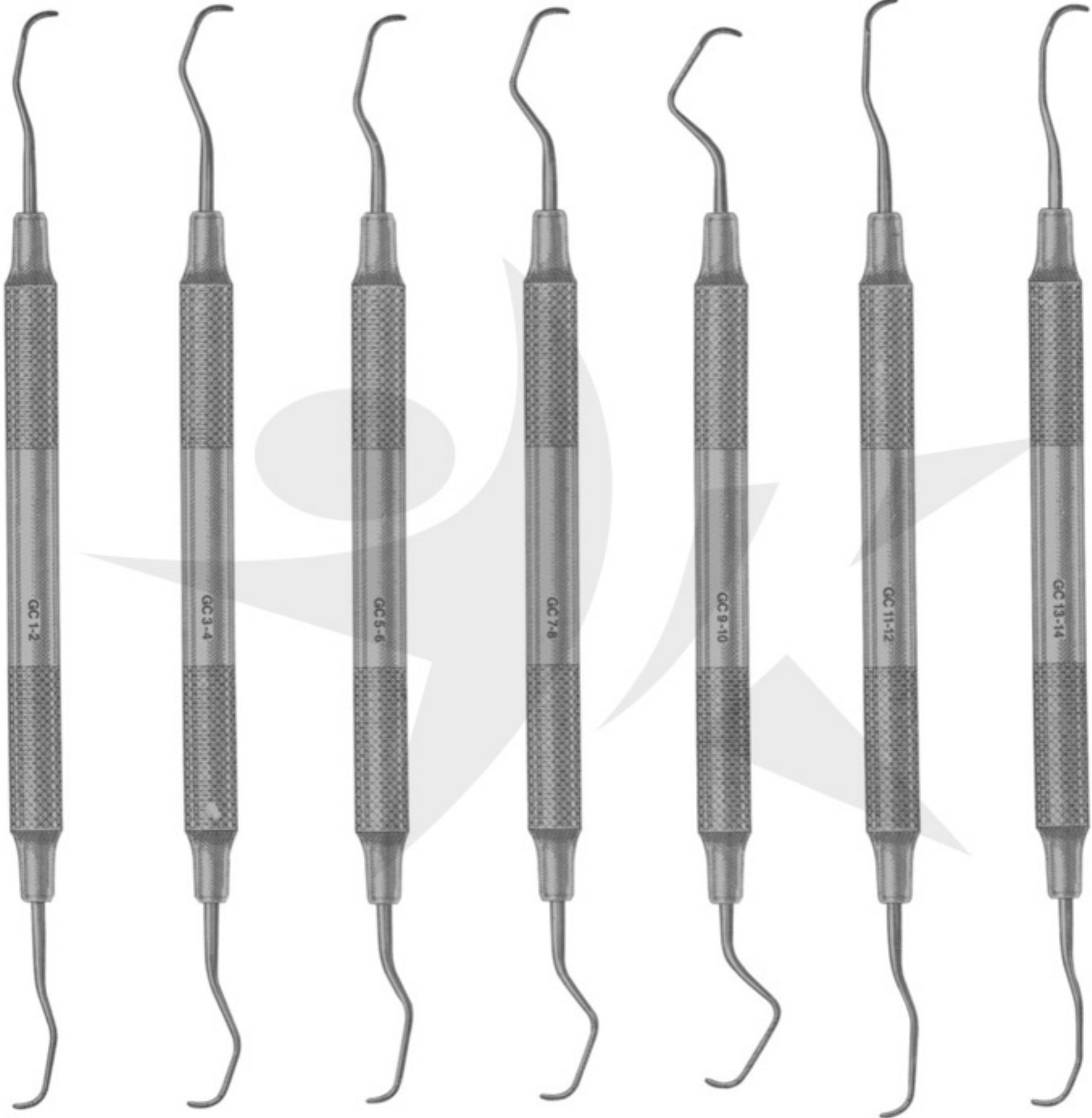

1988
GRACEY
GC 1-2

1989
GRACEY
GC 3-4

1990
GRACEY
GC 5-6

1991
GRACEY
GC 7-8

1992
GRACEY
GC 9-10

1993
GRACEY
GC 11-12

1994
GRACEY
GC 13-14



Gracey Currettes



1995
G1-2



1996
G3-4



1997
G5-6



1998
G7-8

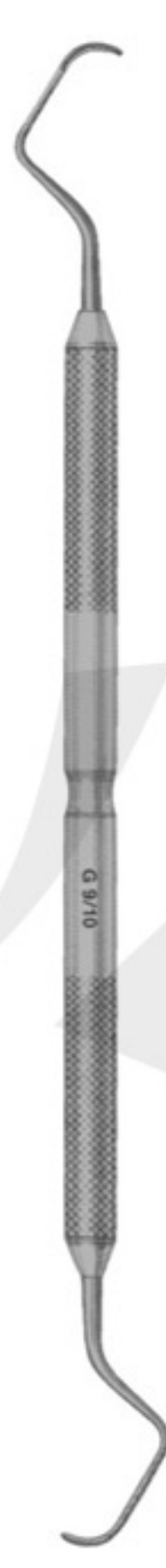

1999
G9-10



2000
G11-12



2001
G13-14



Curettes # 4 Handle

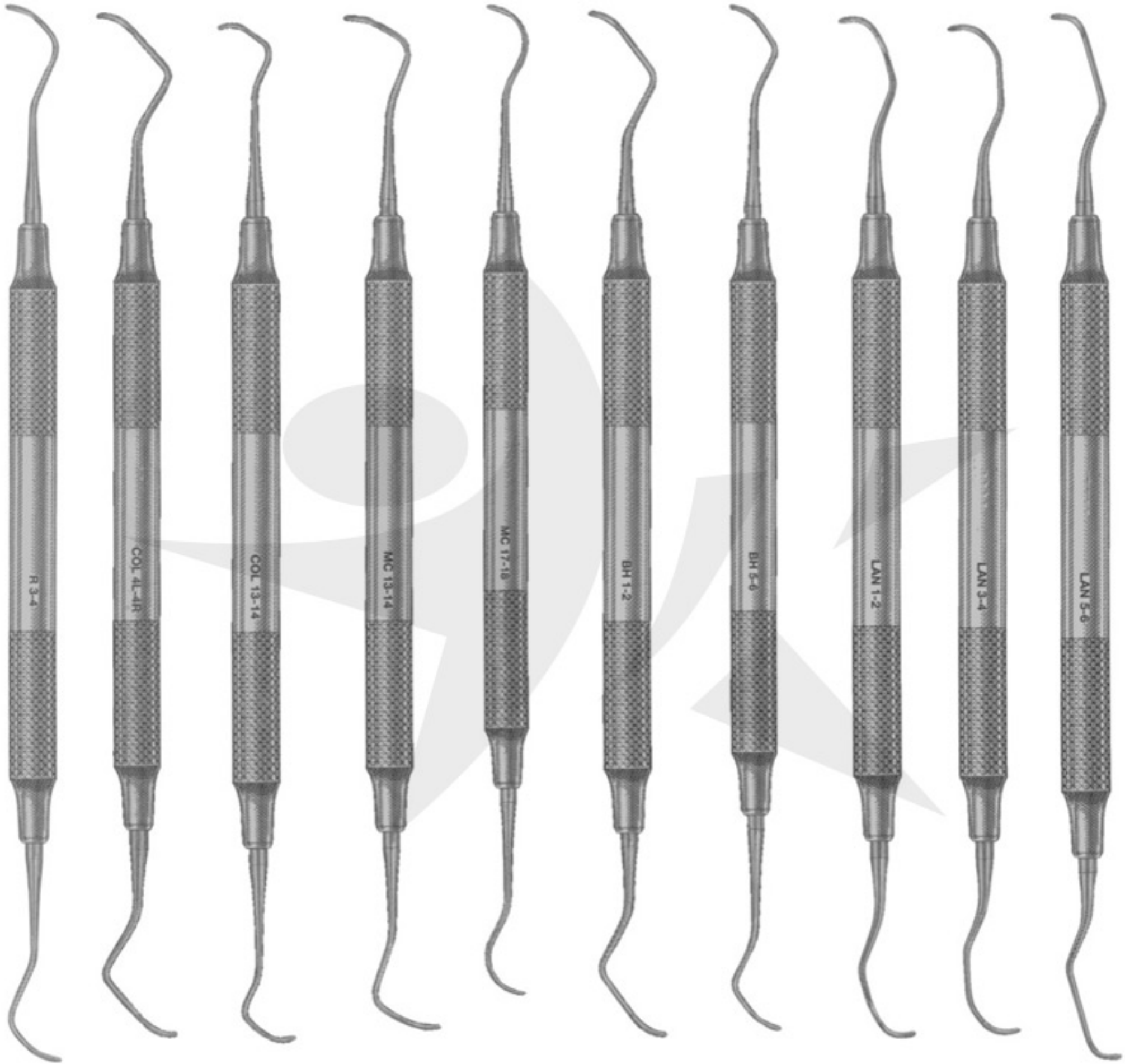

2002 RULE 3-4	2003 COLUMBIA 4R-4L	2004 COLUMBIA 13-14	2005 MCCALLS 13-14	2006 MCCALLS 17-18	2007 BARNHART 1-2	2008 BARNHART 5-6	2009 LANGER 1-2	2010 LANGER 3-4	2011 LANGER 5-6
----------------------------	----------------------------------	----------------------------------	---------------------------------	---------------------------------	--------------------------------	--------------------------------	------------------------------	------------------------------	------------------------------



Curettes

COLUMBIA CURETTES



2012
4L-4R

2013
13-14

2014
2L-2R

MCCALLS CURETTES



2015
13-14

2016
13S-14S

2017
17-18

2018
17S-18S



Curettes

GOLDMAN FOX



2019
GF1 Universal Scaler



2020
GF2 Curette



2021
GF3 Curette



2022
GF4 Curette



2023
GF5 Hoe



2024
GF6 Hoe



Curettes

GOLDMAN FOX



2025
GF 7 Knife



2026
GF 8 Spear Knife



2027
GF 9 Knife Scaler



2028
GF 11 Spear Knife



2029
GF 21 Sharp Spoon /
Small Scaler



Knives, Interproximal Files



2030
Kirkland 15 / 16

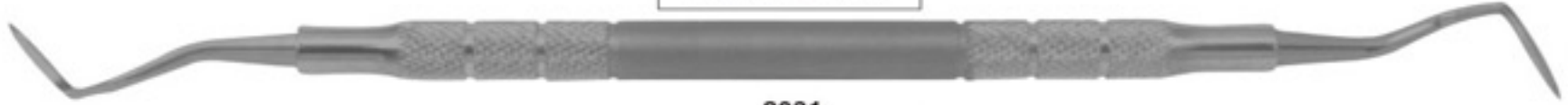

2031
Ordan 1 / 2



2032
Buck 3 / 4

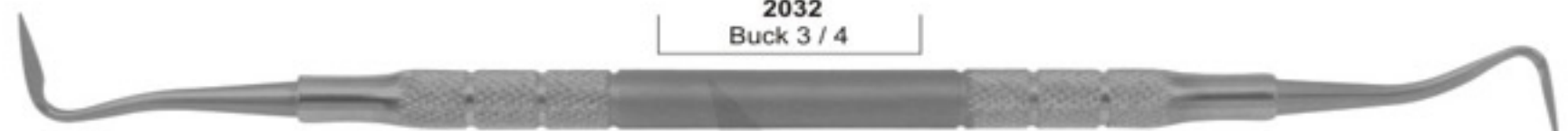

2033
Buck 5 / 6



2034
Goldman-Fox 7

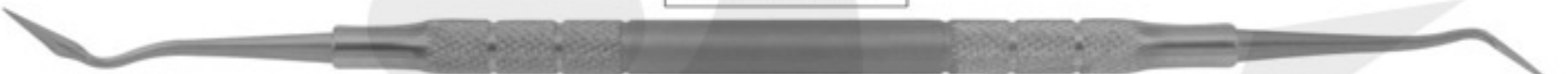

2035
Goldman-Fox 8



2036
Goldman-Fox 9

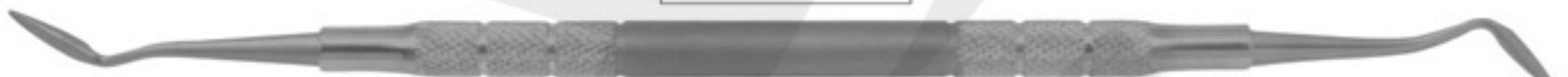

2037
Goldman-Fox 11



2038
CK 3 (Crane)

Interproximal Files



2039
Sugarman 1S-2S

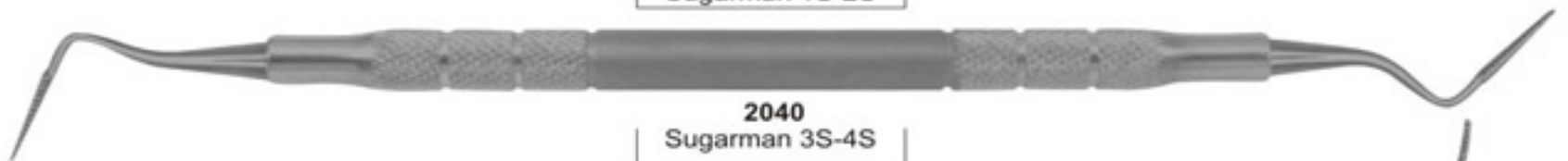

2040
Sugarman 3S-4S

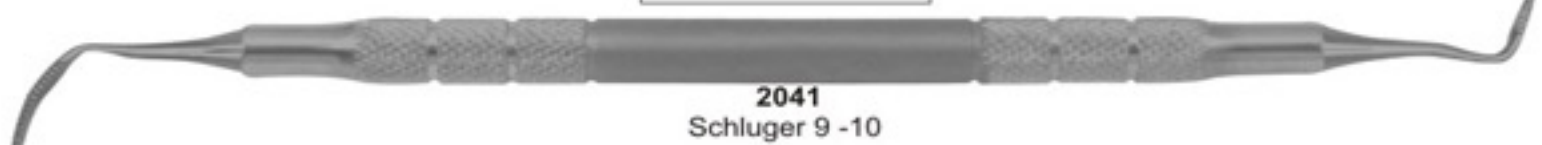

2041
Schluger 9 - 10



2042
Buck 11 - 12



Curettes, Root Planning Curettes



2043
COLUMBIA (2L-2R)



2044
MCCALL (13-14)



2045
MCCALL (17S-18S)

Root Planning Curettes



2046
Root Plane (1-2)



2047
Root Plane (5-6)

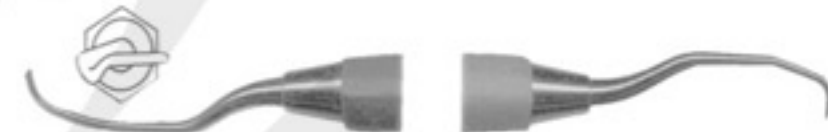

2049
Root Plane (11-12)



2048
Root Plane (7-8)



2050
Root Plane (13-14)



2051
Petite (1-2)



2052
Petite (11-12)



2053
Petite (5-6)



2054
Petite (13-14)



Curettes



2055
BARNHART (1-2)



2056
BARNHART (5-6)

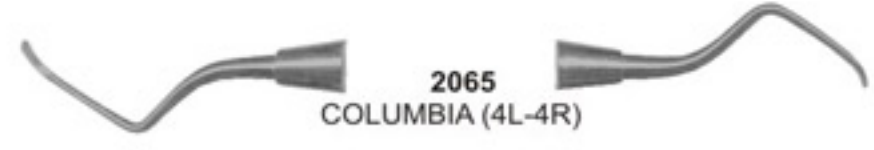

2065
COLUMBIA (4L-4R)

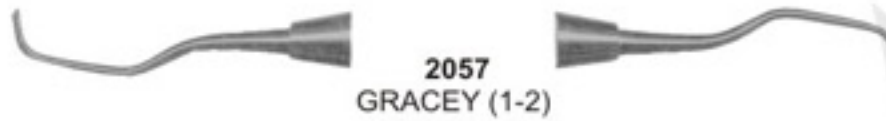

2057
GRACEY (1-2)

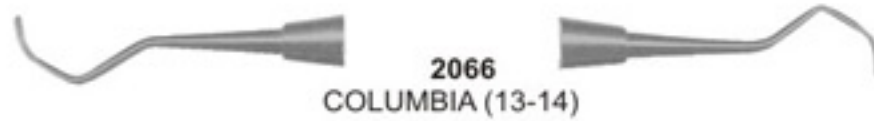

2066
COLUMBIA (13-14)



2058
GRACEY (3-4)



2067
LANGER (1-2)



2059
GRACEY (5-6)



2068
LANGER (3-4)



2060
GRACEY (7-8)



2069
LANGER (5-6)



2061
GRACEY (9-10)



2070
MCCALL (13-14)

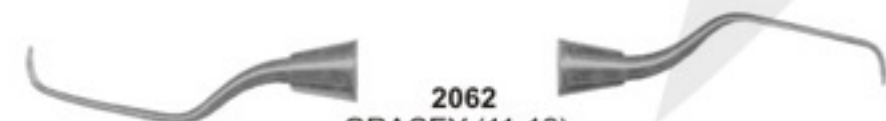

2062
GRACEY (11-12)



2071
MCCALL (13S-14S)

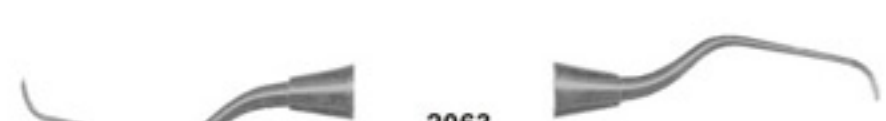

2063
GRACEY (13-14)



2072
MCCALL (17-18)

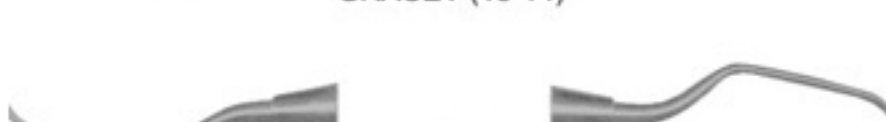

2064
GRACEY (2L-2R)

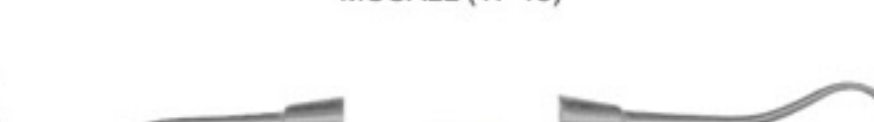

2073
MCCALL (17S-18S)



2074
RULE (3-4)





Dental Products

Silicon Handles-Reusable

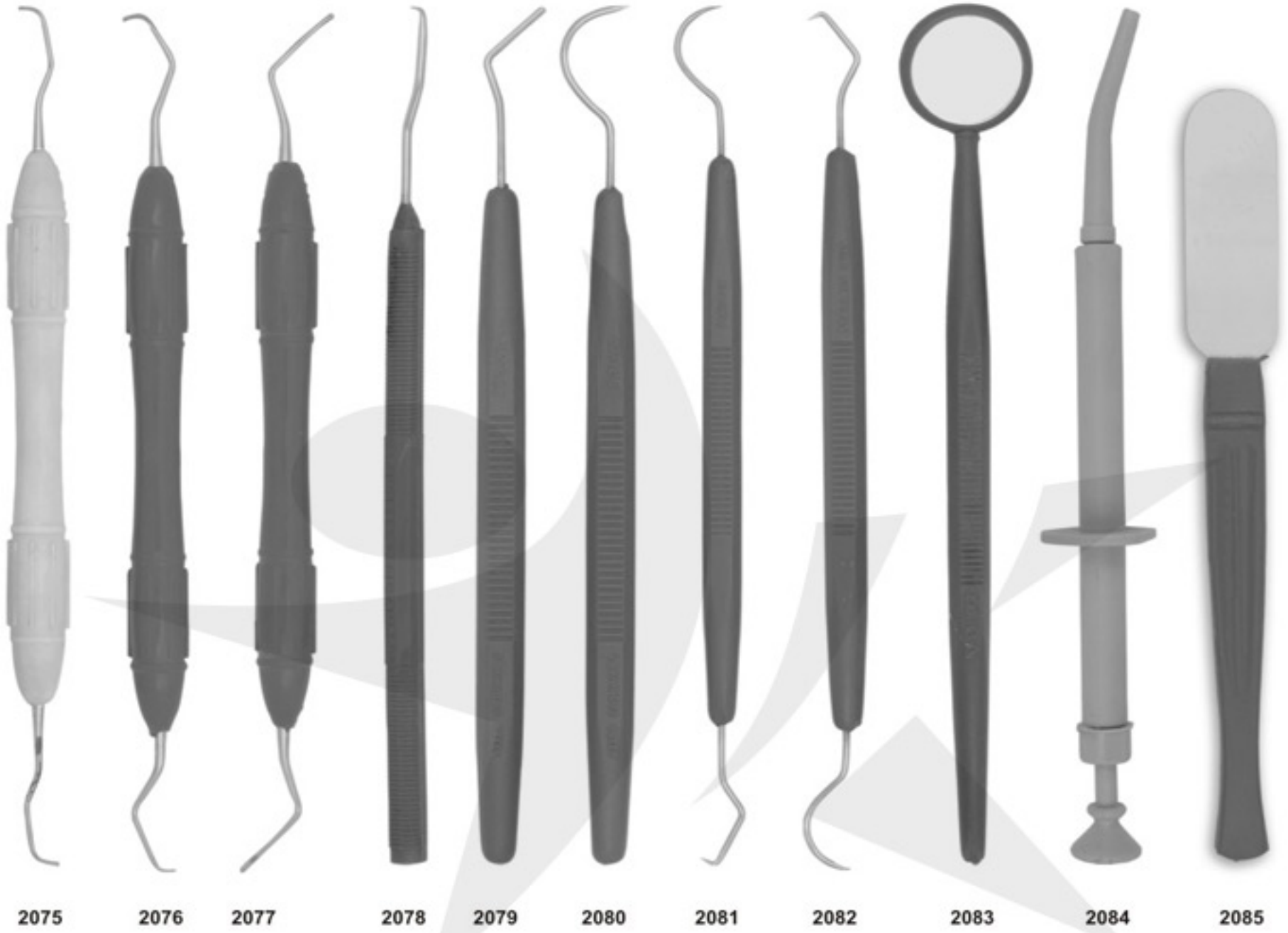



Wax, Porcelain & Cement Instruments

Comfort Grip Vinyl - Covered Insulating Handles

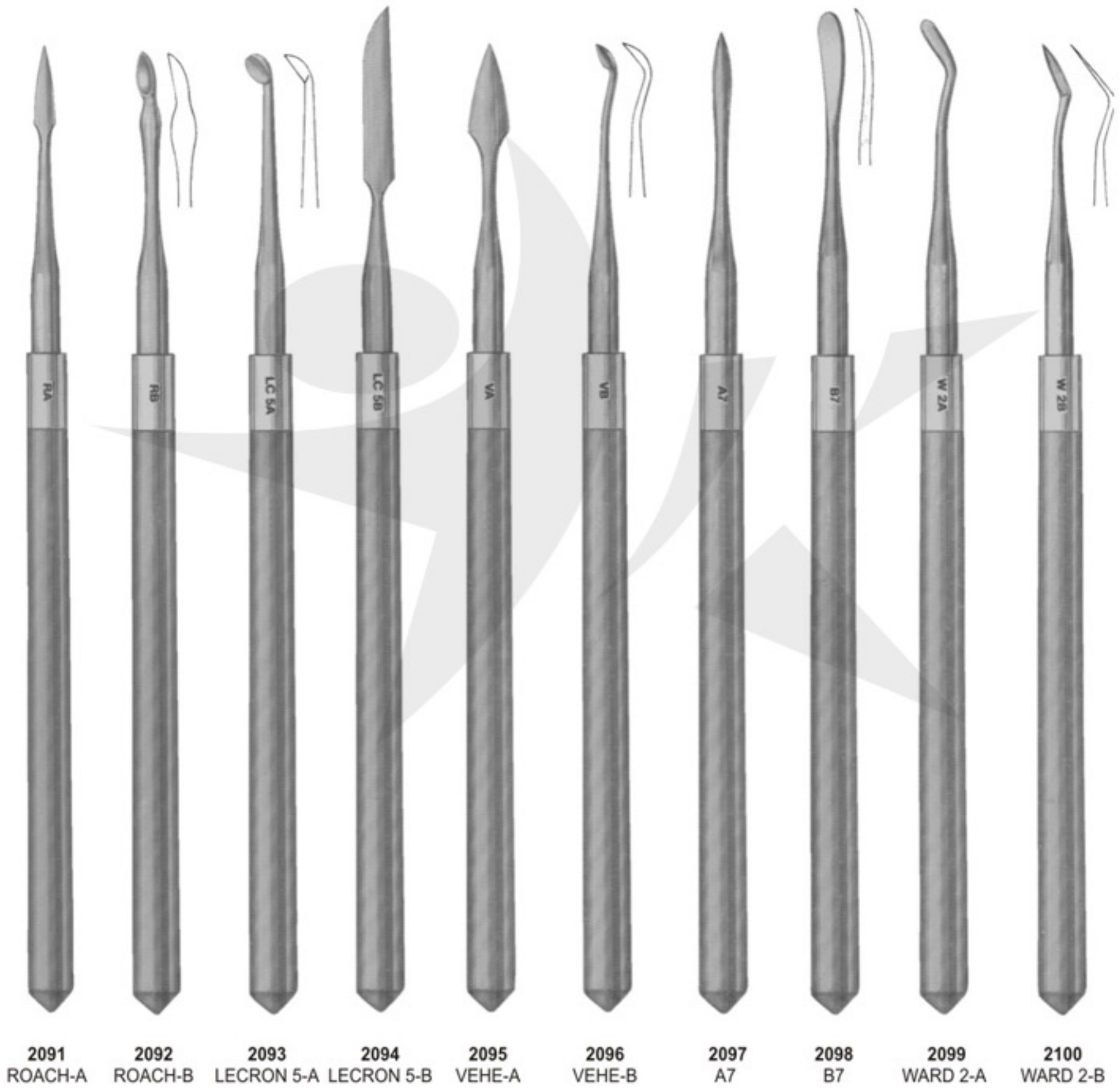



Wax, Porcelain & Cement Instruments

P.K. THOMAS



2101 PKT 1 2102 PKT 2 2103 PKT 3 2104 PKT 4 2105 PKT 5

Set of 5 instruments

WAX CARVERS

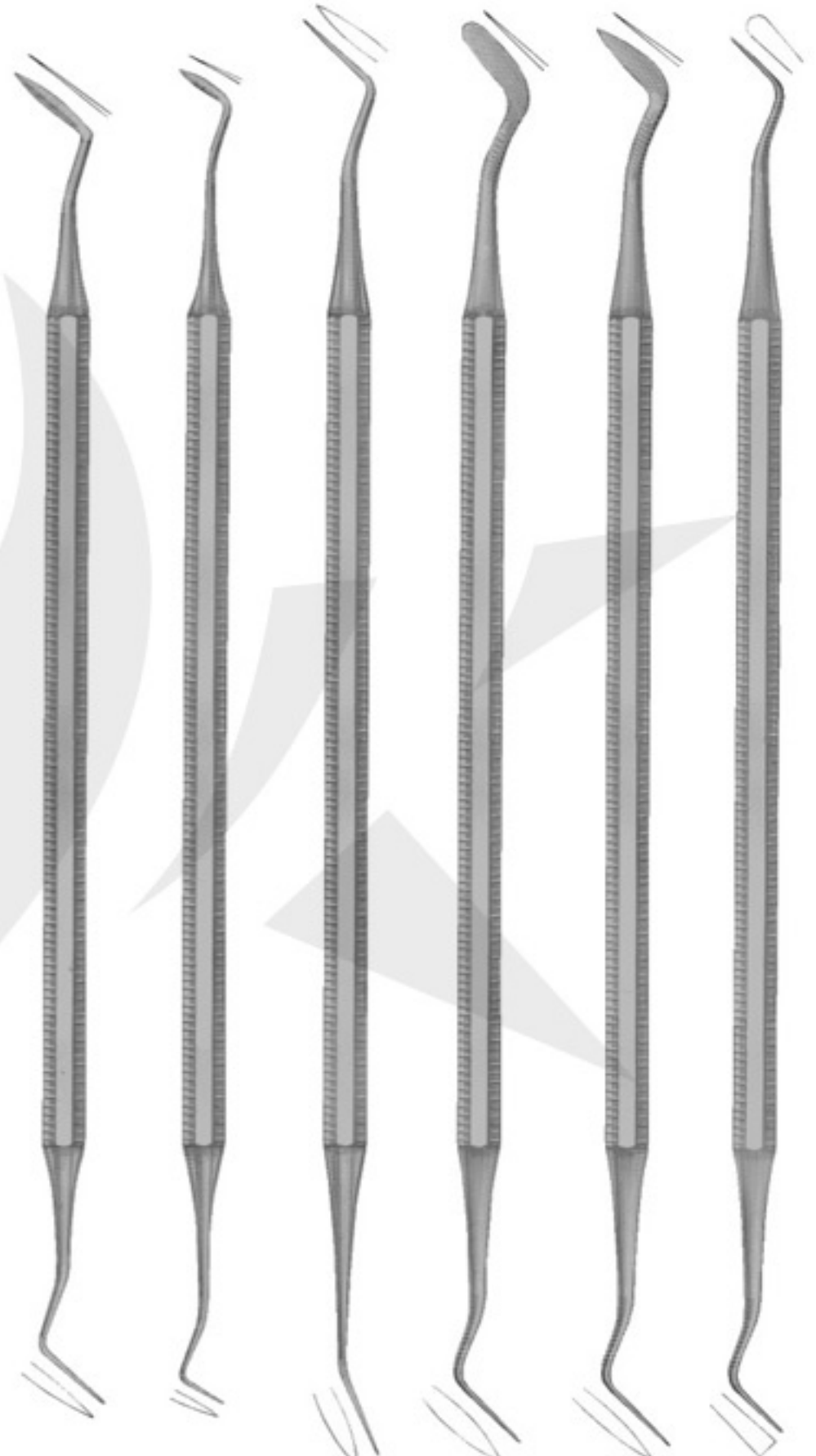

2106 Hollenback 3 2107 Hollenback 3S 2108 WARD 1 2109 WARD 2 2110 WALL 1 2111 WALL 3



Wax & Modeling Carvers, Cement Spatulas

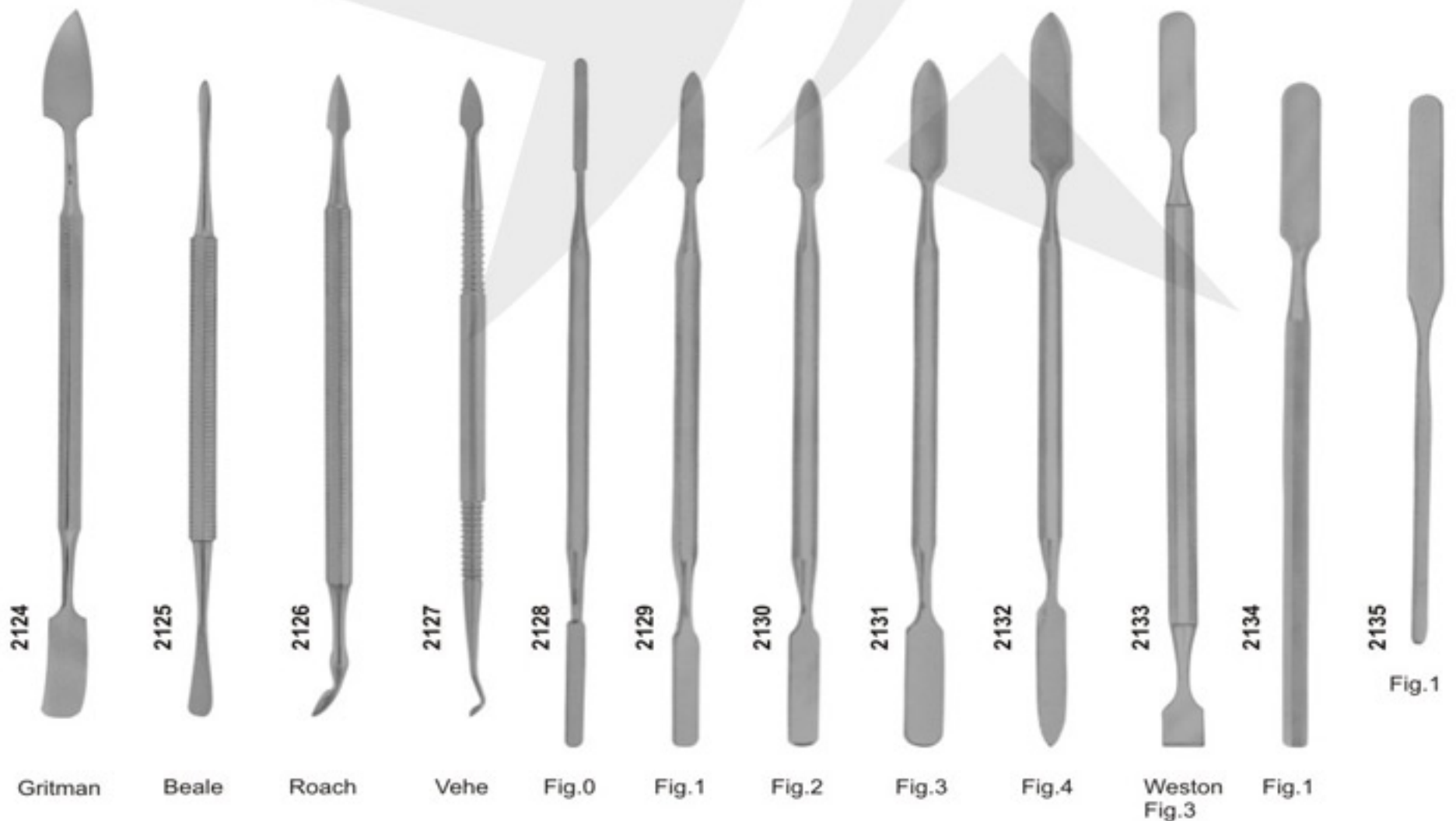
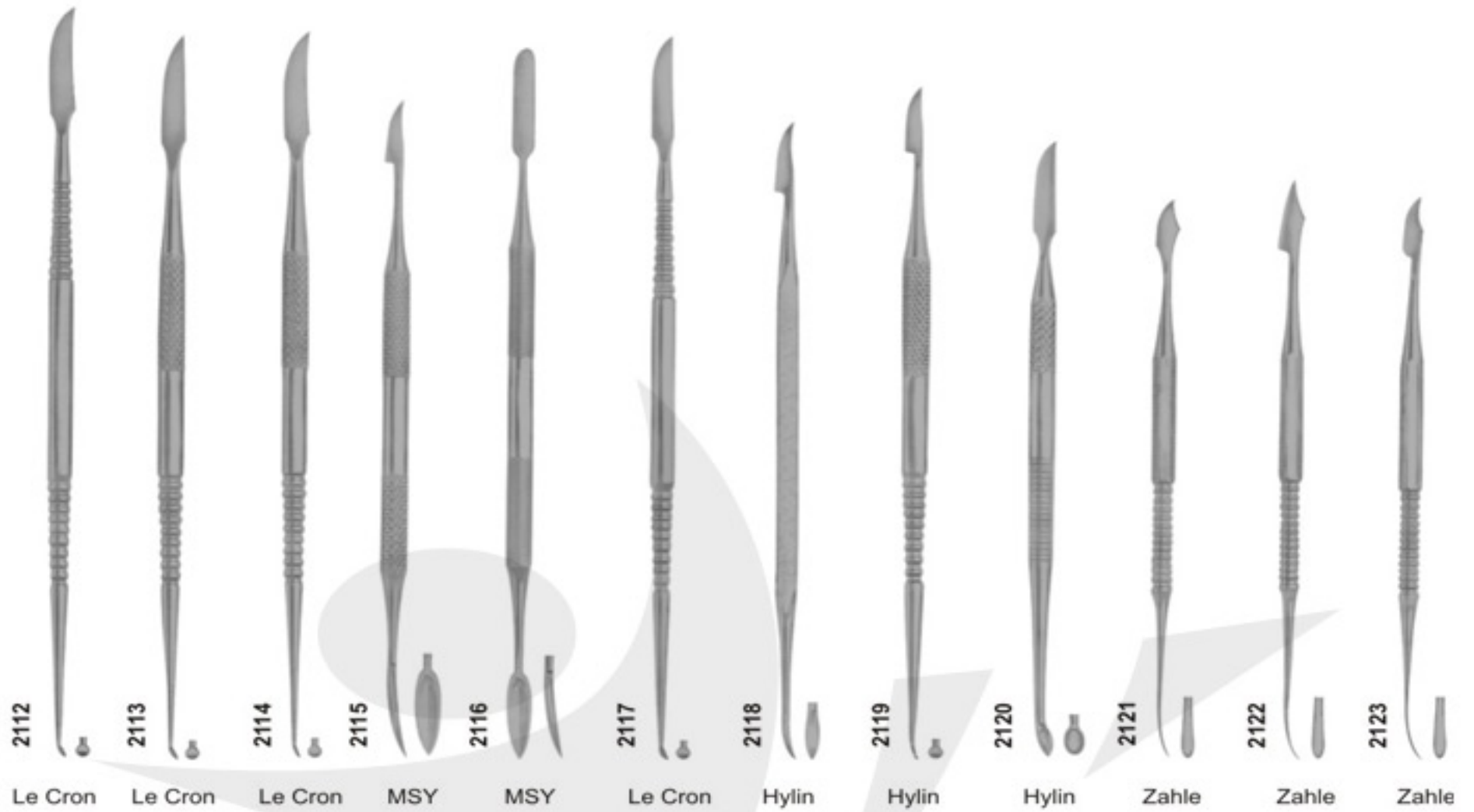



Wax, Porcelain & Cement Instruments

WAX & PORCELAINE CARVERS

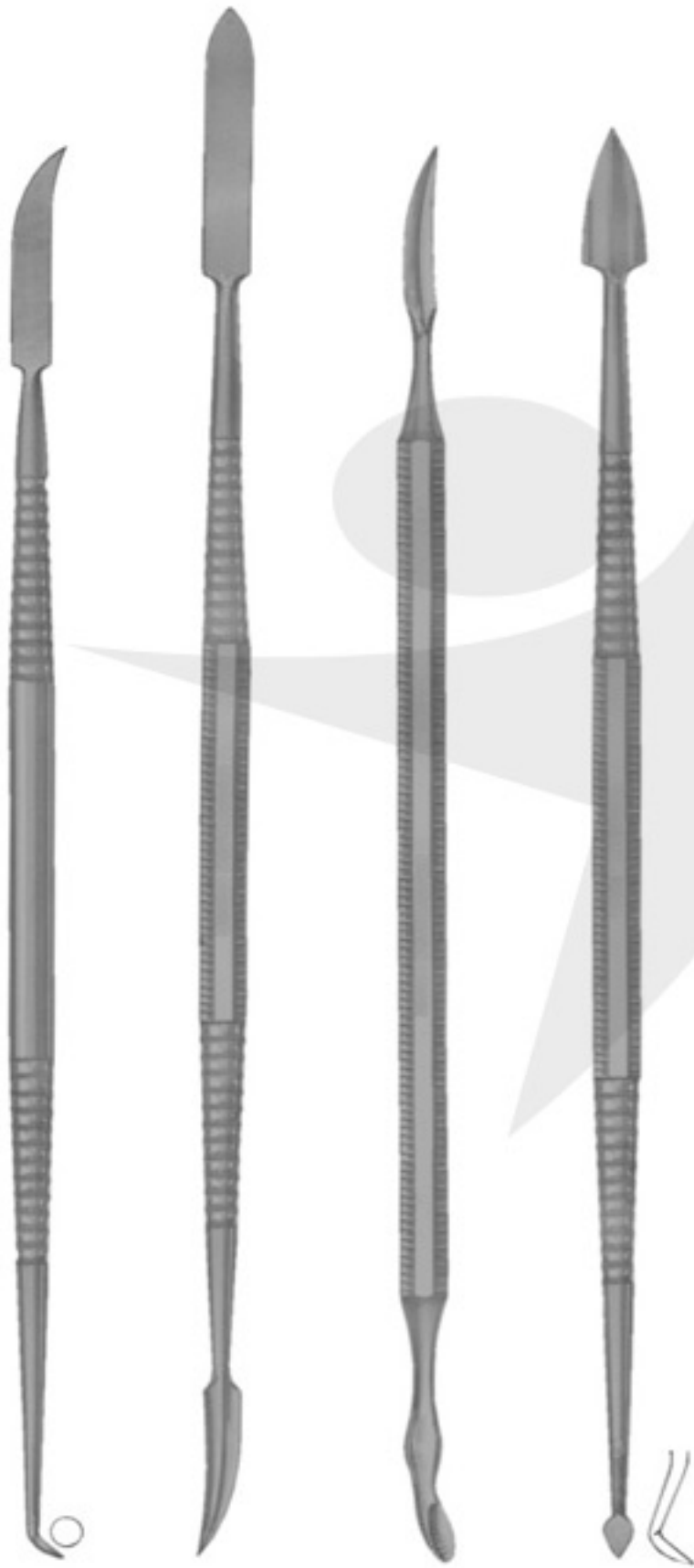

2136
LECRON
Inlay

2137
REEVES

2138
VEHE
Wax

2139
ROACH
Wax

WAX SPATULAS



2140
W-31

2141
W-5

2142
W-7

2143
W-7A

2144
W-7G



Cement Spatulas



2145
AGATHE



2146
C-7



2147
C-5



2148
C-313



2149
C-24A Rigid



2150
C-24 Flexible



2151
C-24 Flexible



2152
24



2153
A6



2154
7 Wax



2155
26



2156
All Metal Spatulas with High Polish
Stainless Steel Blade



2157
31



Spatulas

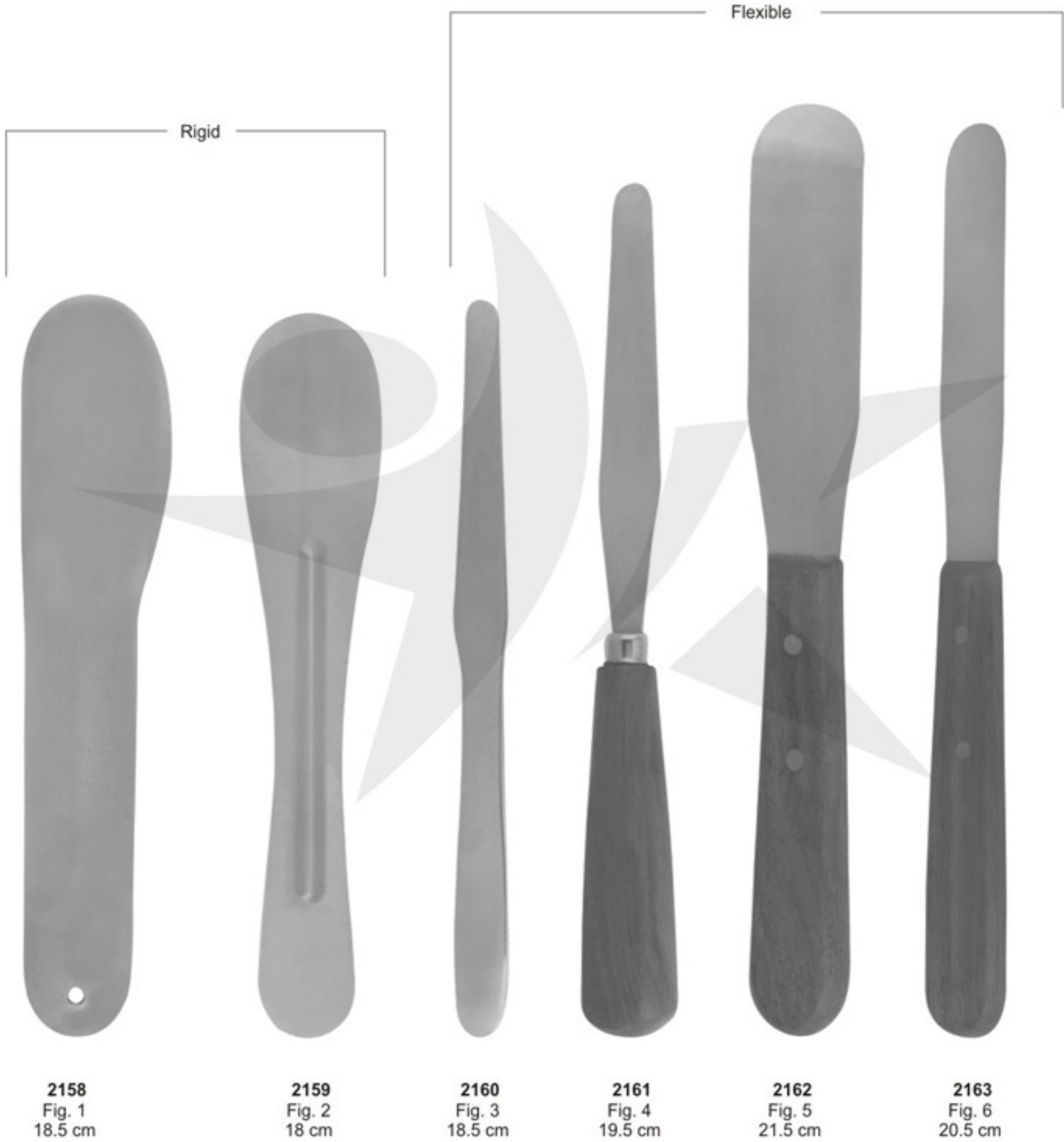



Spatulas

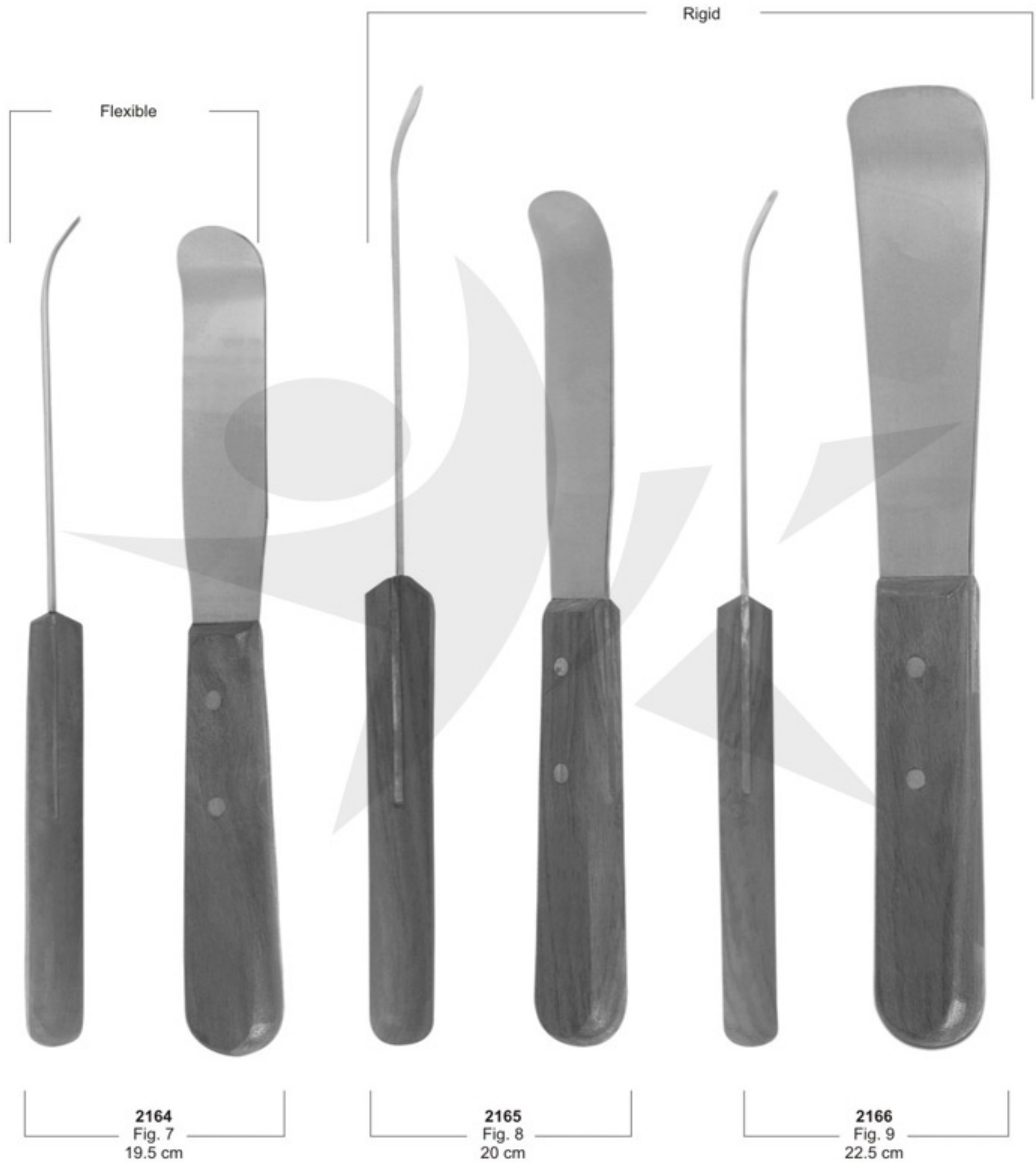



Files, Hoes & Knives

FILES

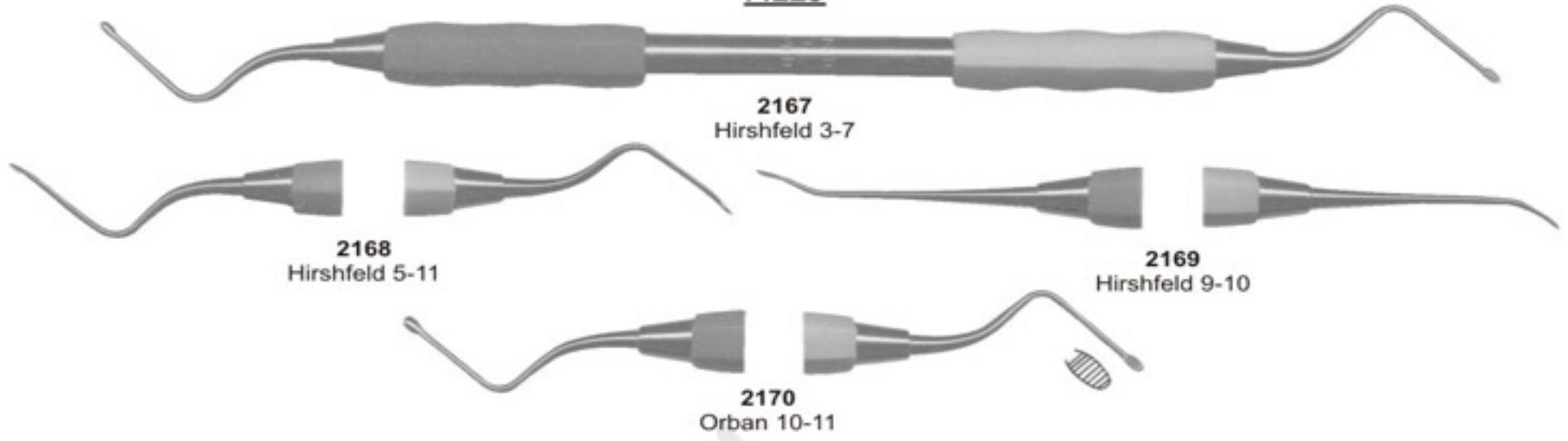

HOES

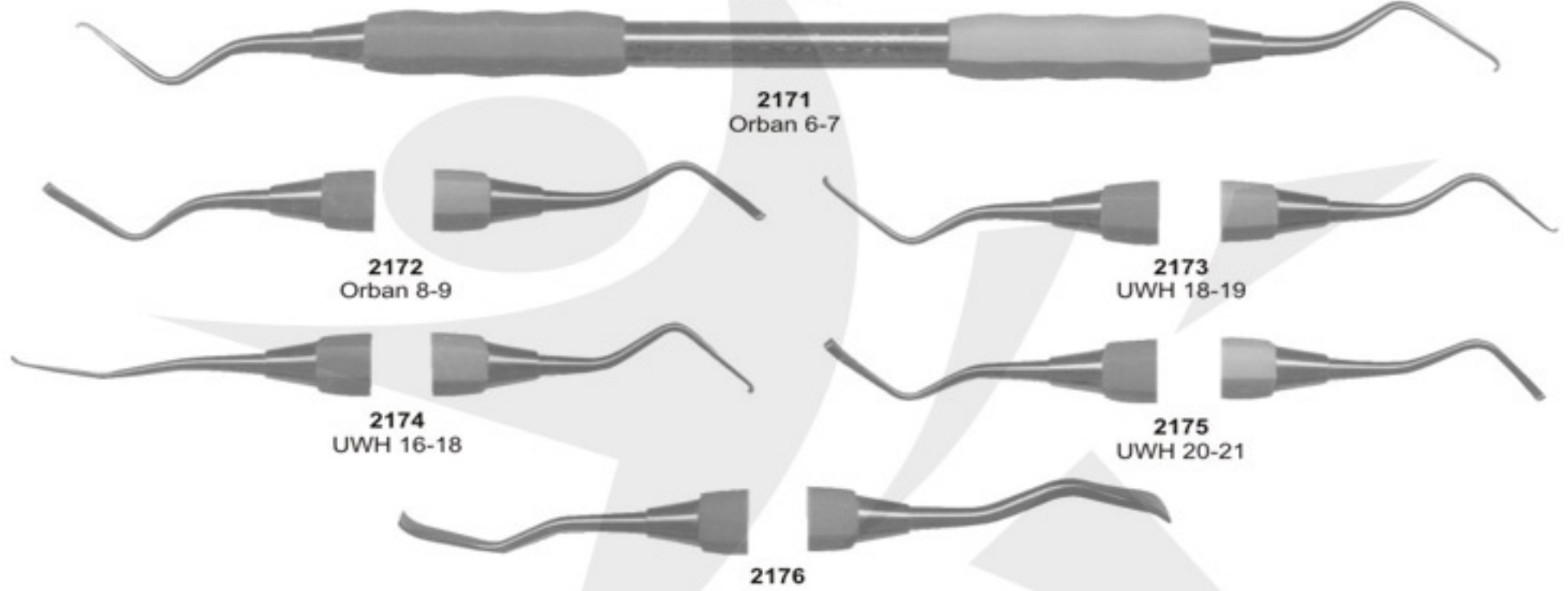

KNIVES

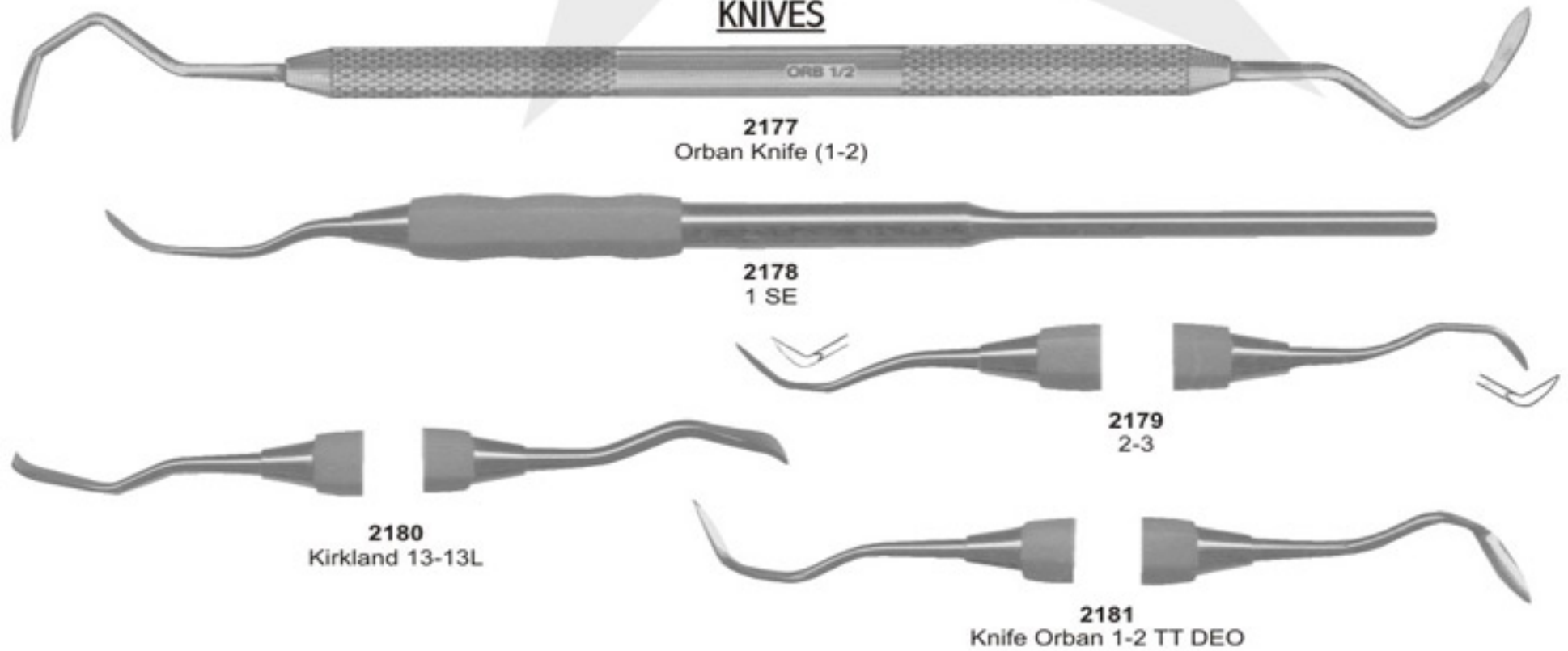



Wax Knives

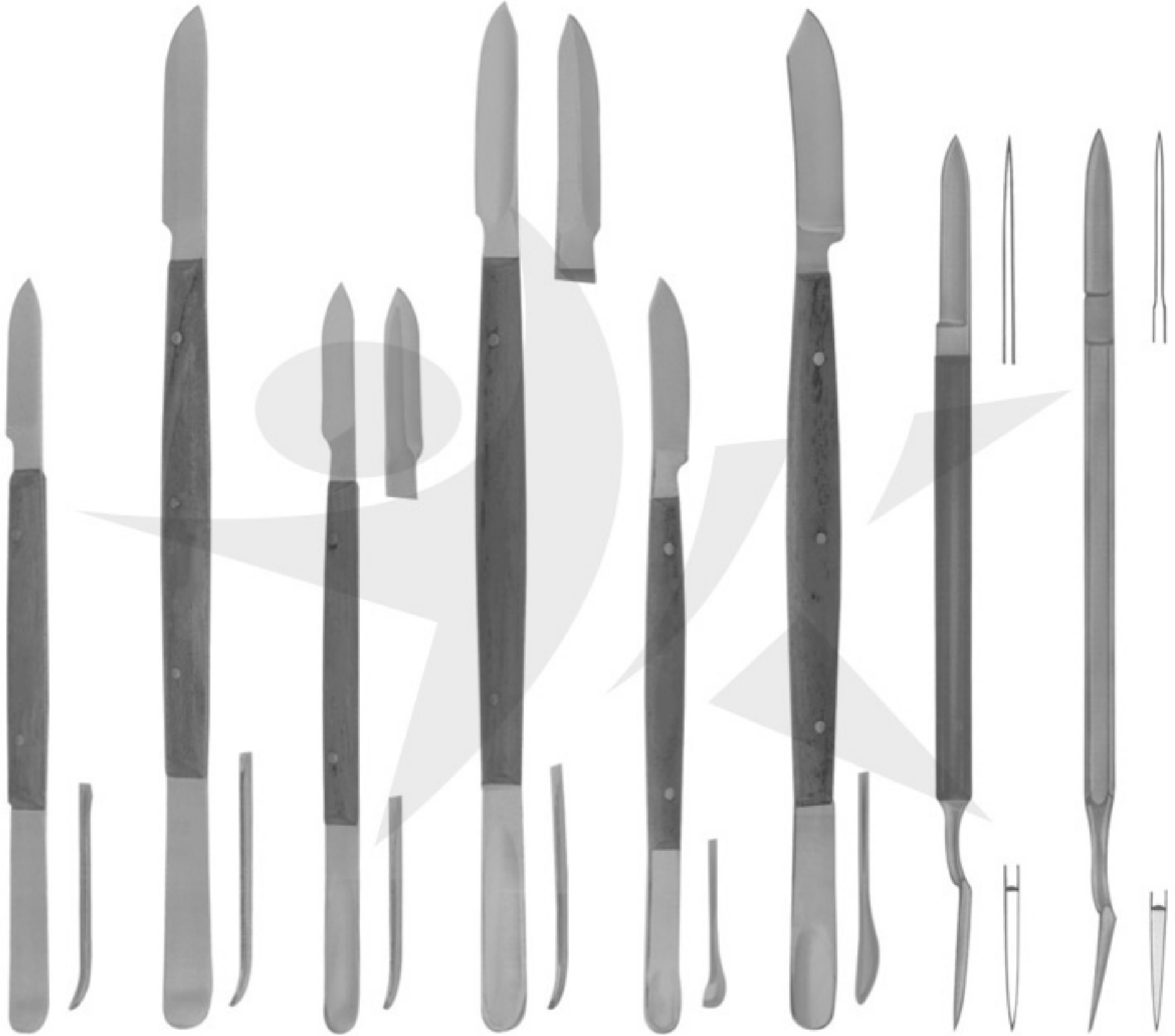

2182
Fahnenstock
Fig. 1
12,5cm

2183
Fahnenstock
Fig. 2
17cm

2184
Lessmann
Fig. 1
12,5cm

2185
Lessmann
Fig. 2
17cm

2186
Con scodellino
Fig. 1
12,5cm

2187
Con scodellino
Fig. 2
17cm

2188
Ermert

2189
Ermert



Wax Knives & Plaster Knives



2190
18 cm
7 1/8"



2191
18 cm
7 1/8"



2192
17 cm
6 3/4"
Gritman



2193
17 cm
6 3/4"
Medicon



2194
Fig. 1
17 cm



2195
22 cm
8 3/4"



2196
22 cm
8 3/4"



2197
Gritman
Fig. 2
17 cm



2198
Fig. 3
16 cm



2199
Fig. 4
16 cm



Crane-Kaplan, Chisels

CRANE-KAPLAN

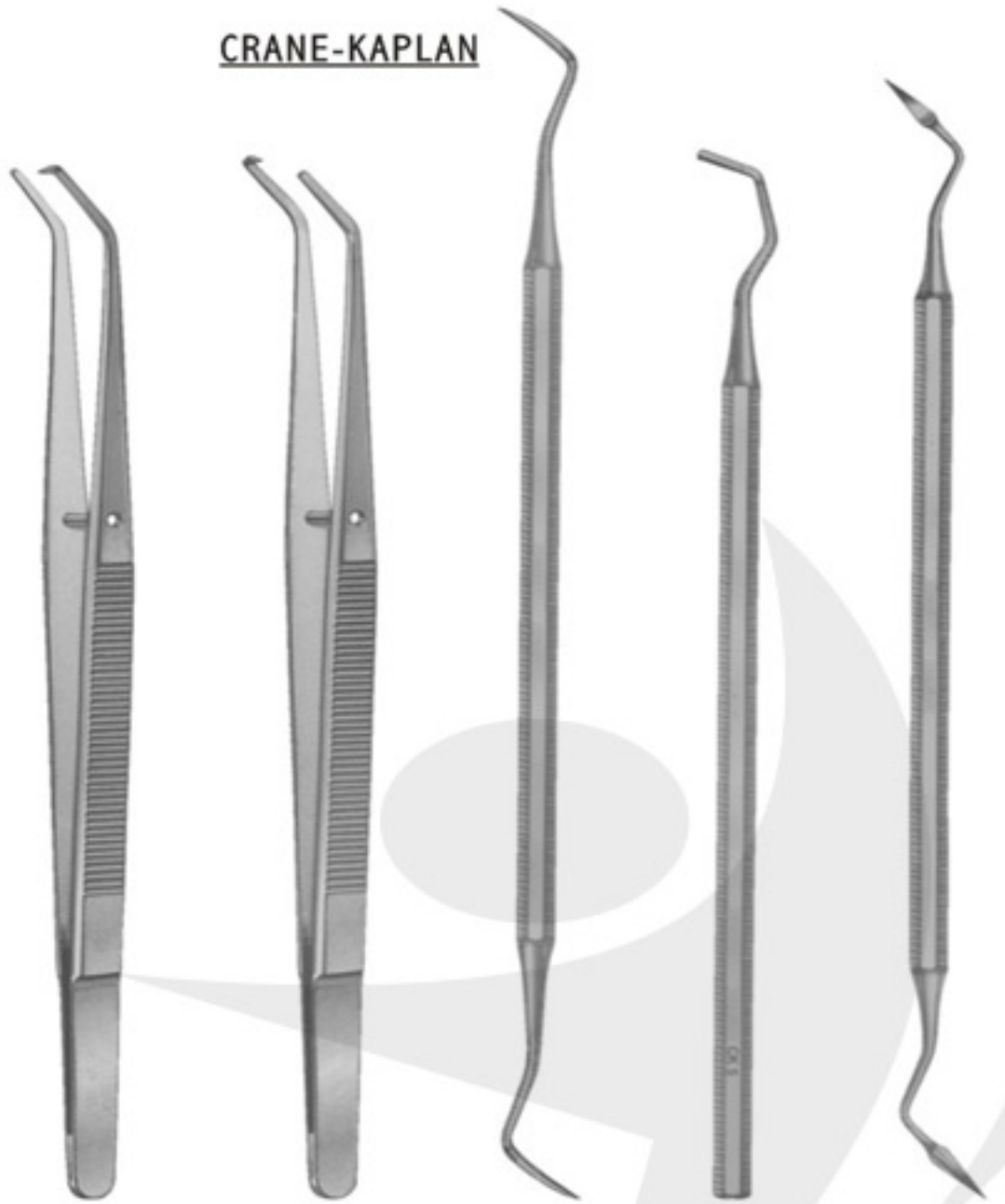

2200
Ck1
Pocket Marker

2201
Ck2
Pocket Marker

2202
Knife

2203
Dissector

2204
Scaler

OCHSENBEIN



2205
Ochsenbein
Fig. 1

2206
Ochsenbein
Fig. 2

2207
Ochsenbein
Fig. 4

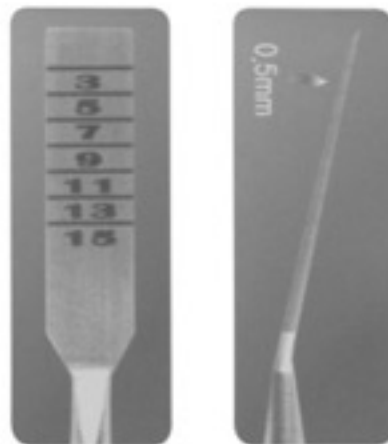

Split Chisel Set



2208
Split Chisel
6 mm Curved



2209
Split Chisel
6 mm Straight



2210
Split Chisel
4 mm Curved



2211
Split Chisel
4 mm Straight



Bone Currettes

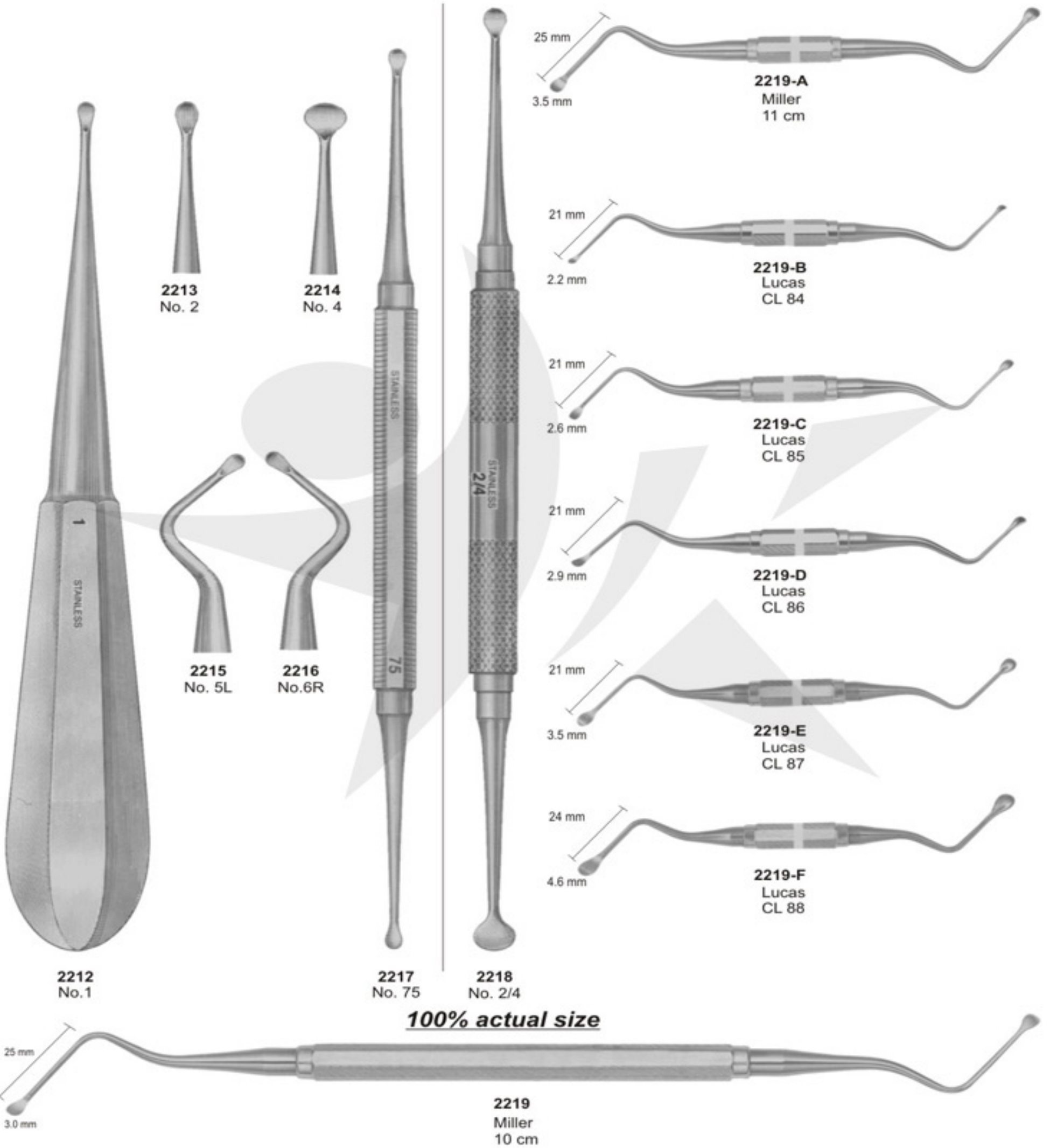



Bone Files



2220
No. 10

2221
No. 33

2222
MILLER
No. 33

2223
MILLER
No. 64



Bone Files

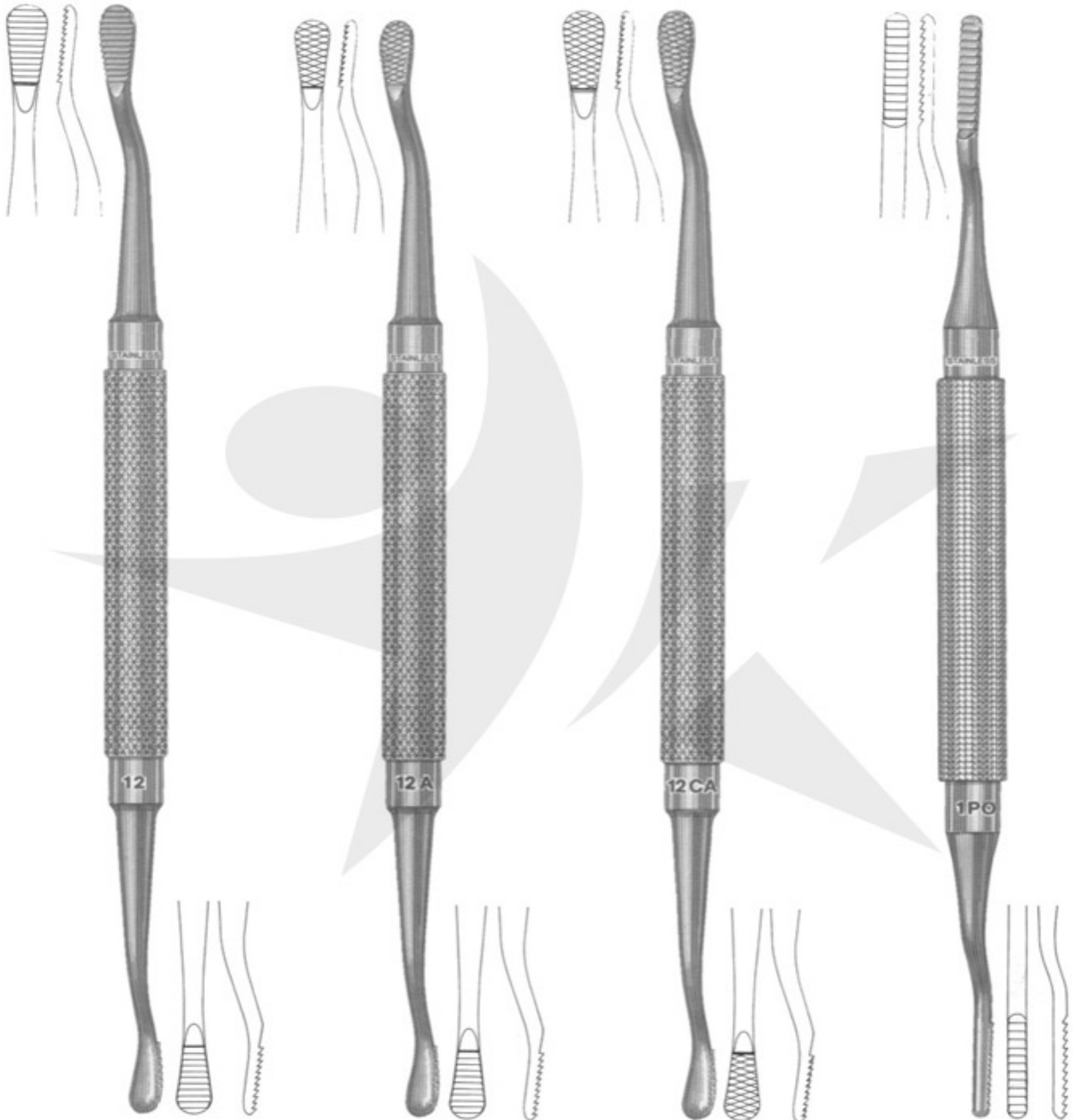

2224
HOWARD
No. 12

2225
HOWARD
No. 12A

2226
HOWARD
No. 12CA

2227
POLOKOFF
No. 1



Bone Chisels

GARDNER

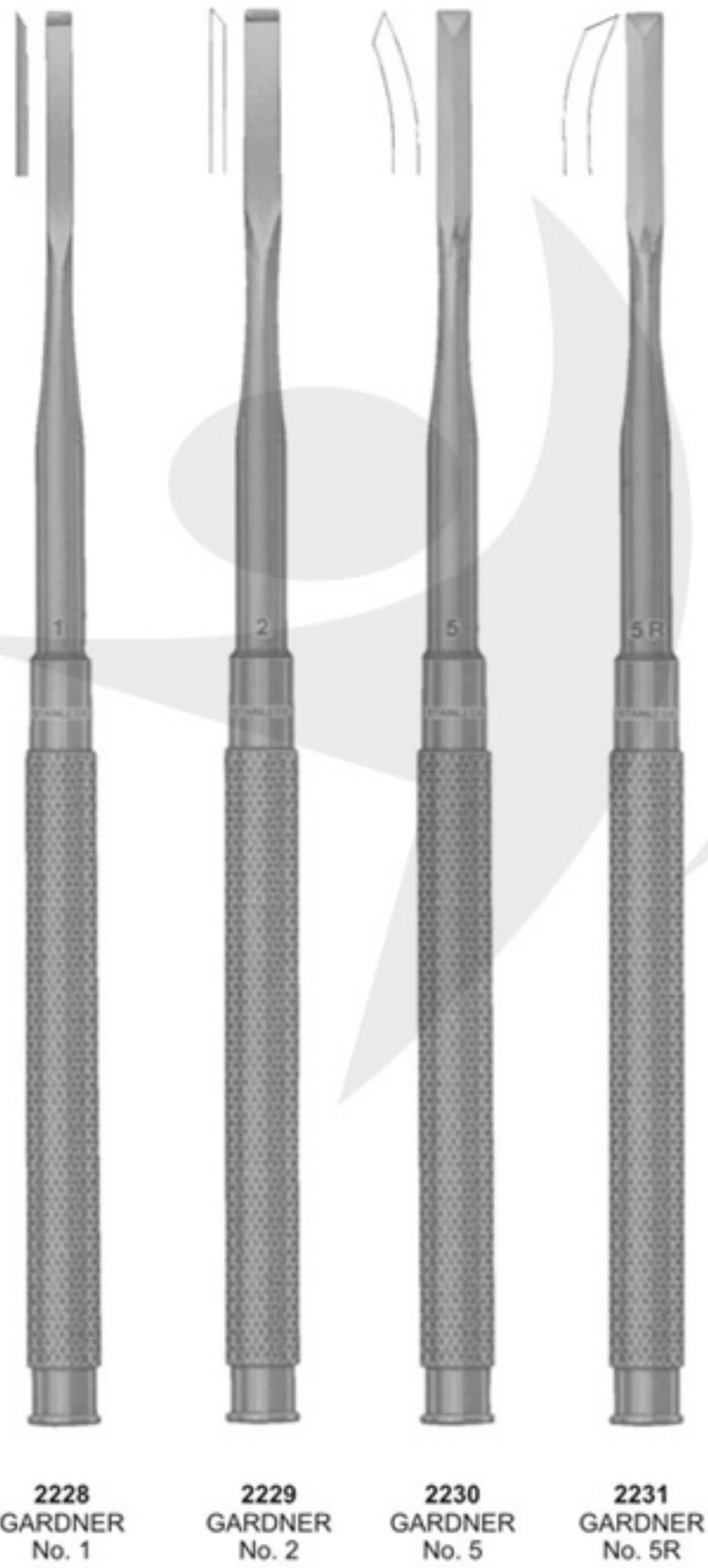

WAKEFIELD





Bone Chisels, Bone Mallets

Bone Chisels and Gouges

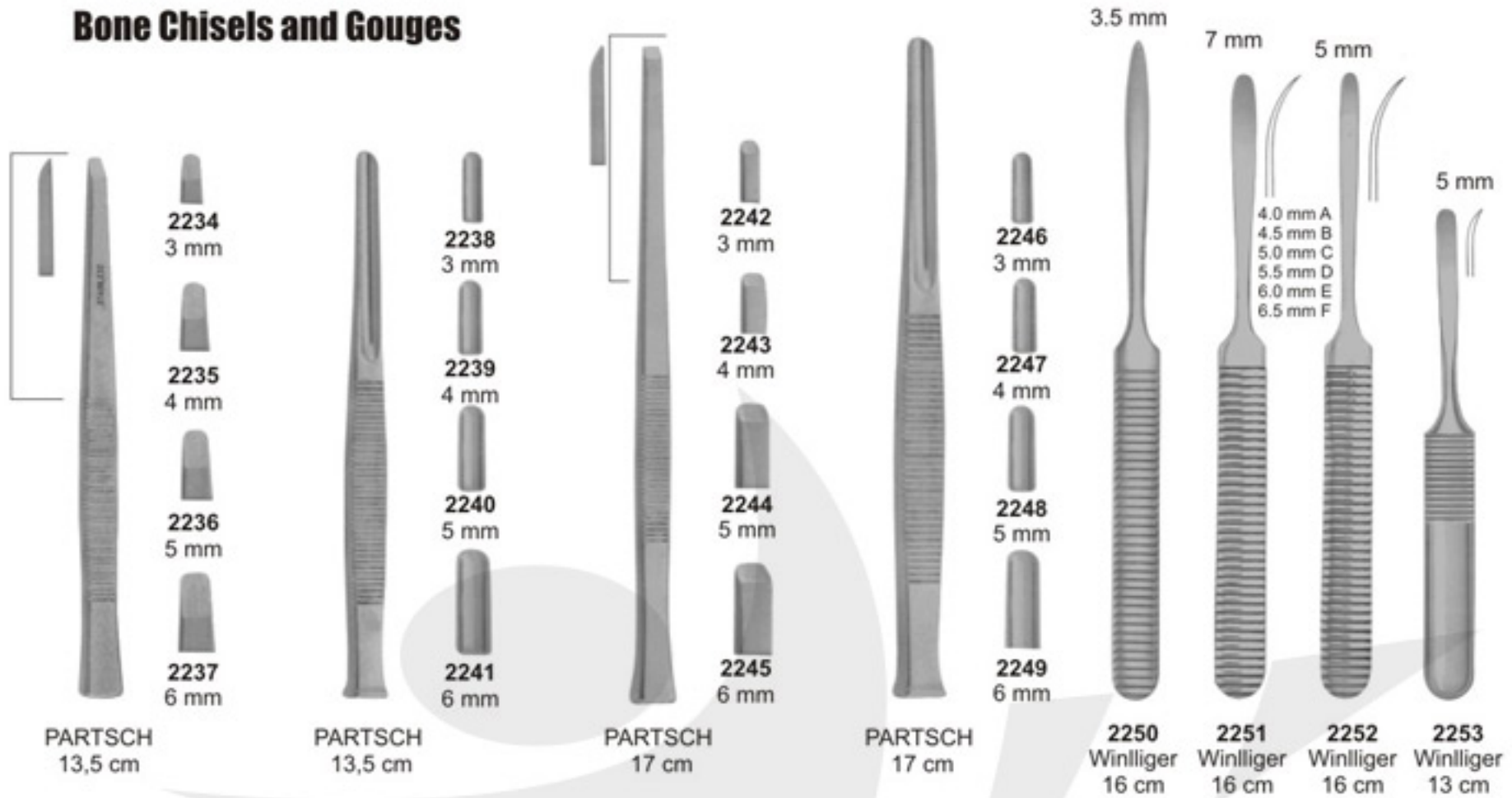

Martelli chirurgici Mallet

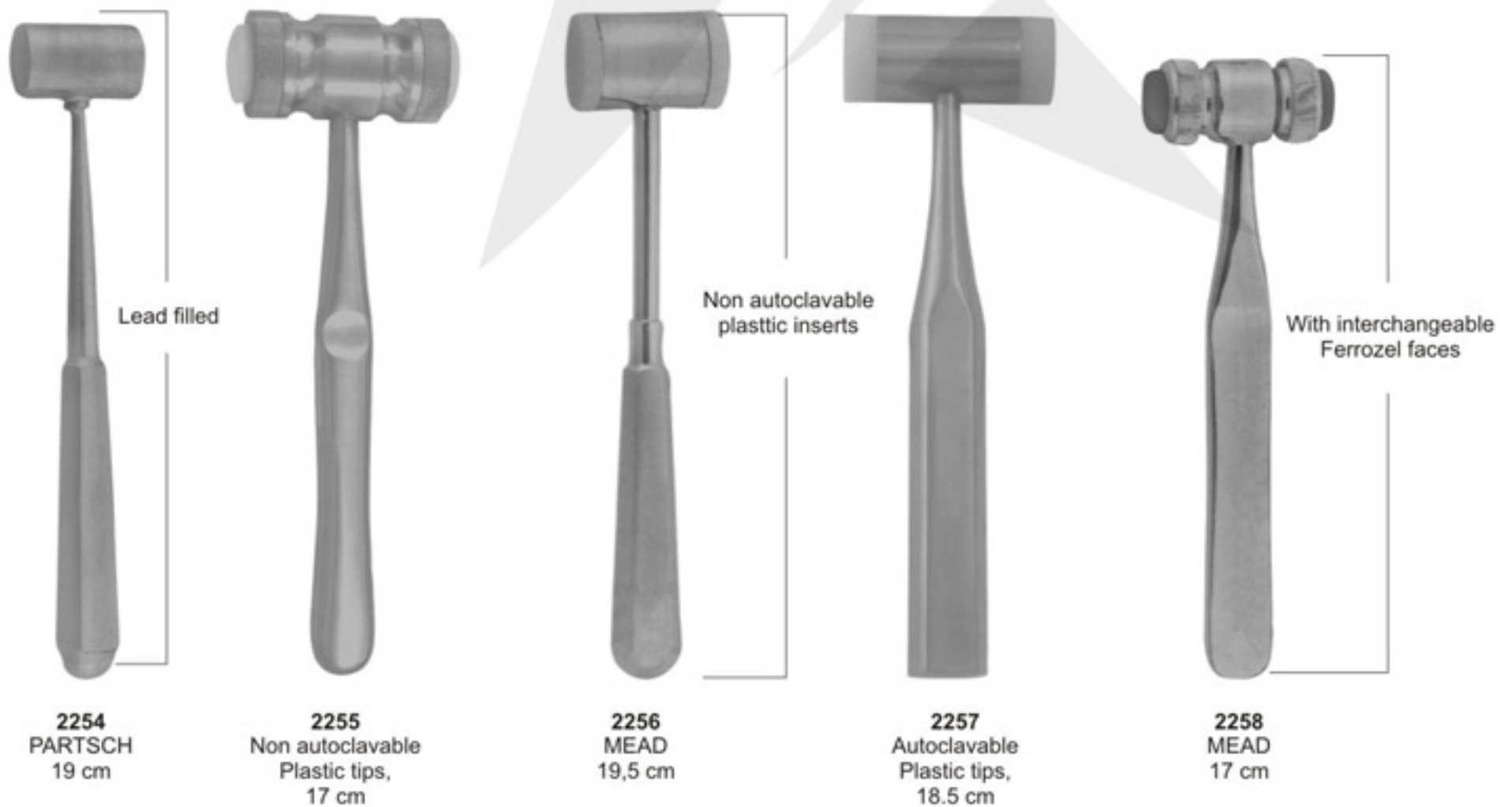



Crown Removers

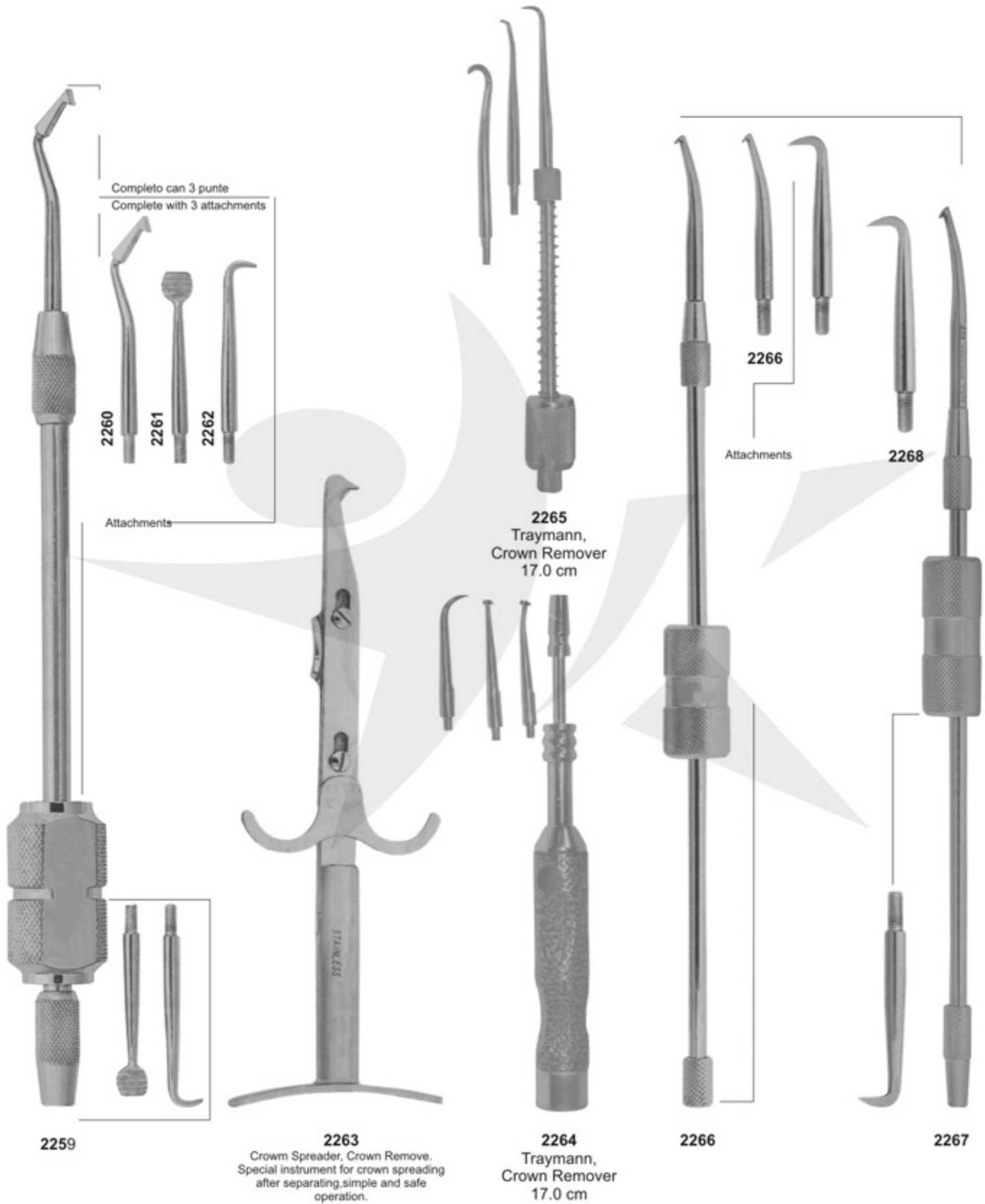



Crown Instruments





Crown Instruments

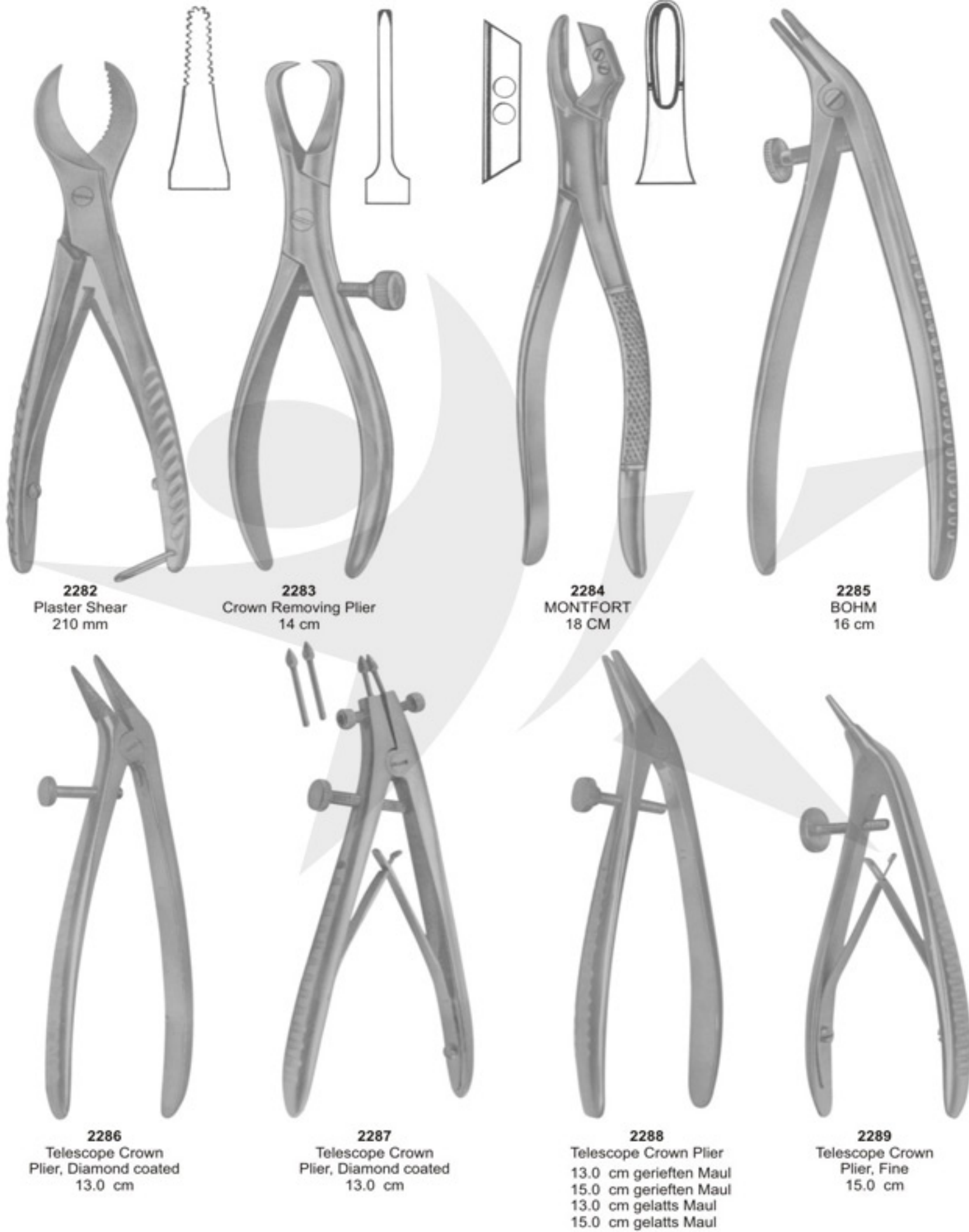

2282
Plaster Shear
210 mm

2283
Crown Removing Plier
14 cm

2284
MONTFORT
18 CM

2285
BOHM
16 cm

2286
Telescope Crown
Plier, Diamond coated
13.0 cm

2287
Telescope Crown
Plier, Diamond coated
13.0 cm

2288
Telescope Crown Plier
13.0 cm gerieften Maul
15.0 cm gerieften Maul
13.0 cm gelatts Maul
15.0 cm gelatts Maul

2289
Telescope Crown
Plier, Fine
15.0 cm



Implants Instruments

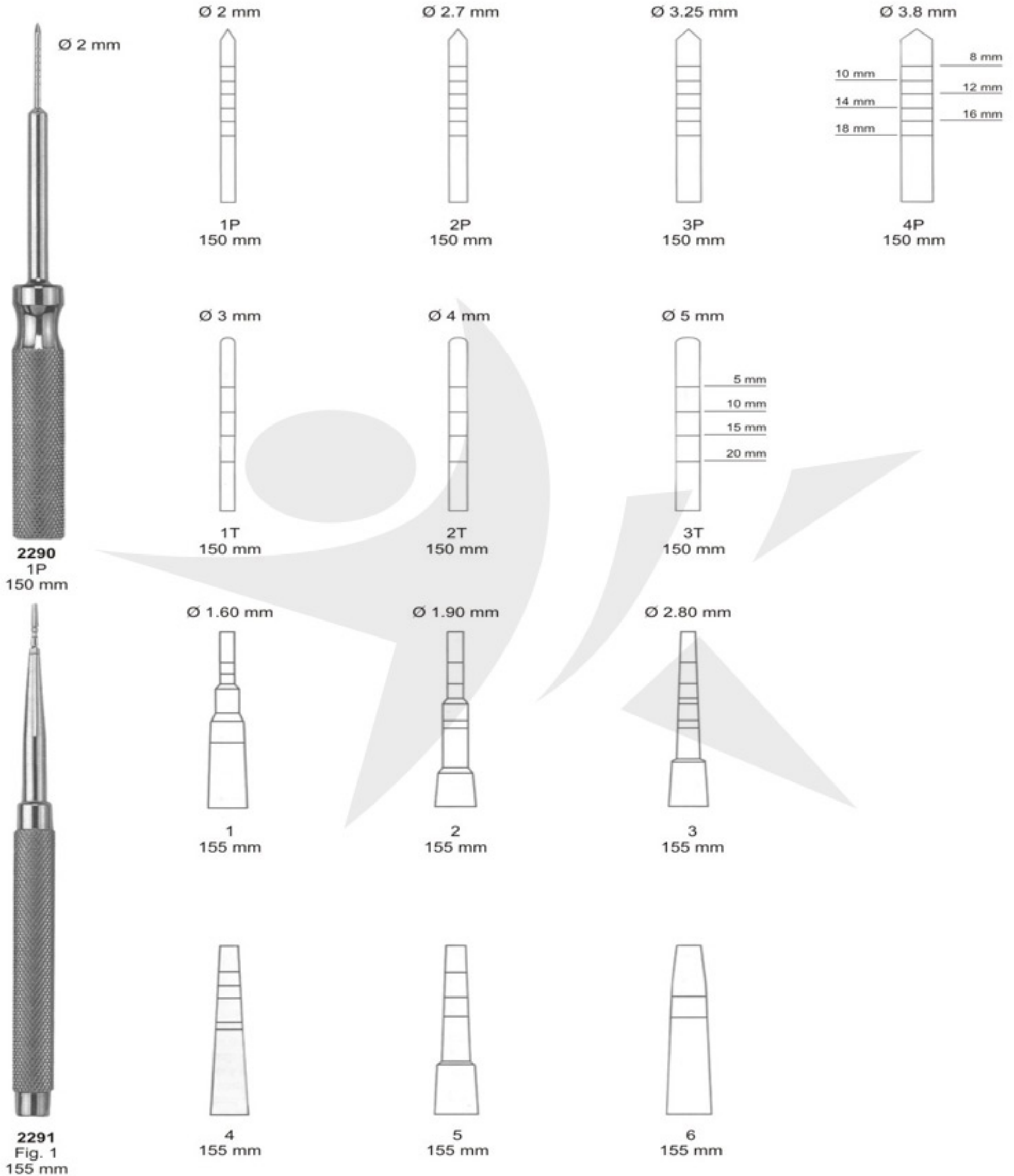



Implants Instruments



2292
Fig. 1B
165 mm

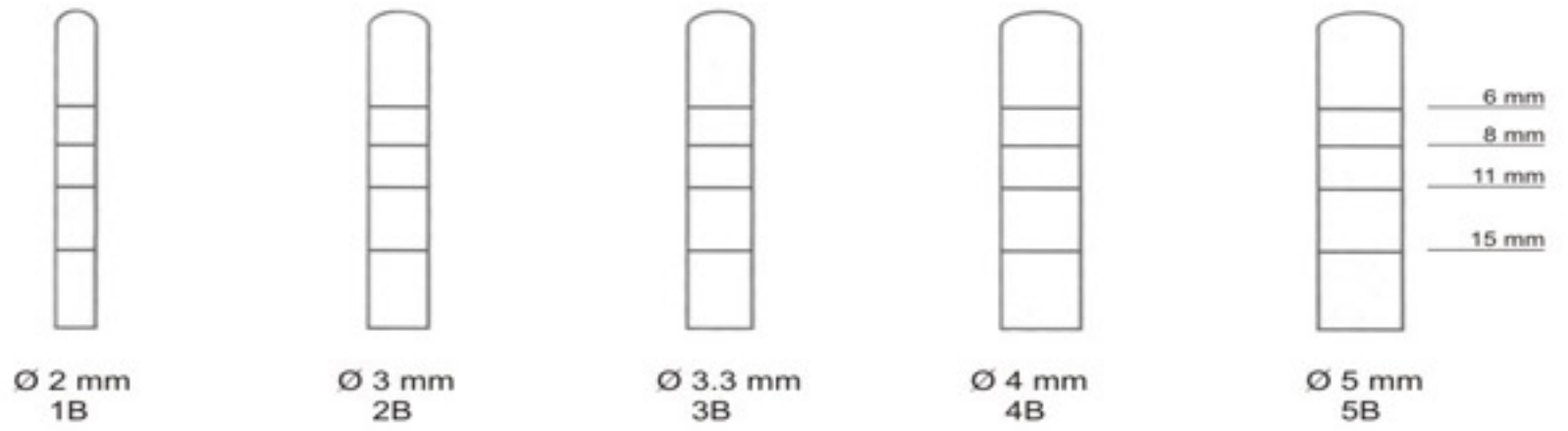

Ø 2 mm 1BCC Ø 3 mm 2BCC Ø 3.3 mm 3BCC Ø 4 mm 4BCC Ø 5 mm 5BCC



2293
Fig. 1
155 mm

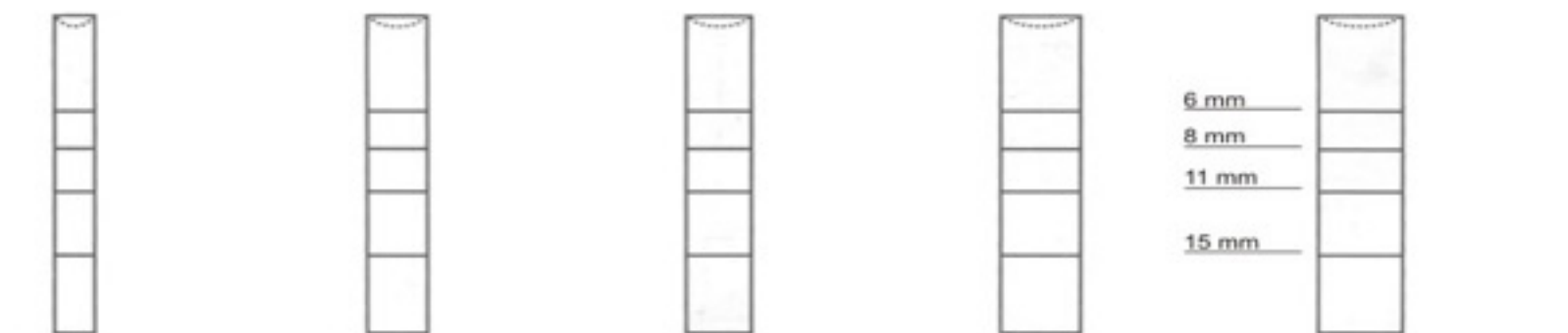
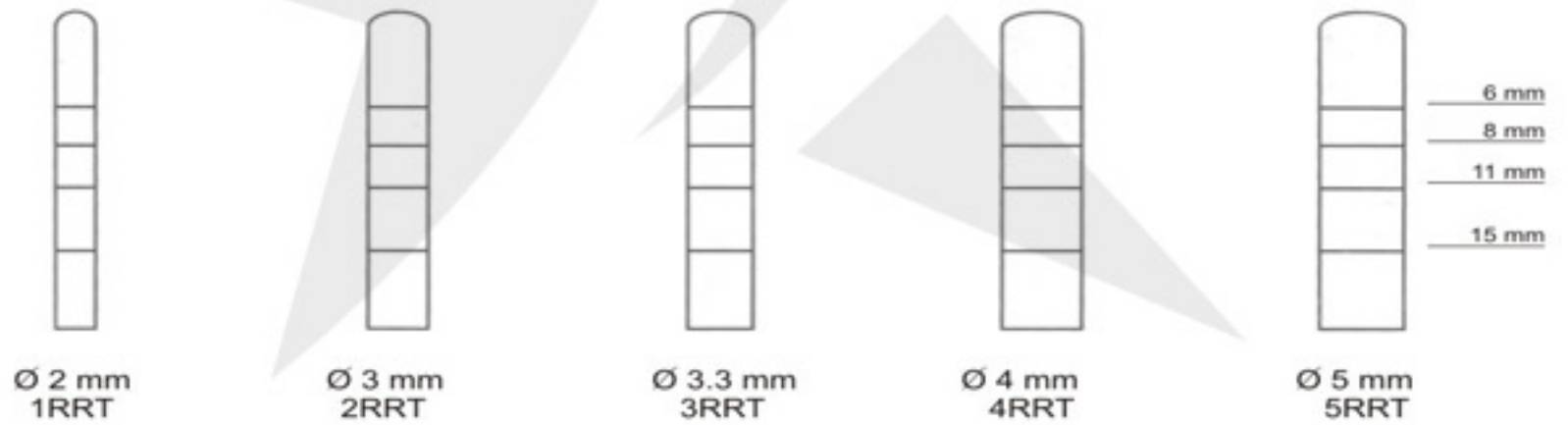

Ø 2 mm 1RRC Ø 3 mm 2RRC Ø 3.3 mm 3RRC Ø 4 mm 4RRC Ø 5 mm 5RRC



Implants Instruments

Endo guns for retrograds.

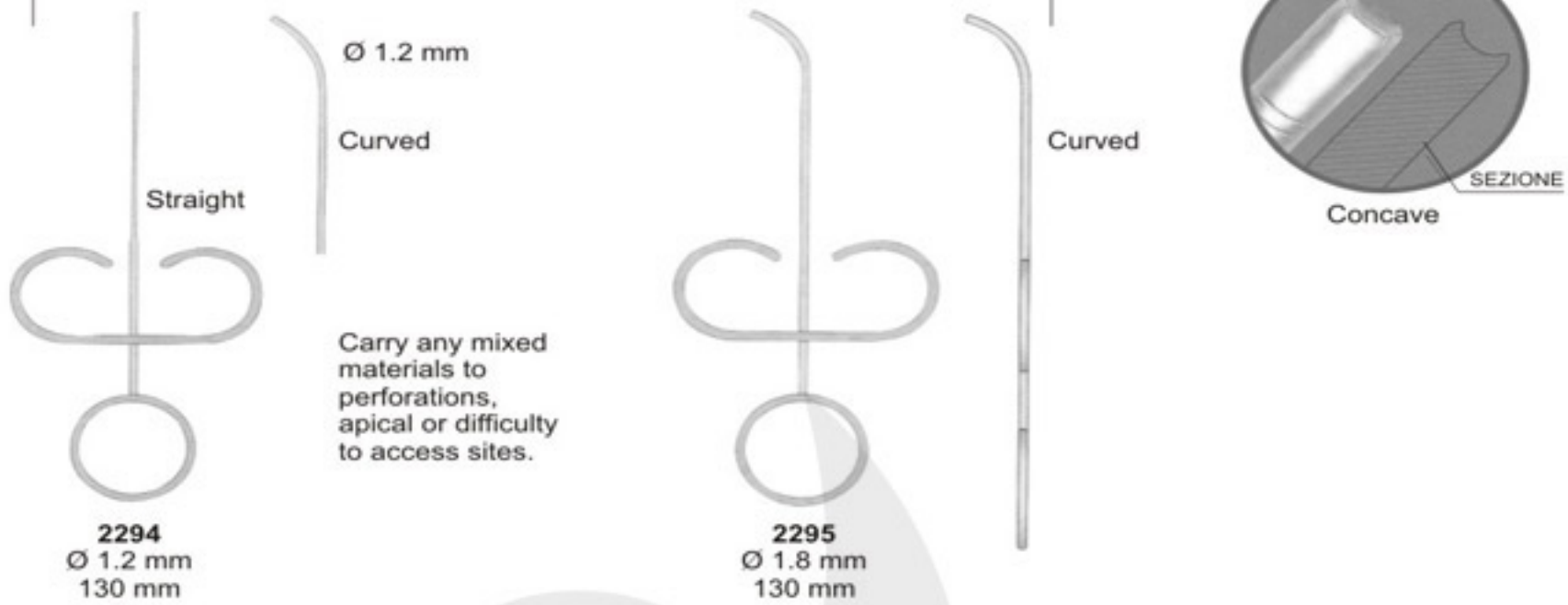

Bone Injectors

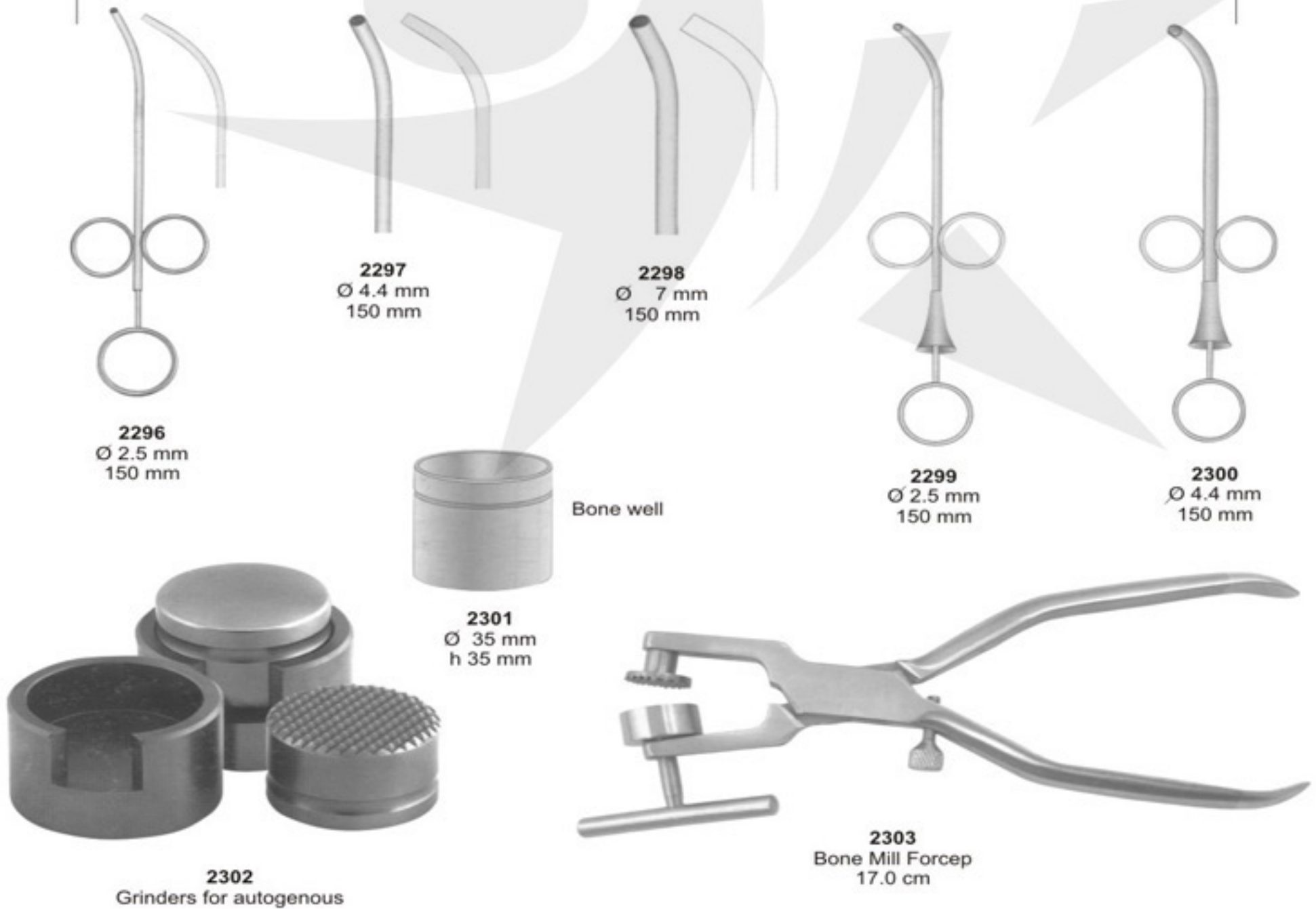



Suction Tubes, Bone Pluggers & Rongeurs

Suction Tubes



Bone Pluggers

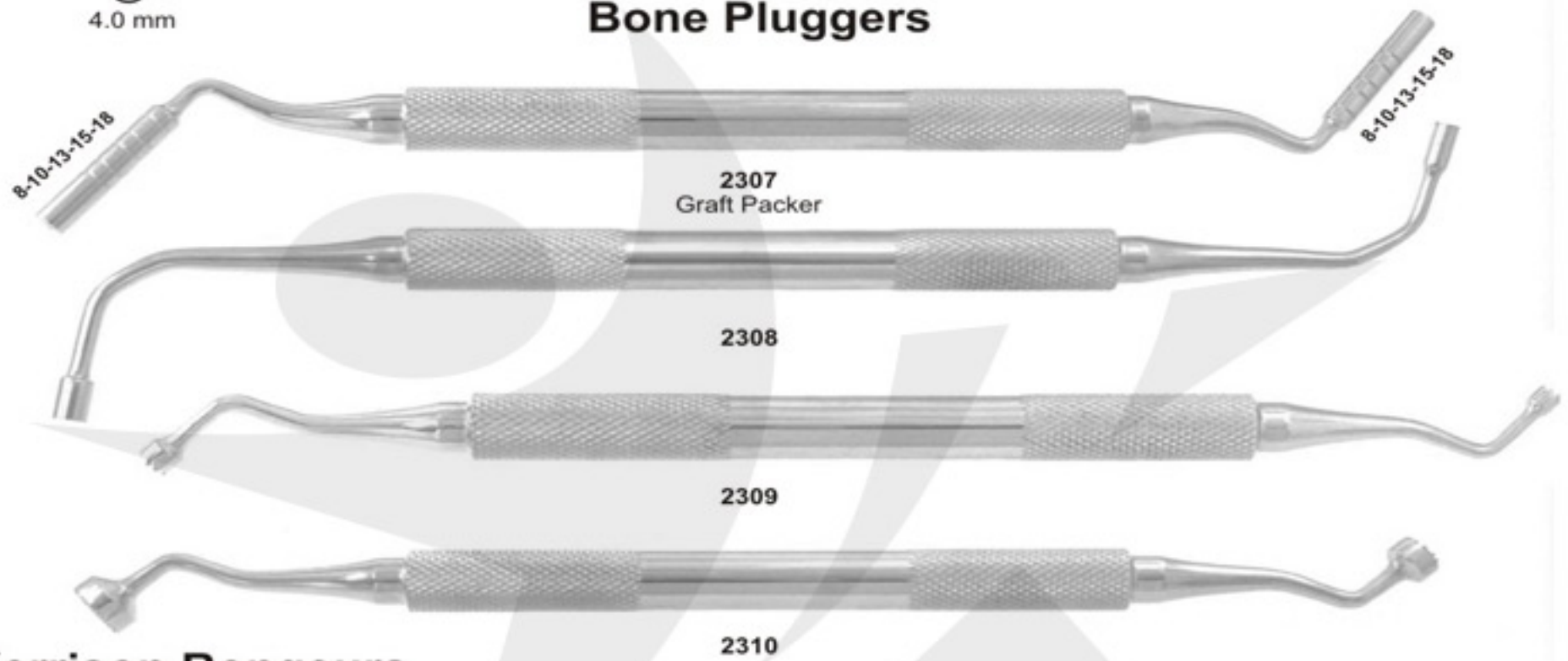

Kerrison Rongeurs



(1.5 mm inside) 2311
 (2.0 mm inside) 2312
 (3.0 mm inside) 2313
 (4.0 mm inside) 2314
 (4.5 mm inside) 2315
16.5 cm



(1.0 mm inside) 2316
 (2.0 mm inside) 2317
 (2.50 mm inside) 2318
16.5 cm





Implants Instruments

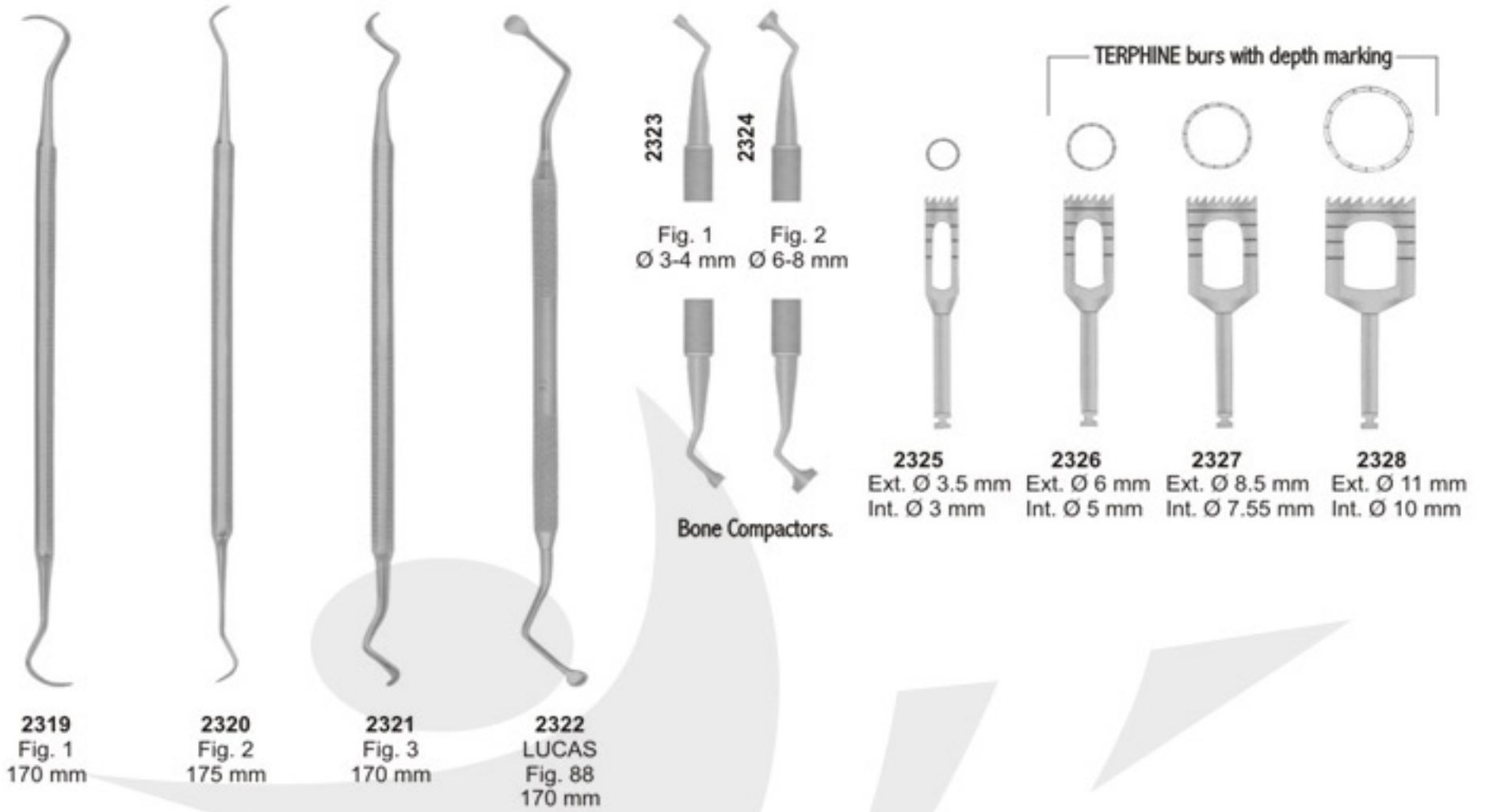

Sinus lift instruments

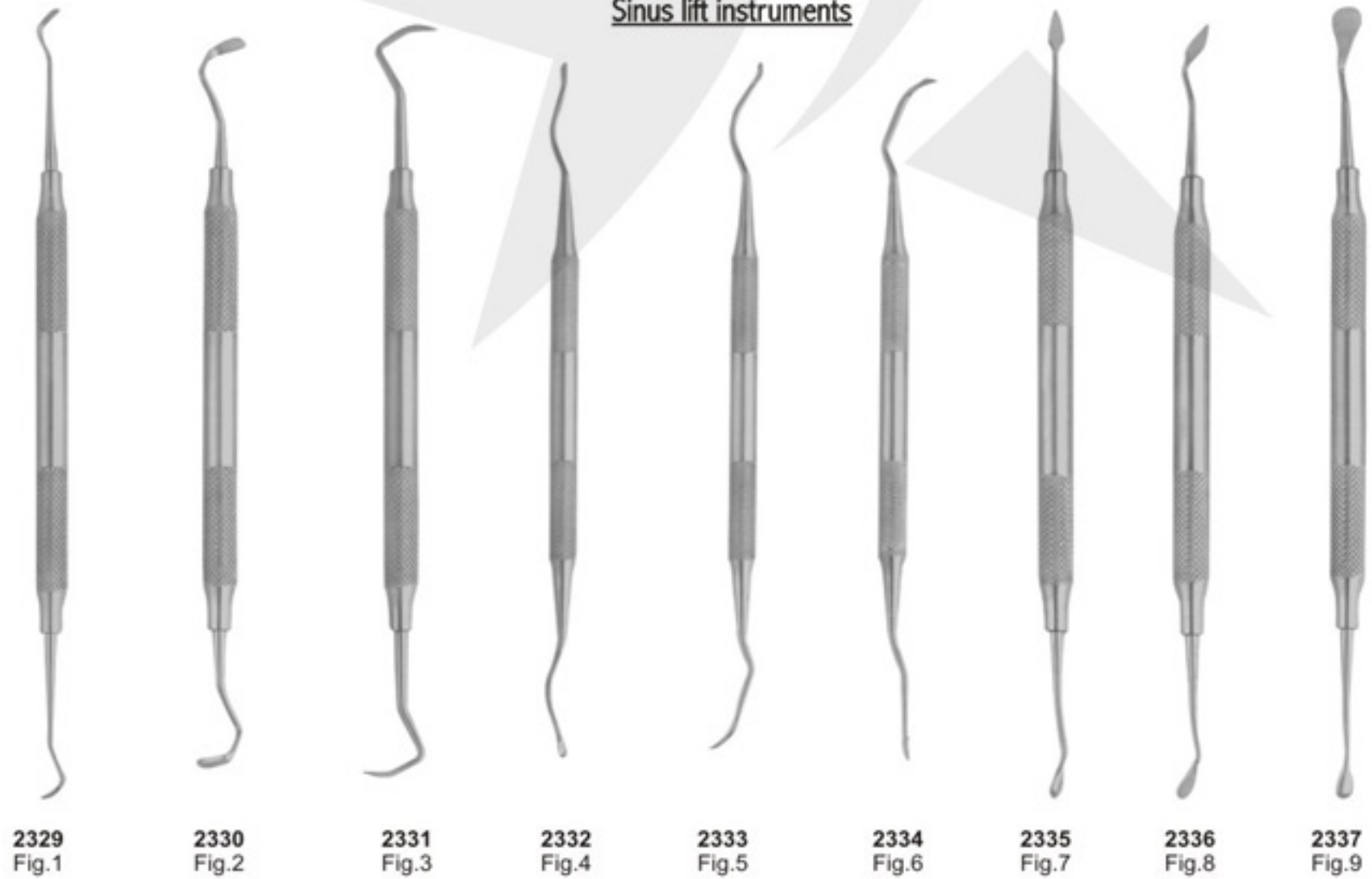



Suction Tubes

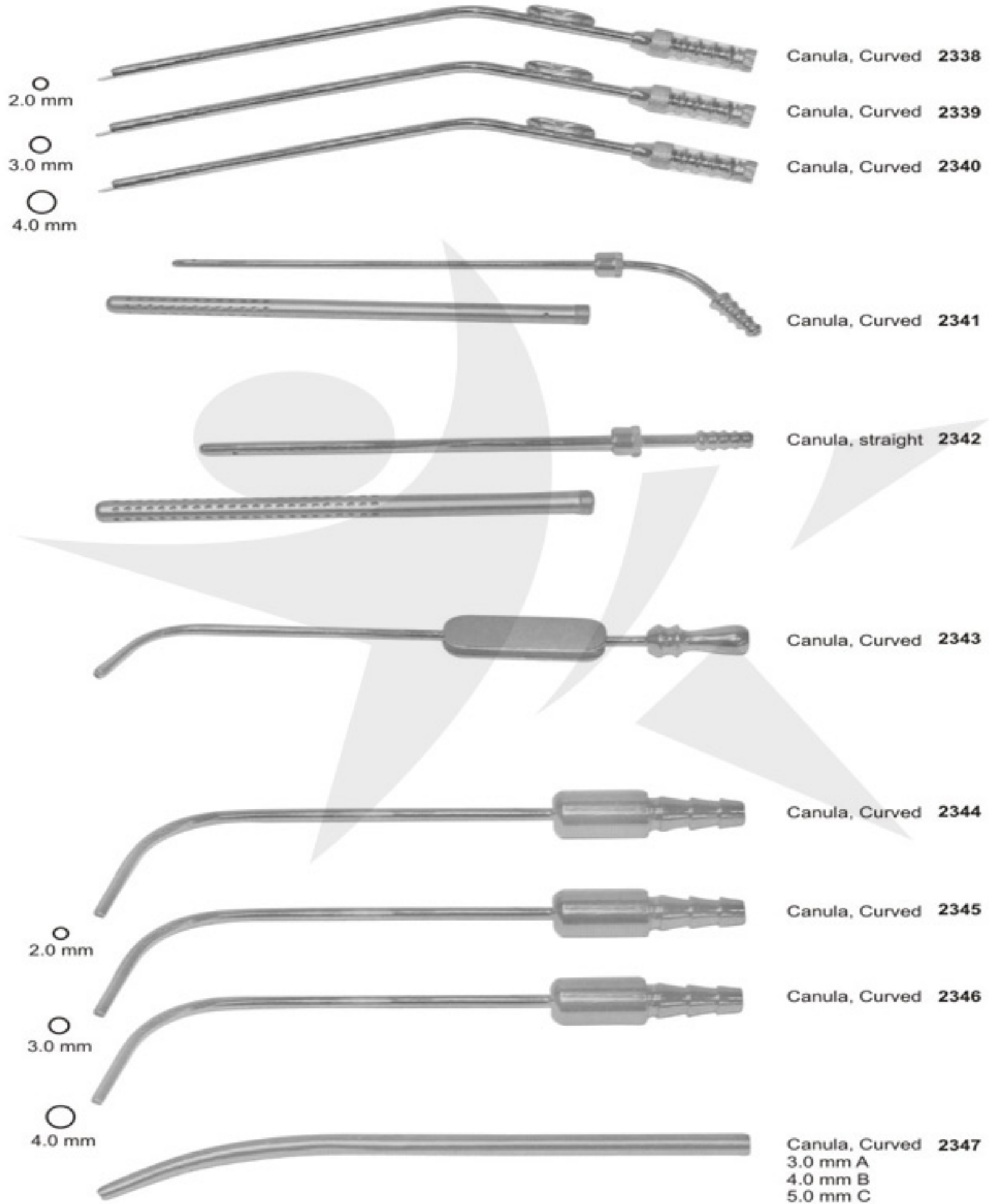



Measuring Instruments



2348
BOLEY Gauge



2349
ZURICHER
130 mm



2350
VERNIER
12 cm



2351
VERNIER



2352
VERNIER Gauge



2353
VERNIER Gauge

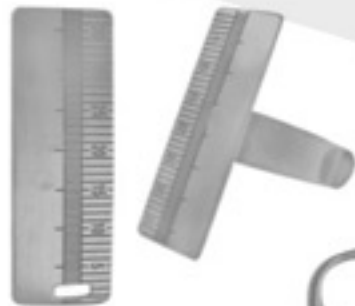

2355
Finger Ruler



2354
LWANSON
Crown Gauge

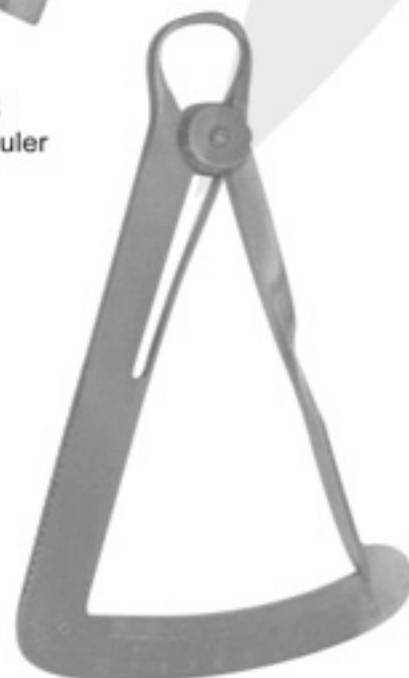

2356
LWANSON
Crown Gauge



2357
Sliding Gauge
10 cm



2358
Spring Bow Divider
6" Radius



2359
VERNIER
Gauge

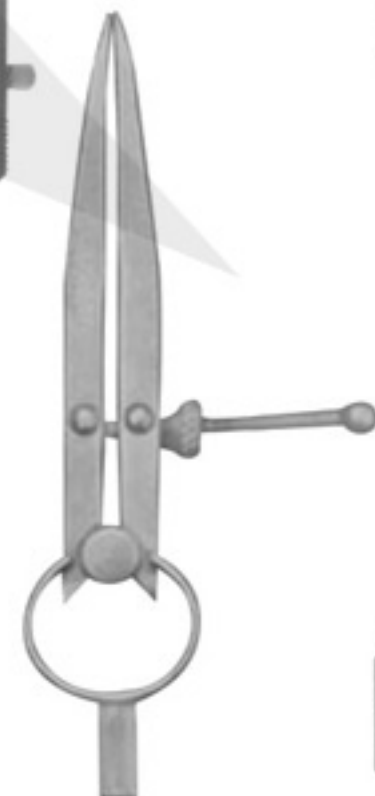

2360
ALBEE



2361
Height Gauge
Wick Type



Bone Gauge & Measuring Instruments



2362
Bone Gauge



2363
Bone Caliper
15 cm



2364
Castroviejo



2365 A
Castroviejo
Curved

2365 B
Straight

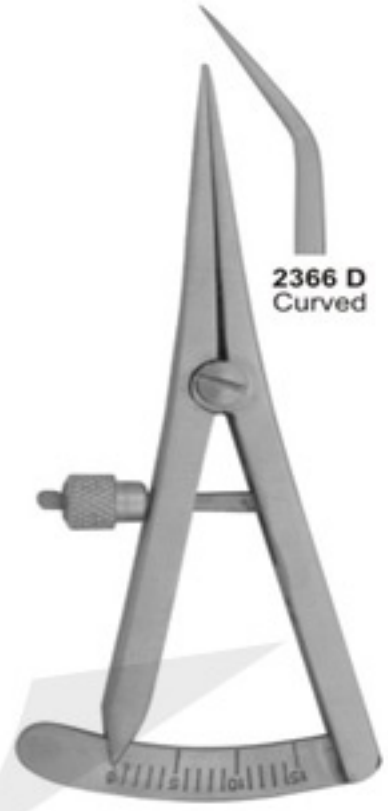

2366 C
Castroviejo
Straight

2366 D
Curved



2367
Gauge

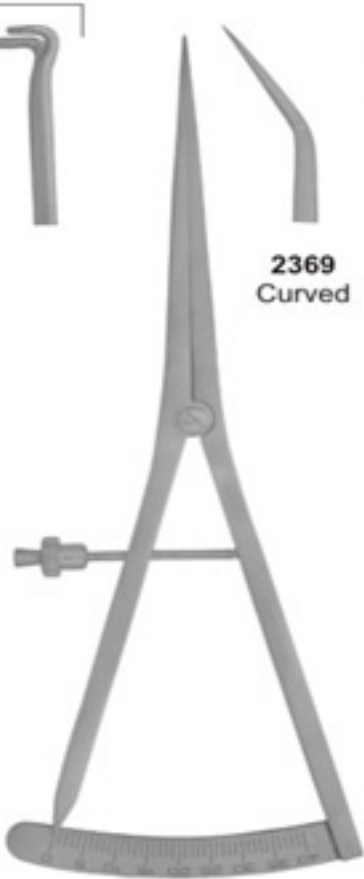

2368
Castroviejo
Straight



2369
Curved



2370 A



2370
Castroviejo
Straight



2371
Curved



2373
Boone - Gauge



2372
Castroviejo



2374 **2375**
Curved Straight



2376
Bracket Gauge. Ant/Post



Amalgam Guns & Carriers

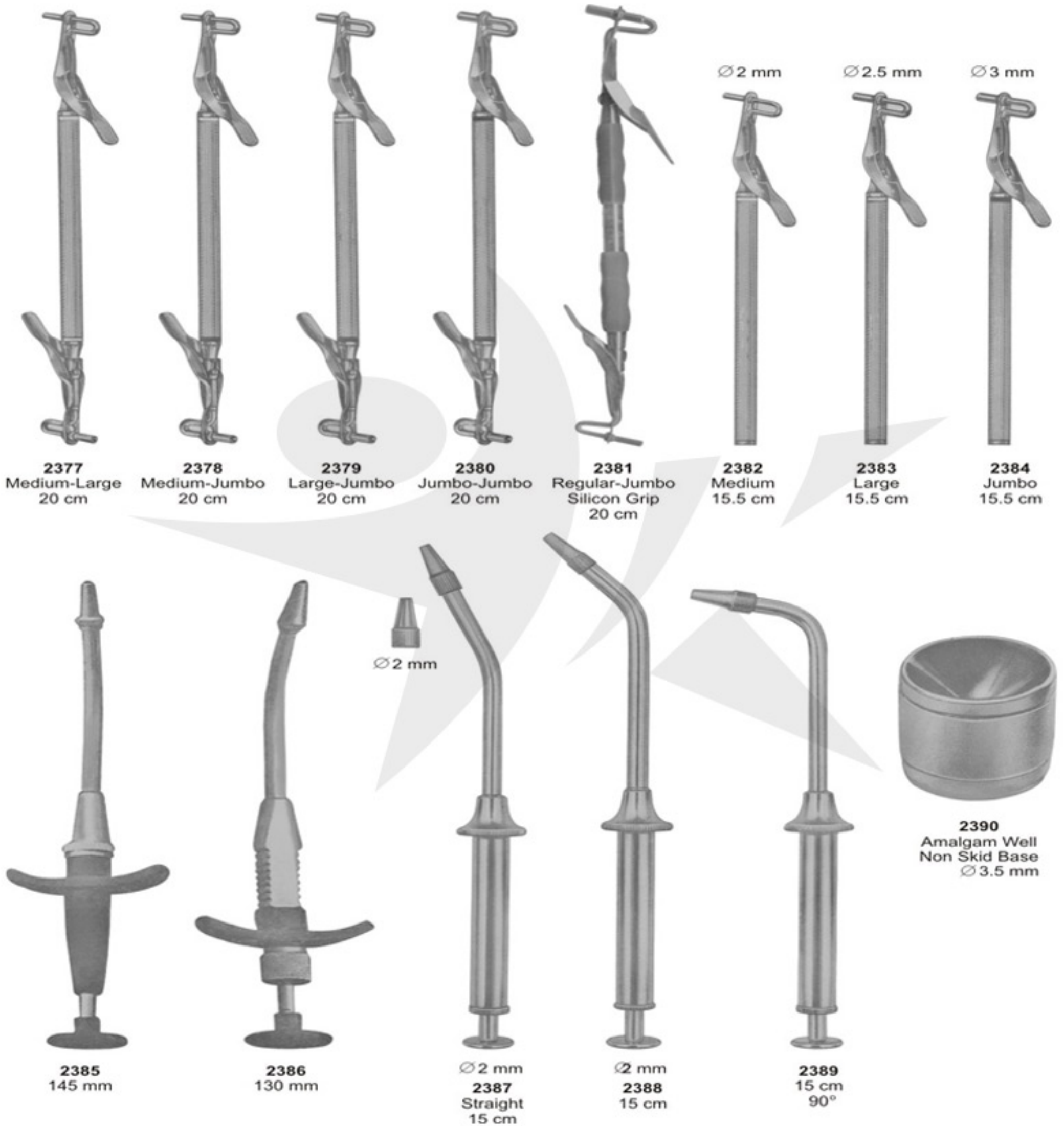



Retainers, Bands, Strip Holder Clips, Napkin Holders

Retainers

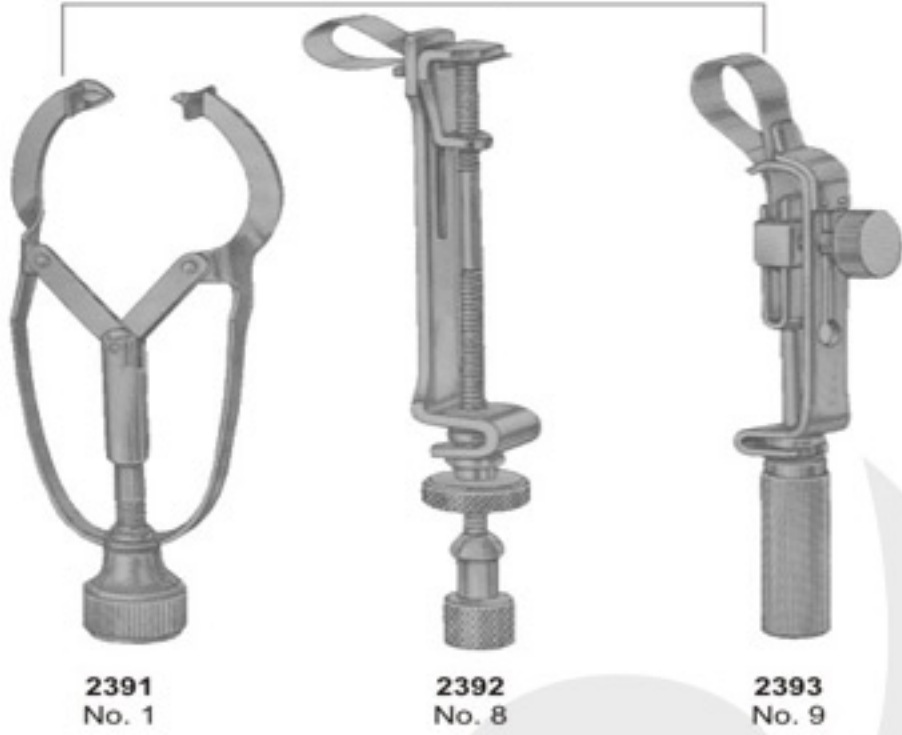

"Tofflemire" Type Retainers

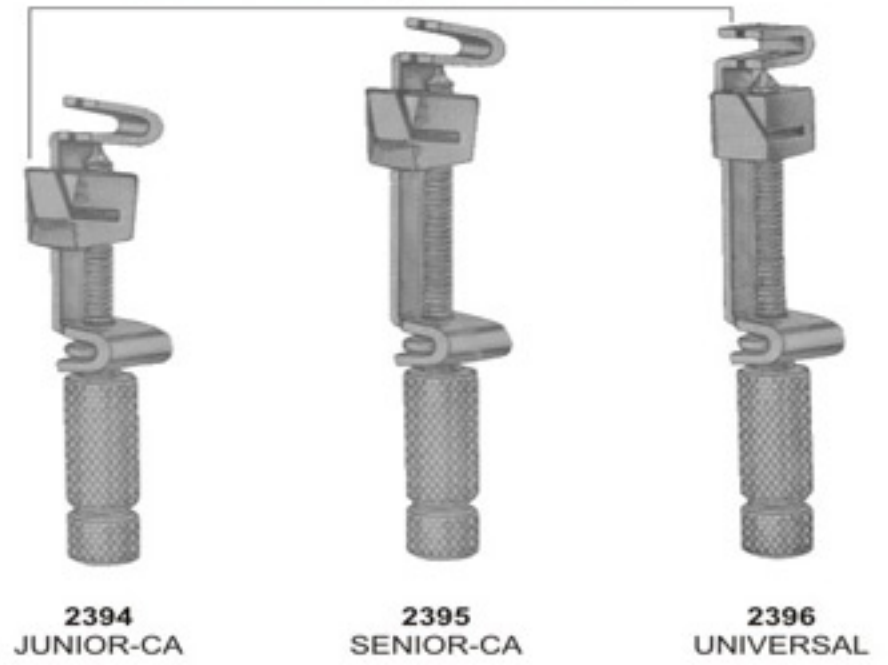

Tofflemire Bands

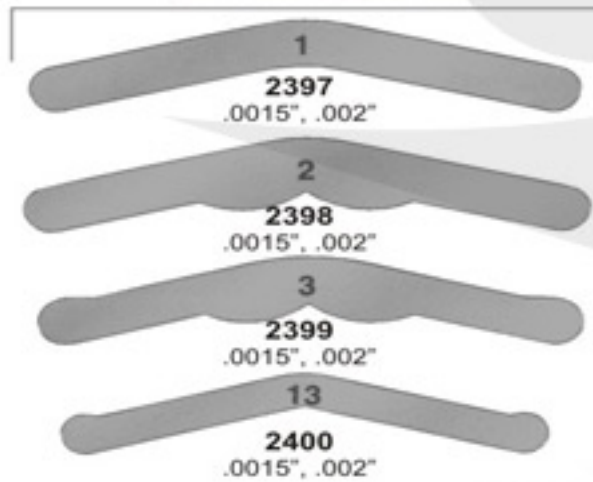

Napkin Holders

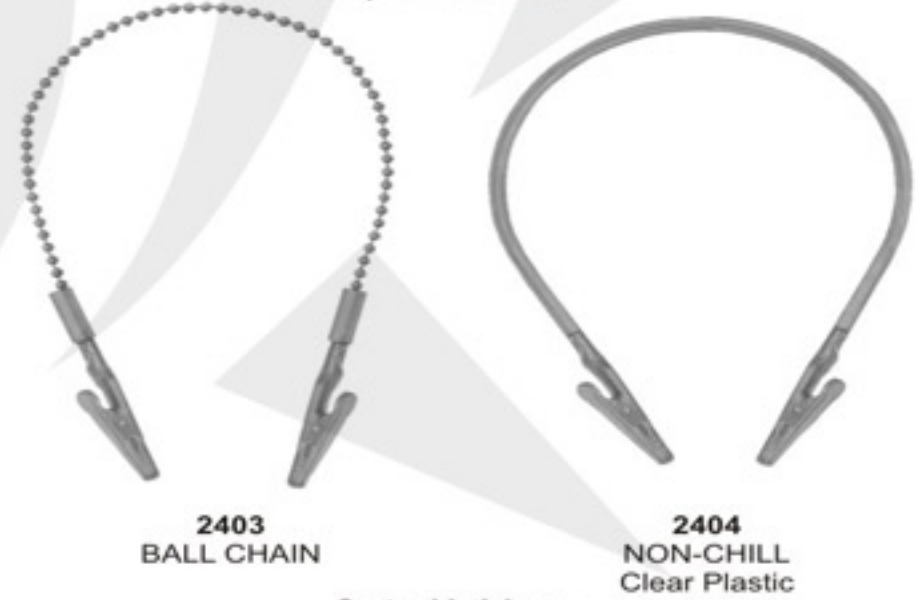

2401
X-Ray Holder
Small



Set of 10
2402
Film Hanger

Strip Holders

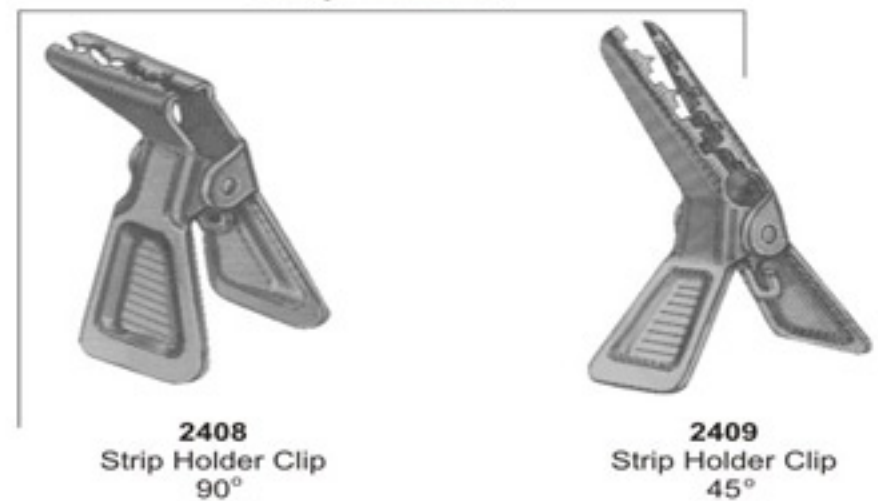

2405
Finger Protector
Small



2406
Medium



2407
Large





Rubber Dam Instruments



2410
IRORY
Light weight, 170 mm



2411
BREWER
175 mm



2412
BREWER
175 mm



2413
WHITE
175 mm



2414
IVORY
170 mm



2415
AINSWORTH
Rubber Dam Punch
170 mm



2416
AINSWORTH
Ainsworth
Rubber Dam Punch
170 mm



2417
AINSWORTH
Rubber Dam Punch
170 mm

Articulating Paper Forceps



2421
MILLER
Articulating
Forceps
15 cm

2422
MILLER
Articulating
Forceps
15 cm



2418
"IV" Type
Rubber Dam Punch
160 mm



2419
Plastic Rubber Dam
Frame 242



2420
Rubber Dam Holder
Stainless Steel Pins



Rubber Dam Instruments

LOWER MOLARS



2423
76D-W3

2424
76D-3



2429
76D-7A

2430
76D-7



2435
76D-12A

2436
76D-13A



2441
76D-26

2442
76D-28



2445
76D-W8A

2446
76D-8A



2447
76D-10

2448
76D-11



2451
76D-24

2452
76D-25

UPPER MOLARS



2425
76D-4

2426
76D-5



2431
76D-8

2432
76D-26N



2437
76D-30

2438
76D-31



2443
76D-201

2444
205

MOLARS



2449
76D-14

2450
76D-118



2453
76D-27

2454
76D-56

PREMOLARS



2427
76D-0

2428
76D-1



2433
76D-2A

2434
76D-2



2439
76D-27N

2440
76D-29

ANTERIOR



2456
76D-00

2457
76D-1A

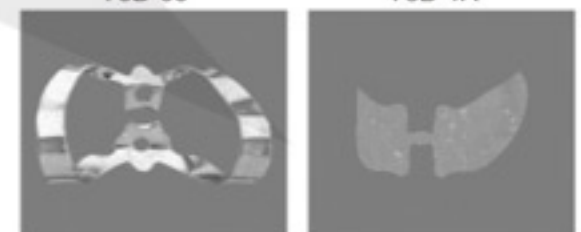

2458
76D-9

2459
76D-212



Aspirating Syringes

4969/CO



4969/F



4969/CV

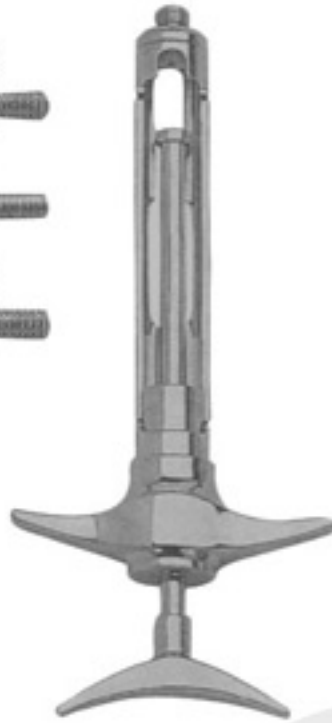

2460
ml 1,8
EU



2461
ml 1,8
EU/AM



2462
ml 1,8
EU/AM



2463
Fig. 1
ml 1,8
EU



2464
Fig. 1
ml 1,8
EU



2465
SS INOX
All inox & autoclavable
black plastic handle
passive automatic
aspiration.

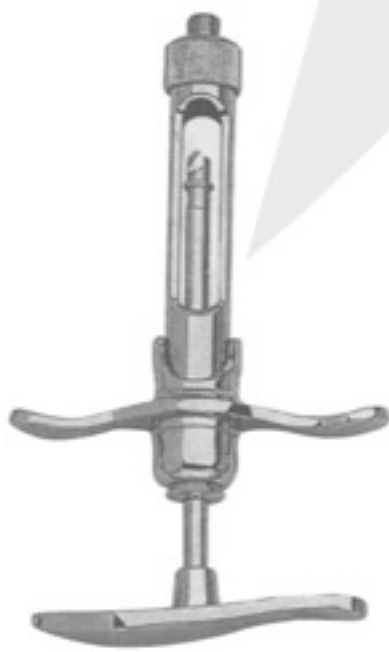

2466
Fig. 1
ml 1,8
EU/Am



2467
Fig. 1
ml 1,8
EU/Am



2468
Fig. 1
ml 1,8
EU/Am



2469
ml 1,2
EU/Am



Syringes

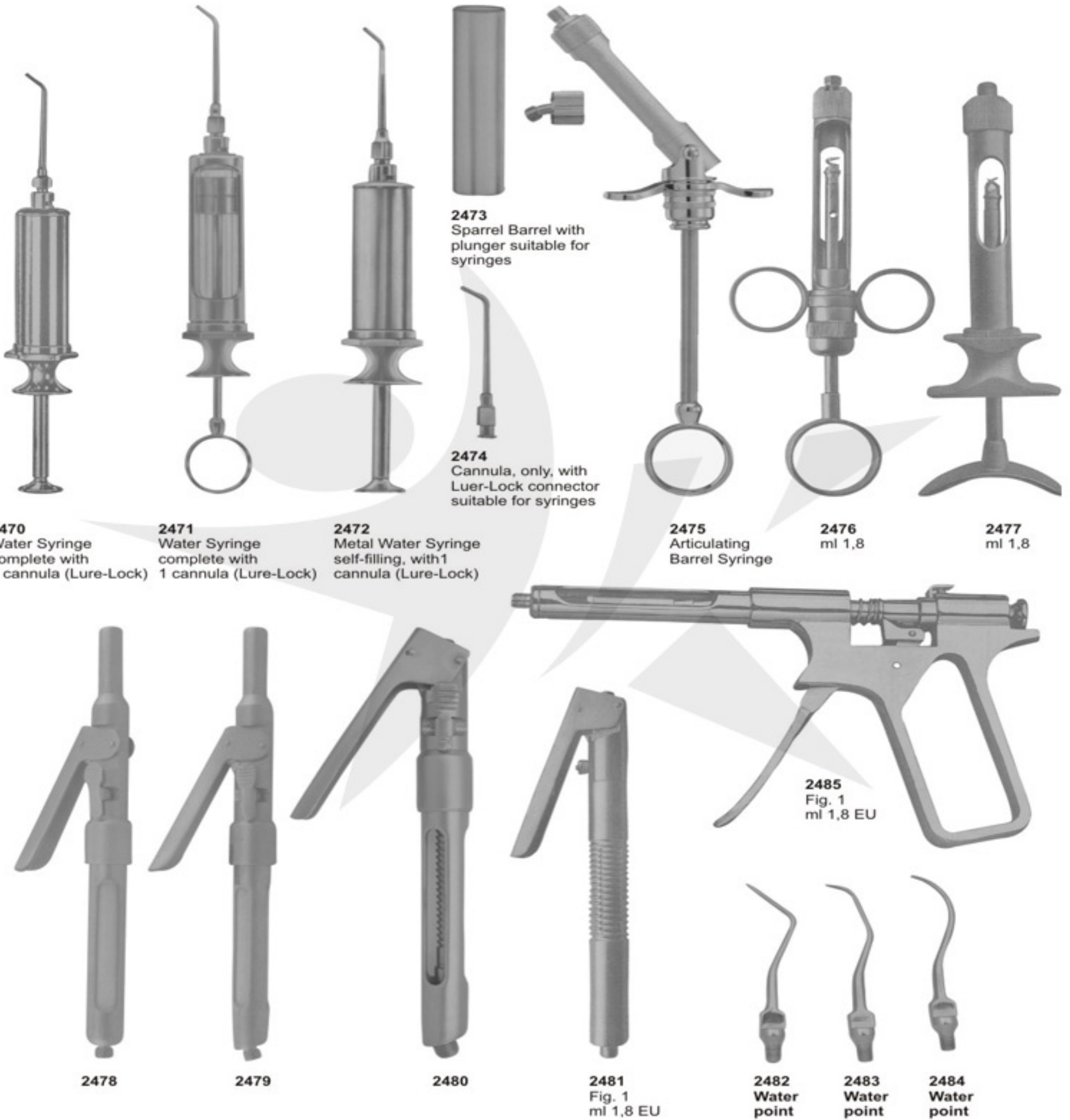

2470
Water Syringe
complete with
1 cannula (Lure-Lock)

2471
Water Syringe
complete with
1 cannula (Lure-Lock)

2472
Metal Water Syringe
self-filling, with 1
cannula (Lure-Lock)

2473
Sparrel Barrel with
plunger suitable for
syringes

2474
Cannula, only, with
Luer-Lock connector
suitable for syringes

2475
Articulating
Barrel Syringe

2476
ml 1,8

2477
ml 1,8

2485
Fig. 1
ml 1,8 EU

2478

2479

2480

2481
Fig. 1
ml 1,8 EU

2482
Water
point

2483
Water
point

2484
Water
point



Dental Tweezers

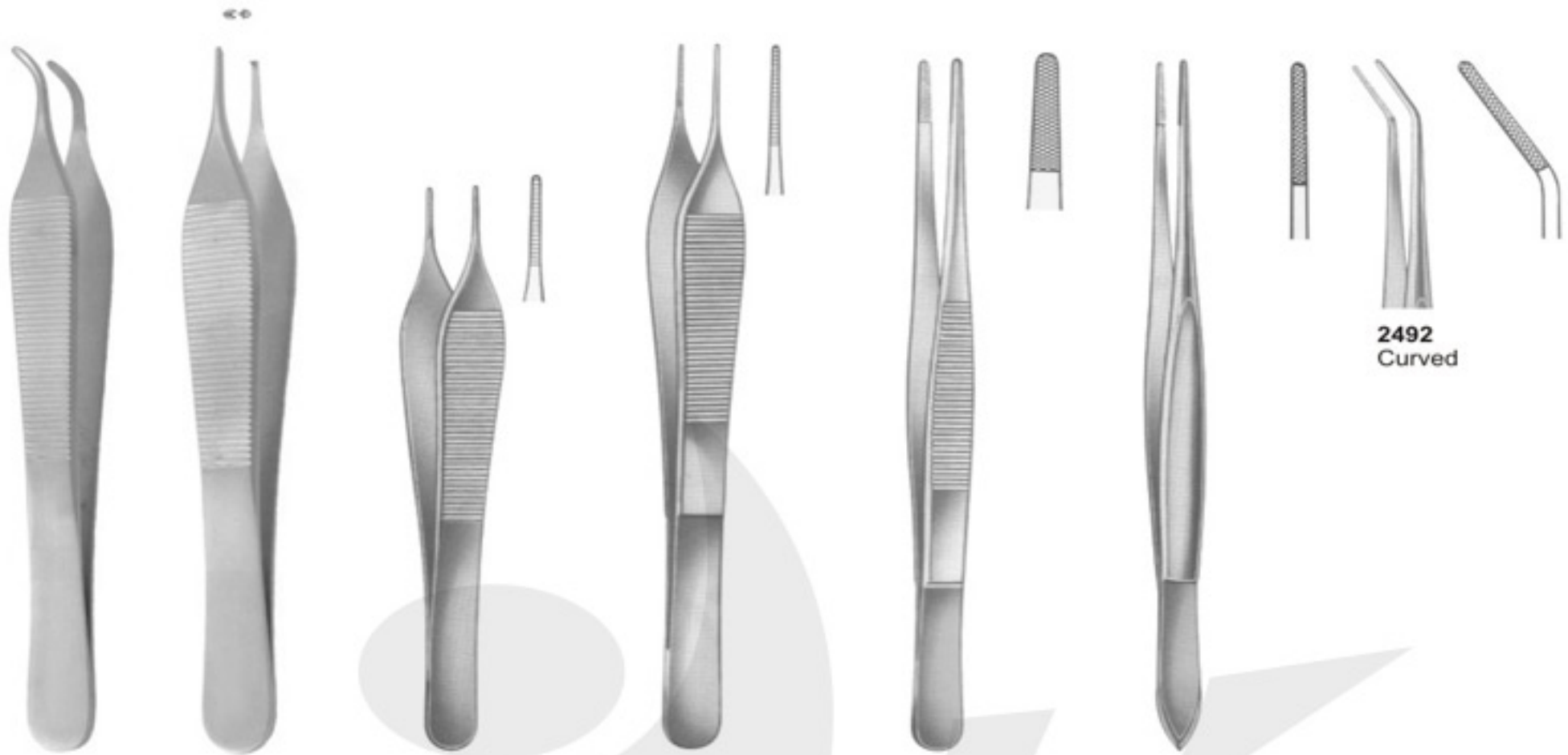

2486
ADSON
Curved 14 cm

2487
ADSON
1X2 / 12 cm

2488
ADSON
12 cm

2489
MICRO ADSON
15 cm

2490
STANDARD
14,18,25 cm

2491
CUSHING
18 cm

2492
Curved

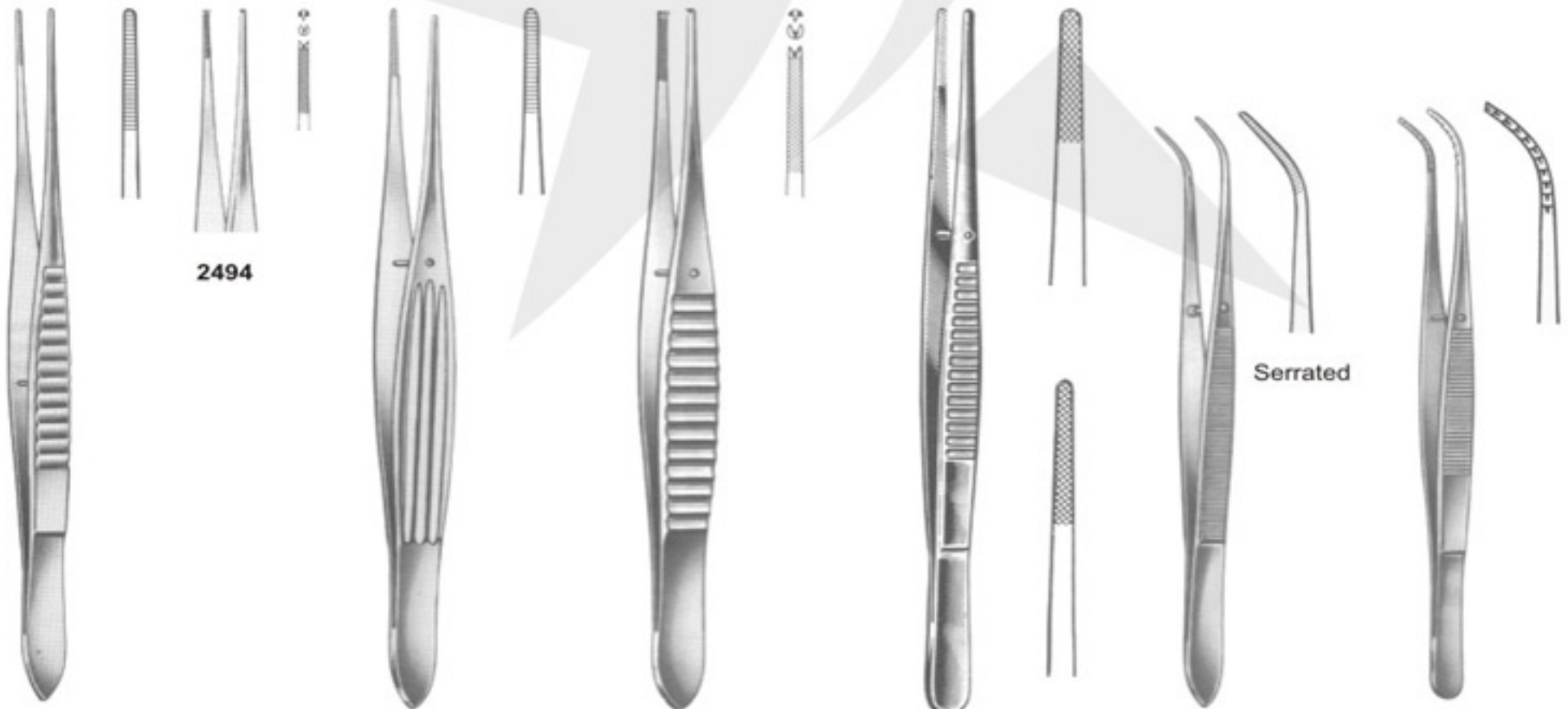

2493
SELECT
15,18,20 cm

2494

2495
MCINDOE
15 cm

2496
GILLIES
15 cm

2497
WAUGH
15,20 cm

Serrated

2498
PERRY
13 cm

2499
KOPP
15.5 cm



Dental Tweezers





Dental Tweezers



2508
MERIAM
16 cm



smooth



2509
MERIAM
16 cm



serrated



2510
MERIAM
16 cm



smooth



2511
MERIAM
16 cm1



serrated



2512
MERIAM
16 cm



smooth



2513
MERIAM
16 cm



serrated



2514
MERIAM
16 cm



smooth



2515
MERIAM
16 cm



serrated



Dental Tweezers

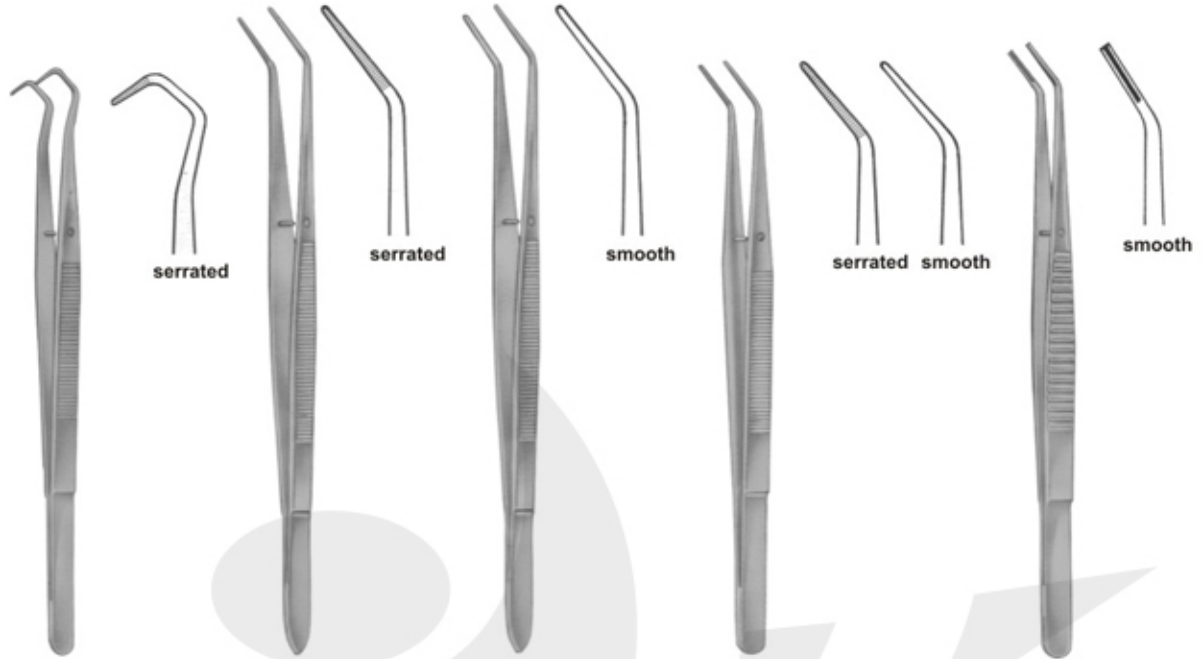

2516
COLLEGE
14.5 cm, 5³/₄"

2517
FLAGG
16 cm, 6¹/₄"

2518
FLAGG
16 cm, 6¹/₄"

2519
LANDGRAF
15 cm, 6"

2520
15.5 cm, 6¹/₈"

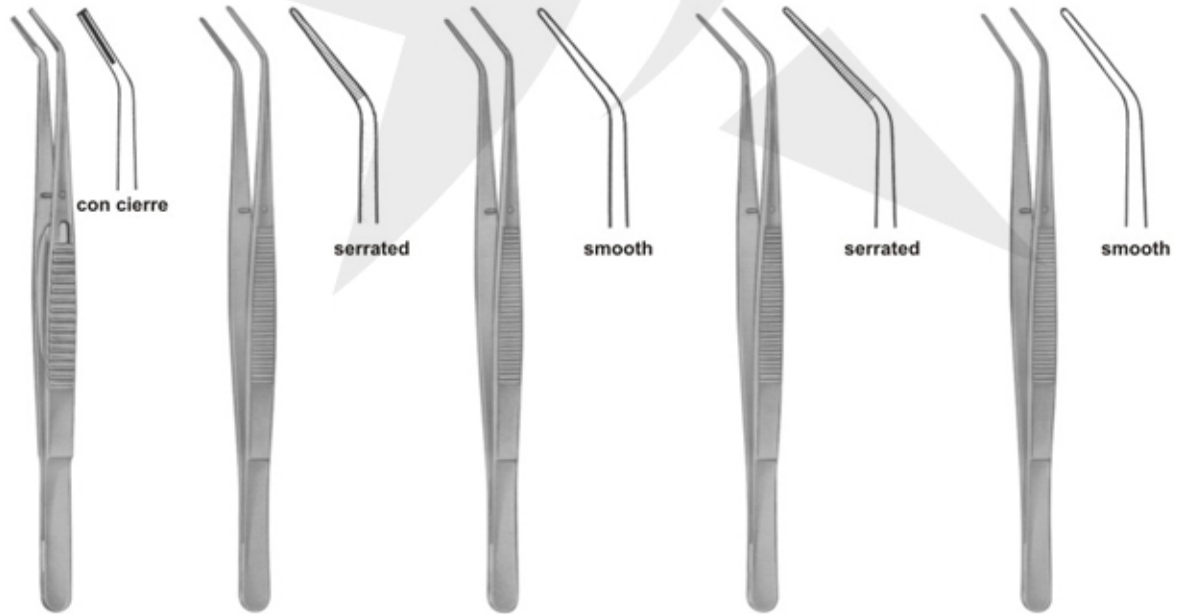

2521
15.5 cm, 6¹/₈"

2522
LONDON-COLLEGE
15 cm, 6"

2523
LONDON-COLLEGE
15 cm, 6"

2524
LONDON-COLLEGE
15 cm, 6"

2525
LONDON-COLLEGE
15 cm, 6"



Dental Tweezers



2526
LONDON-COLLEGE
15 cm, 6"



2527
LONDON-COLLEGE
15 cm, 6"



con cierre



2528
MERIAM
16 cm, 6 1/4"



serrated



smooth



2529
ALLEN
18 cm, 7 1/8"



2530
ALBRECHT
16 cm, 6 1/4"



2531
ALBRECHT
16 cm, 6 1/4"



2532
16 cm, 6 1/4"



2533
16 cm, 6 1/4"



2534
16 cm, 6 1/4"





Sterilizing & Lab Instruments



2535
DAVIS
6"



2536
Grasping Forceps
6 1/4"



2537
Mesh Bur & Diamond Holder
Large, 2 1/8" Diameter



2538
Soldering Tweezers
6 1/4"



2539
Narrow Fine
4 3/4"



2540
Super Fine
4 3/8"



2541
Fine Curved
4 1/2"



2542
Bonding Bracket
Holder
136 mm



2543
Bonding Bracket
Holder
135 mm



2544
Bonding Bracket
Holder
135 mm



2545
Bonding Bracket
Holder
140 mm



Endodontic Forceps



2546
Endo Forceps
4 3/4"



2547
PEETS Forceps
4 3/4", Useful For
Removing Broken
Instruments

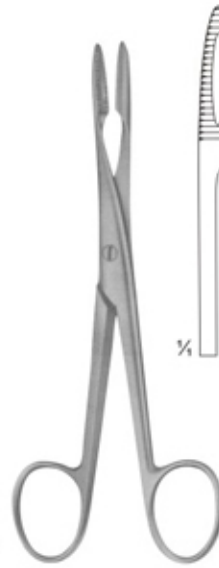

2548
Without Ratchet
145 mm

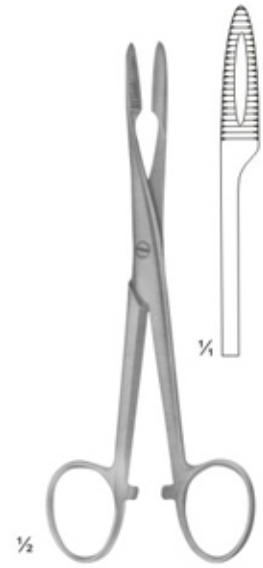

2549
With Ratchet
145 mm

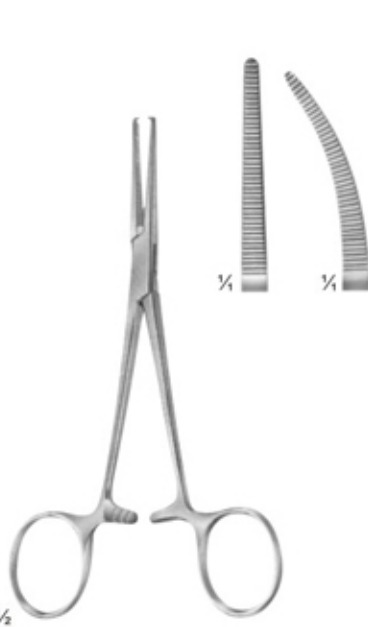

2550
CRILE
140 mm

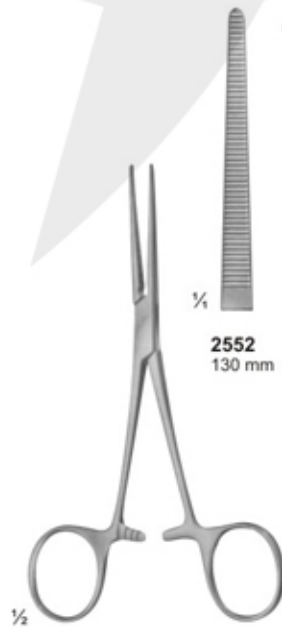

2551
PEAN
Slender type

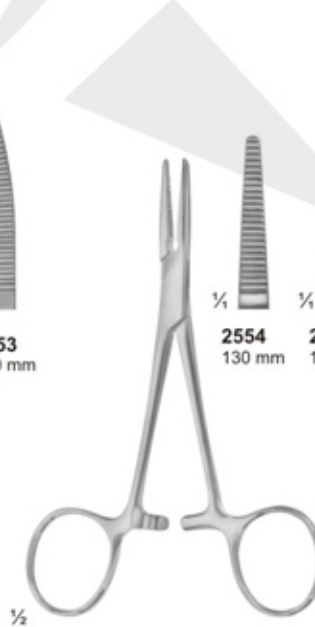

2554
SPENCER-WELLS

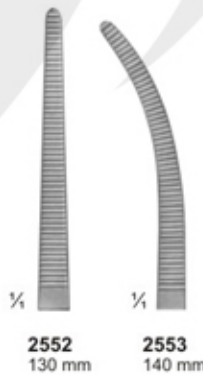

2552
130 mm

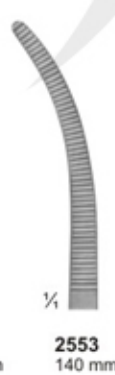

2553
140 mm

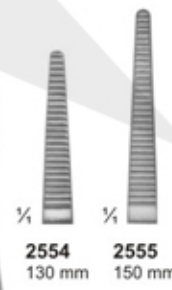

2554
130 mm

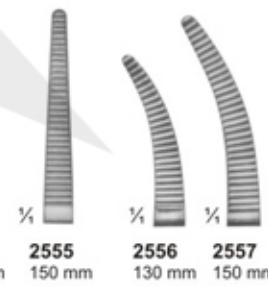

2555
150 mm

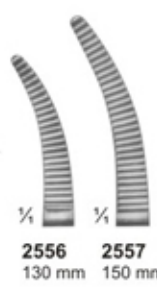

2556
130 mm



2557
150 mm



Tissue Forceps



2558
BABY-ALLIS
5", Straight
4x5 teeth extra delicate

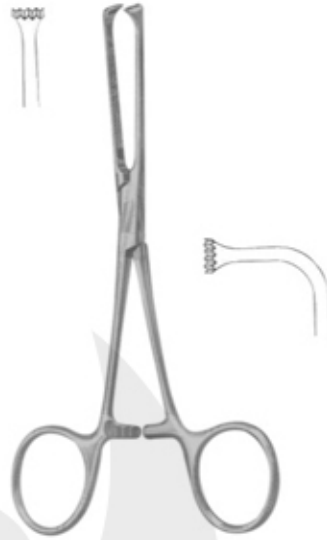

2559
ALLIS
6", Straight
4x5 teeth extra delicate

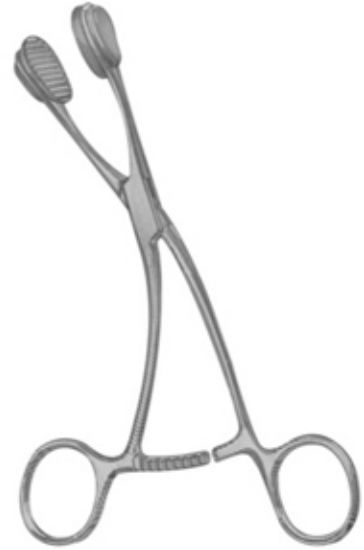

2560
ALLIS
6", Straight
4x5 teeth extra delicate



2561
1x2 teeth
6"



2562
SEMKIN
6", Straight,
1x2 teeth



2563
ADSON
4 3/4"
1x2 teeth



2564
BROWN-ADSON
4 3/4"
7x7 teeth



2565
BROWN
6"
8x8 teeth



2566
RUSSIAN
6"
8x8 teeth



2567
Extra-Delicate,
Straight, 4"
1x2 teeth



Retractors, Depressors, Mouth Gags



2576
DENHART



2577
DENHART
Mouth Gag With
Silicon Inserts,
Interchangeable
Size: 125 mm

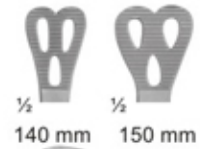

2578
WIEDER
Tongue depressor
2579 140mm
2580 150mm

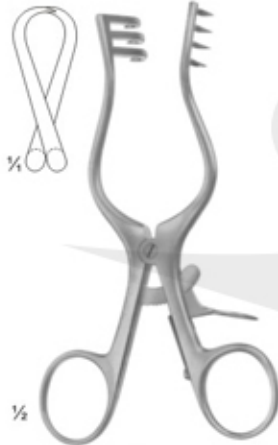

2583
WEITLANER
Sharp
130 mm

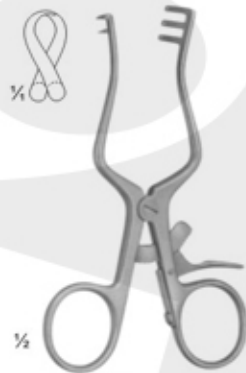

2584
WEITLANER
Sharp
110 mm

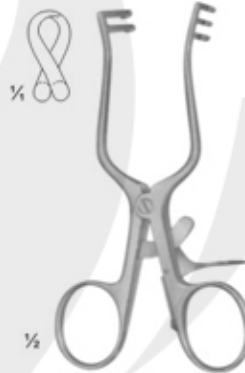

2585
WEITLANER
Semi-Sharp
110 mm



2581
TOBOLD
Tongue depressor
Size: 145 mm

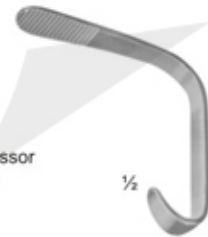

2582
ANDREW
Tongue depressor
Size: 110 mm



2586
MOLT
Pediatric



2587
MOLT
Child



2588
MOLT
Adult



2589
FERGUSSON-ACKLAND
Mouth Gag
Size: 145 mm



2590
ROSER KOENIG
Mouth Gag
Size: 160mm / 185mm



Lip & Cheek Retractors

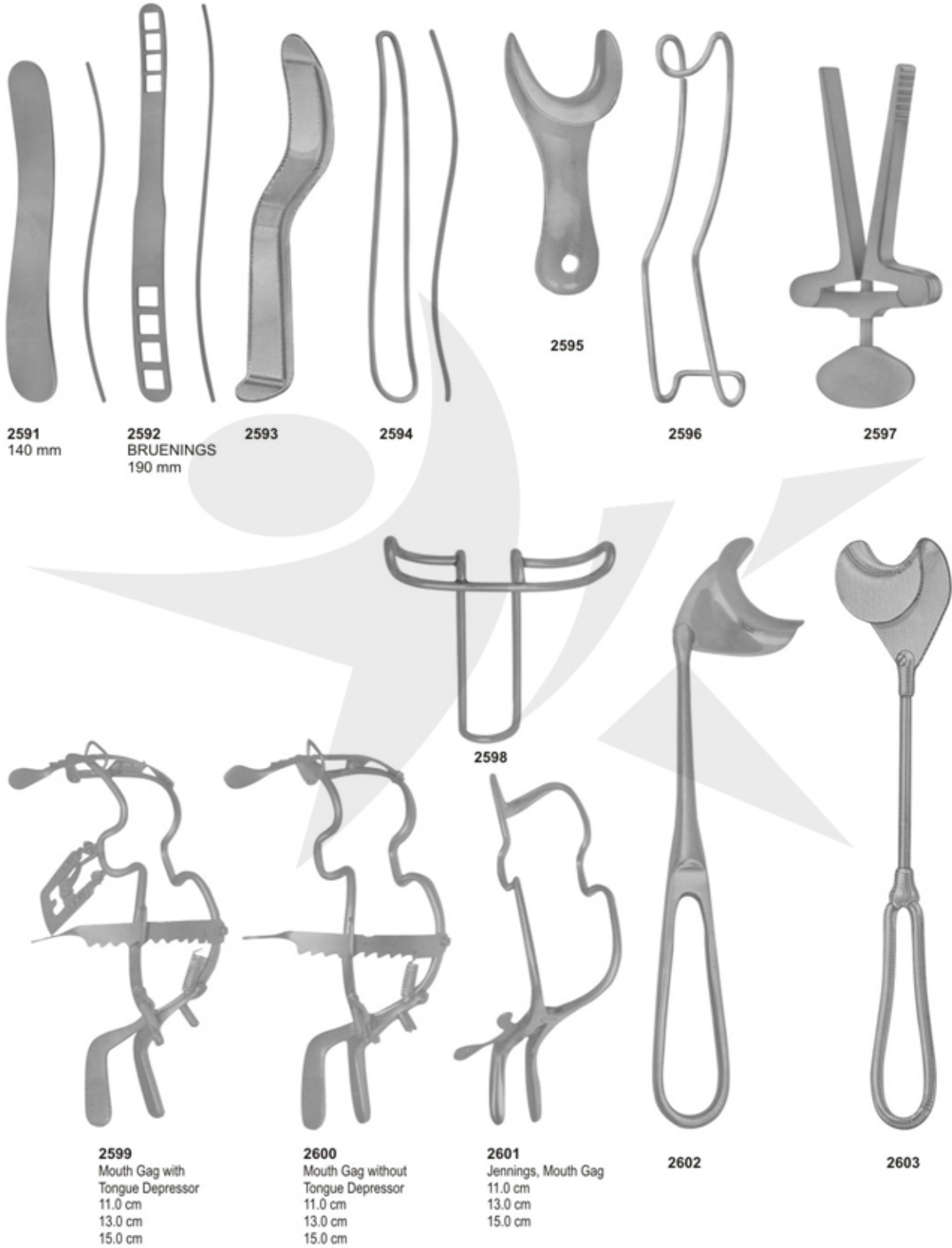



Lip & Cheek Retractors

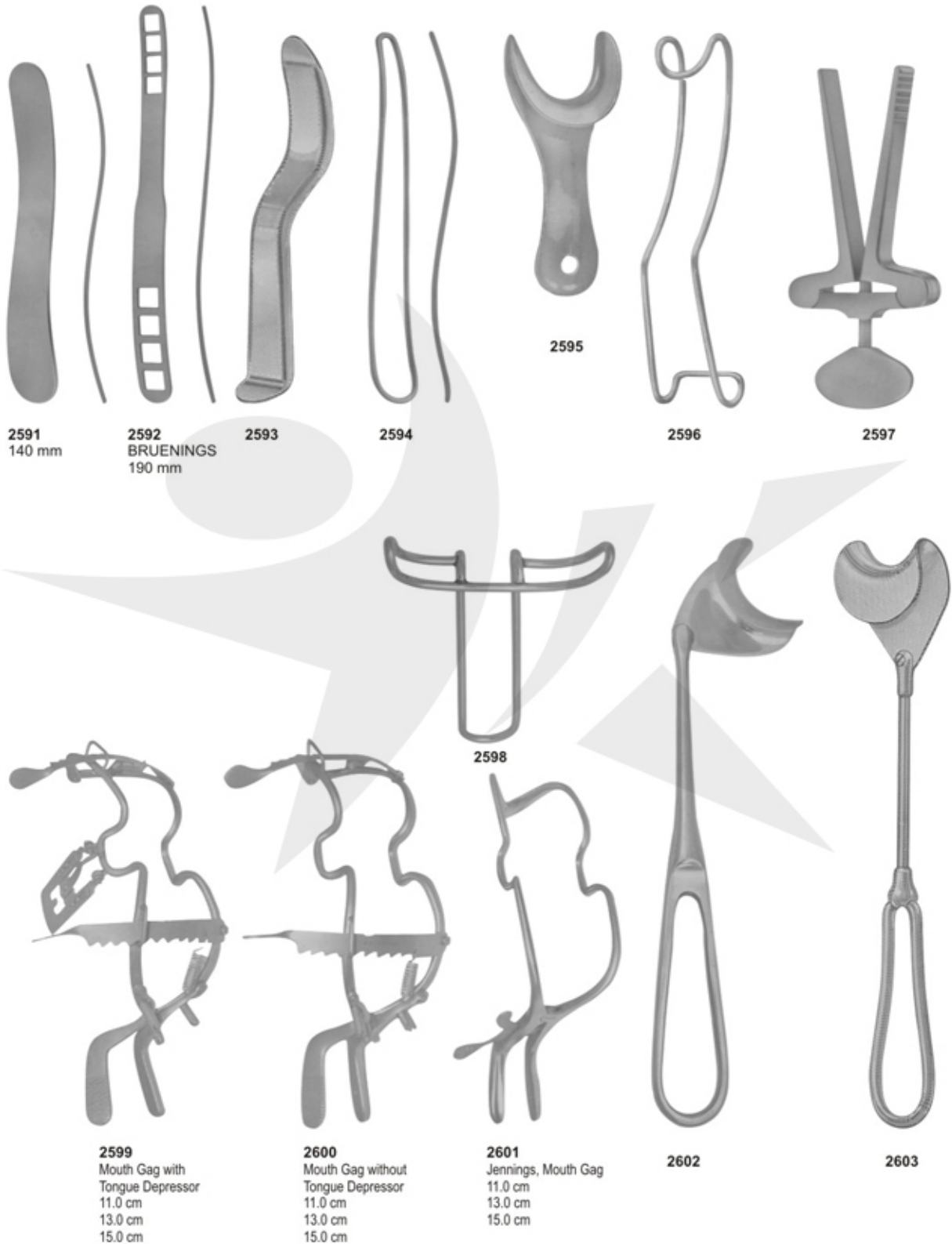



Lip & Cheek Retractors

30 x 4 mm A
23 x 7 mm B
24 x 11 mm C
29 x 10 mm D
30 x 11 mm E
32 x 14 mm F
40 x 11 mm G
42 x 10 mm H
50 x 11 mm I
55 x 11 mm J
60 x 11 mm K
70 x 11 mm L
70 x 14 mm M

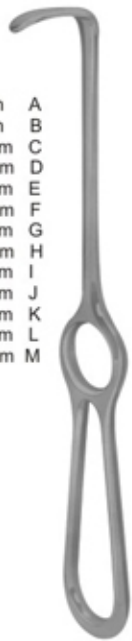

2604
LANGENBECK
210 mm



2605
KOCHER-LANGENBECK
215 mm



2606
BUCHS
205 mm



38 x 18 mm



2607
KOCHER
230 mm



2608
MIDDELDORPF



2609
15 x 15 mm
220 mm



2610
20 x 22 mm
215 mm



2611
28 x 28 mm
235 mm



2612
KOCHER
230 mm



2613
COLLIN
150 mm



2614
ROUX
Set
165 mm



Sterilizing Forceps



2615
Sterilizing Forcep Curved
20 cm A
25 cm B
30 cm C

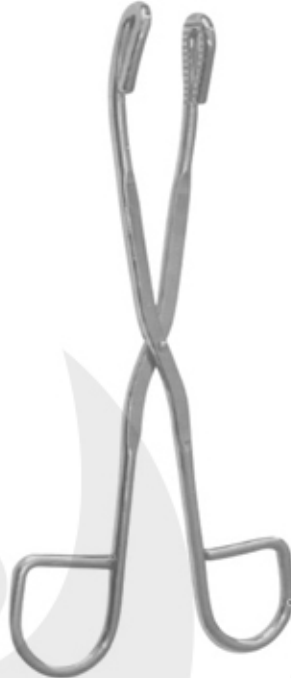

2616
Sterilizing Forcep Straight
20 cm A
25 cm B
30 cm C



2617
Sterilizing Forcep
30 cm



2618
Becht Tweezer



2619
Sterilizing Forcep
23 cm A
30 cm B



2620
Sterilizing Forcep
20 cm



Tissue Retractors & Hooks



2621
3 sharp prongs



2622
2 sharp prongs
6"



2623
2 sharp prongs
6"



2624
FOMON
145 mm



2625
ALM
70 mm



2626
SENN
3 sharp prongs
6 3/8"



2627
TOENNIS
Dura Retractor
150mm



2628
JOSEPH
165 mm

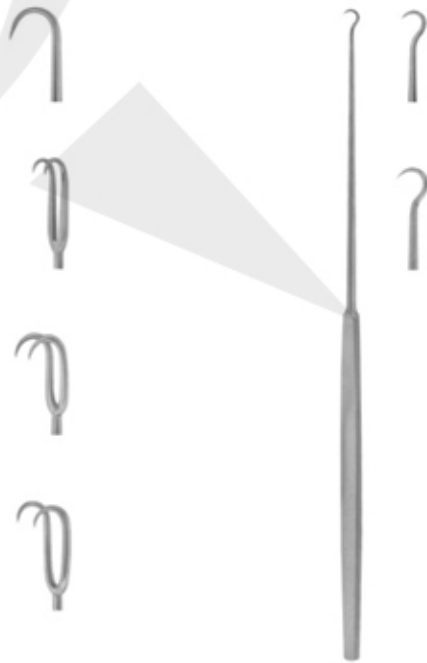

2629
GILLIES
180 mm



Orthodontic Pliers



2630
Light Wire Cutter



2631
Wire Cutter



2632
Posterior Band Remover
Long



2633
Posterior Band Remover
Short



2634
Jarabak Plier



2635
Distal End Cutter
Safety End Cutter



2636
Distal End Cutter



2637
Kim's Plier



2638
Loop Forming Plier



2639
Tweed Arch Bending Plier



2640
Utility Plier



2641
Bonding Bracket Remover



2642
Lingual Arch Plier



2643
Light Wire Plier



2644
Wire Cutter
12.5 cm



Orthodontic Pliers



2645
Fig. 101
Wire Bending

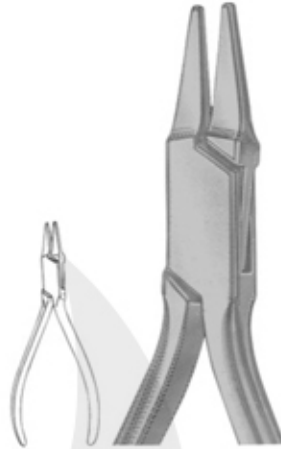

2646
Fig. 118
PEESO
Collar



2647
Fig. 417
Crown Shell

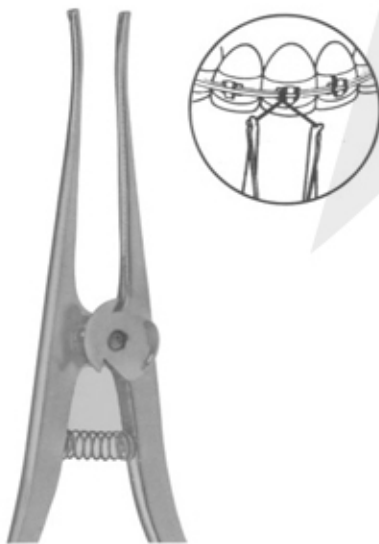

2648
STEINER
150 mm
Ligature Pliers

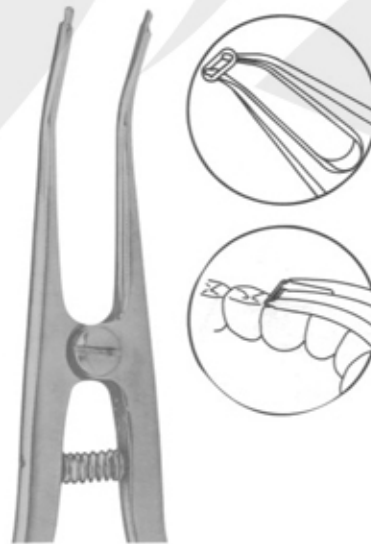

2649
Separating Pliers Elastics
150 mm

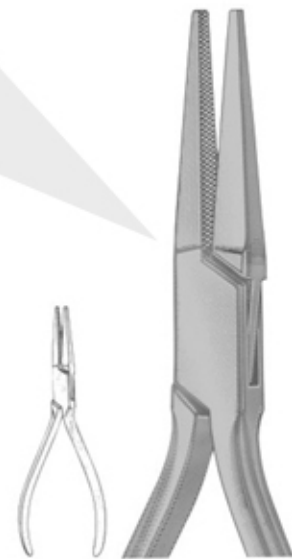

2650
121-Lab & Office



Orthodontic Pliers



2651
How Plier-Titanium Alloy
With special coated beaks

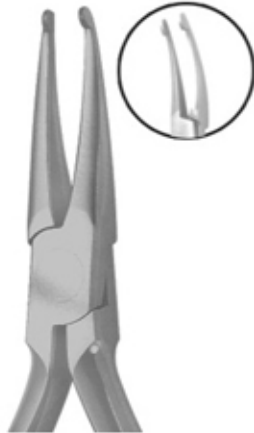

2652
How Plier
Tips are 1/8"(3.2mm)
diameter



2653
How Plier
Tips are 1/8"(3.2mm)
diameter



2654
How Plier-Small
Tips are 3/32"(2.4mm)
diameter



2655
How Plier-Offset
Tips are 1/8"(3.2mm)
diameter



2656
Weingart Utility Plier
-Titanium Alloy
with special coated beaks



2657
Weingart Utility Plier
New type of the Weingart Utility Plier
designed for a more precise operation.

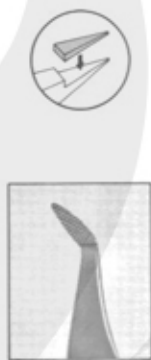

2658
Weingart Utility Plier

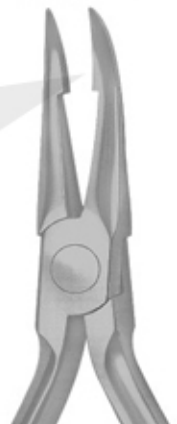

2659
Weingart Utility Plier

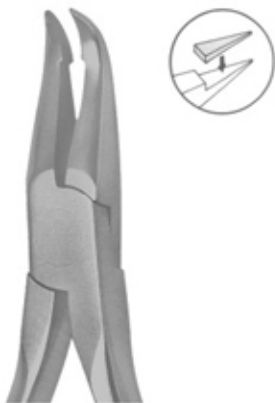

2660
Weingart Utility Plier



2661
Bird Beak Plier With Cutter
**Maximum Bending &
Cutting Capacity:**
Wires up to .032"

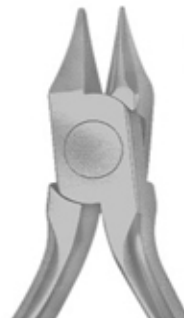

2662
Bird Beak Plier
Maximum Bending Capacity:
Wires up to .032"



2663
Bird Beak Plier
**Maximum Bending
Capacity:**
Wires up to .030"



Orthodontic Pliers



2664
TWEED (Fig. 98)
13 cm, 5 1/8"
Tweed Loop Omega Pliers.



2665
TWEED - (Fig. 90)
14 cm, 5 1/2"

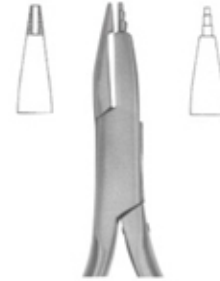

2666
O'BRIEN - (Fig. 97)
14 cm, 5 1/2"



2667
TWEED (Fig. 96)
14 cm, 5 1/2"



2668
TWEED (Fig. 95)
13.5 cm, 5 1/4"

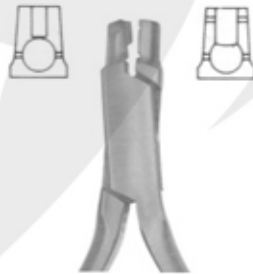

2669
SCHWARZ (Fig. 29)
12.5 cm, 5"



2670
NANCE (Fig. 80)
13 cm, 5 1/8"

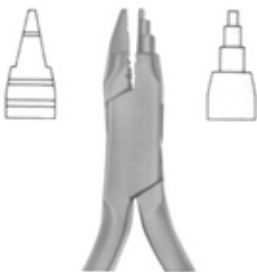

2671
YOUNG (Fig. 55)
13 cm, 5 1/8"



2672
SCHWARZ (Fig. 30)
13 cm, 5 1/8"

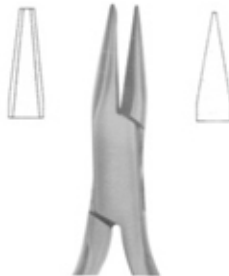

2673
Optical Plier (Fig. 53)
14 cm, 5 1/2"

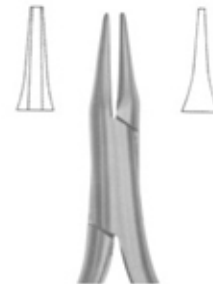

2674
Schwarz (Fig. 79)
13.5 cm, 5 1/4"



Orthodontic Pliers



2675
NANCE (Fig. 56)
12.5 cm, 5"
Wire bending Pliers

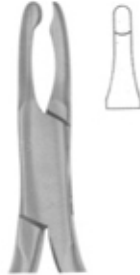

2676
JOHNSON (Fig. 59)
13.5 cm, 5 1/4"
Contouring Plier.

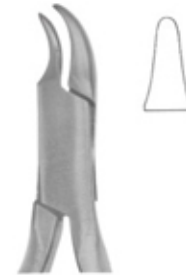

2677
REYNOLDS (Fig. 61)
13 cm, 5 1/8"
Contouring Plier.



2678
De La Rosa (Fig. 34)
12.5 cm, 5"
Contouring Plier, Non-Grooved



2679
De La Rosa (Fig. 35)
12.5 cm, 5"
Contouring Plier, Grooved



2680
14.0 cm
Goslee Contouring Plier



2681
14.0 cm
Goslee Contouring Plier



2682



2683
Fig. 58
12.5 cm, 5"
Lingual Arch Bending Plier



2684
Frevert/Tweed (Fig. 51)
12.5 cm, 5"
Tweed Arch Plier/Standard Jaw

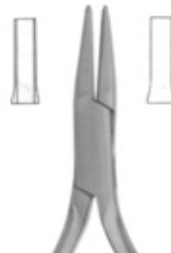

2685



2686
ANGLE (Fig. 52)
13 cm, 5 1/8"
Arch Forming Plier



Orthodontic Pliers



2687
Fig. 60
13 cm, 5 1/8"
Wire & Clasp Bending Pliers



2688
Fig. 60
13 cm, 5 1/8"
Wire & Clasp Bending Pliers

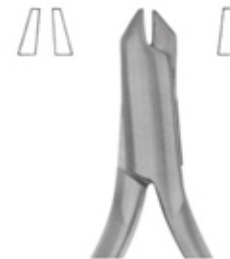

2689
Aderer (Fig. 57)
12 cm, 4 3/4"
Wire & Clasp Bending Pliers



2690
49 e 49 TC
14 cm, 5 1/2"
Band Removing Plier, short pad



2691
50 e 50 TC
14 cm, 5 1/2"
Band Removing Plier, long pad



2692
Fig. 84
14.5 cm, 5 3/4"
Band pinshing & ligature
locking plier, serrated



2693
Fig. 72
14 cm, 5 1/2"
Band pinshing & ligature
locking plier, serrated



2694
BRACKET (Fig. 82)
13.5 cm, 5 1/4"
Direct Bonding Bracket Remover



2695
BRACKET (Fig. 83)
13.5 cm, 5 1/4"
Direct Bonding
Bracket Remover



Orthodontic Pliers

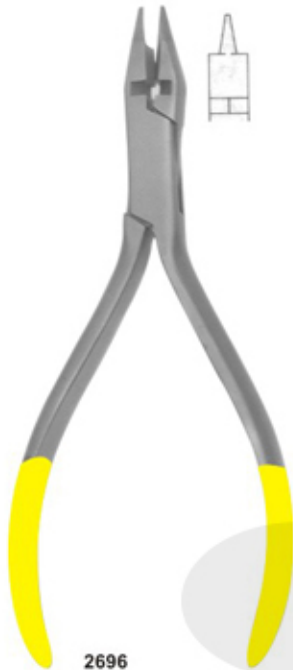

2696
38c, 38TC
13.5 cm, 5 1/4"
Contouring closing loop pliers,
wire bending, cutter.

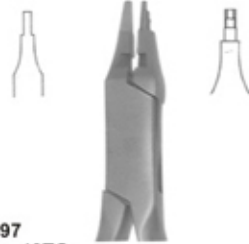

2697
40c, 40TC
13.5 cm, 5 1/4"
Contouring pliers light wire pliers
grooved with cutter.

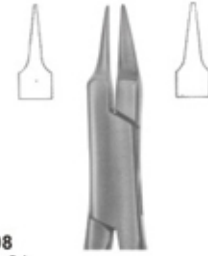

2698
Fig. 81
12.5 cm, 5"
Sling clasp & wire bending plier



2699
Fig. 28
14 cm, 5 1/2"
Sling clasp & wire bending plier.



2700
Fig. 21
13 cm, 5 1/8"
Light wires pliers, grooved



2704
46c - 46 TC
ADAMS - N. 139c
12.5 cm, 5"
Bird beak with cutter.



2701
ADAMS, 23, 23TC
12.5 cm, 5"
Sling clasp & wire bending plier.



2702
ADAMS (Fig. 33)
12.5 cm, 5"
For retaining elements.



2703
ADAMS (Fig. 44)
12.5 cm, 5"
Sling clasp & wire bending plier.



2705
Universal Wire Bending
Pliers (ADAMS) 47 TC, N.64
12.5 cm, 5"
Sling clasp & wire bending plier.



2706
86c, 86 TC
Angle Bird Beak - N.138
12.5 cm, 5"
Sling clasp & wire bending plier.



Orthodontic Cutters With T.C.



Ø 1.0 mm
(0.40")

2707
Fig. 18 TC
15 cm, 6"



Ø 1.0 mm
(0.40")

2708
Fig. 92 TC
14 cm, 5 1/2"



Ø 0.4 mm
(0.16")

2709
Fig. 91 TC
13 cm, 5 1/8"



Ø 0.4 mm
(0.16")

2710
Fig. 99 TC
13 cm, 5 1/8"



Ø 0.4 mm
(0.16")

2711
Fig. 94 TC
13 cm, 5 1/8"
Angled at 15° with or
without spring on \
the handles.



2712
Fig. 85 TC
13 cm, 5 1/8"



2713
Fig. 87 TC
13 cm, 5 1/8"



2714
Fig. 85 TC
Angled at 15°
13 cm, 5 1/8"



2715
ADAMS 87 TC
Angled at 15°
13 cm, 5 1/8"



Orthodontic Distal & Cutters

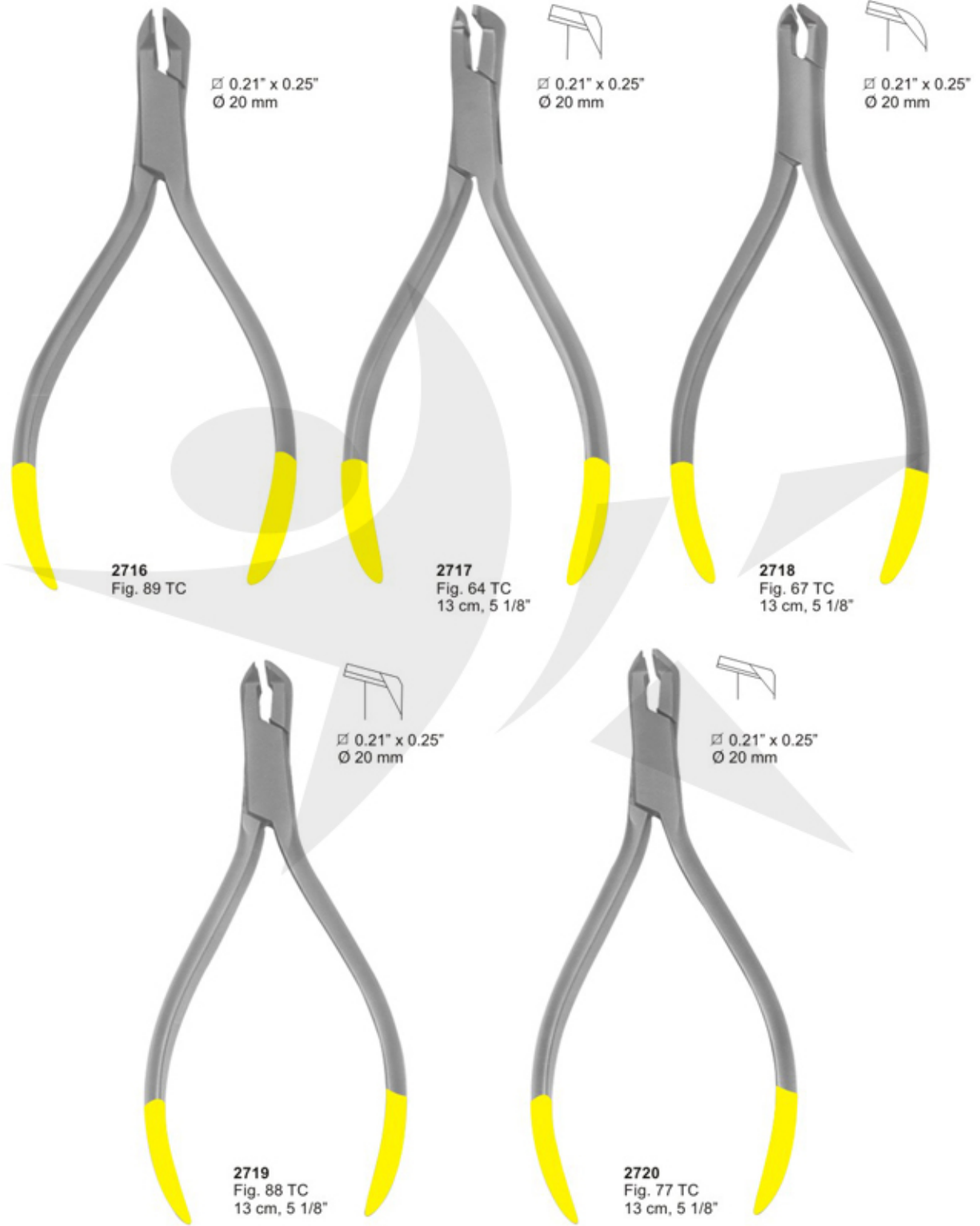



Pliers for Orthodontic & Prosthetics



2721
UNIVERSAL
150 mm

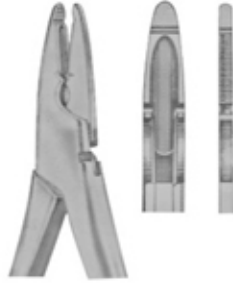

2722
WALDSACHS
155 mm



2723
ADERER
125 mm

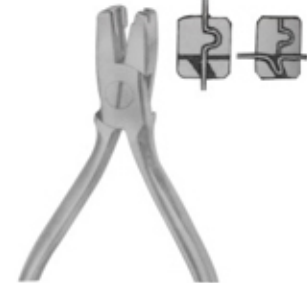

2724
NANCE
125 mm



2725
REYNOLDS
125 mm



2726
HOW
145 mm



2727
HOW
140 mm



2731
FURRER
150 mm

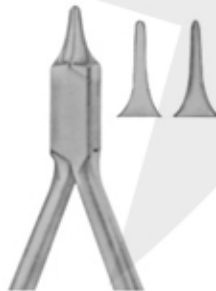

2728
WALDRON
125 mm



2729
ADAMS
125 mm



2730
ANGLE
125 mm



2732
YOUNG
130 mm



2733
NANCE
130 mm



Pliers for Orthodontic & Prosthetics



2734
LANGEBECK
125 mm



2735
LANGEBECK
140 mm



2736
LANGEBECK
130 mm

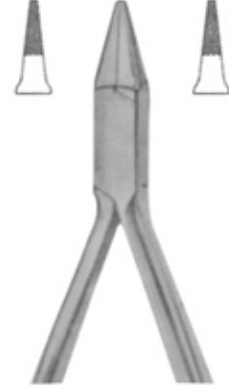

2737
PEESO
125 mm



2738
GOSLEE
125 mm

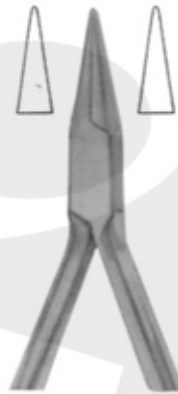

2739
FISCHER
140 mm



2740
FISCHER
140 mm

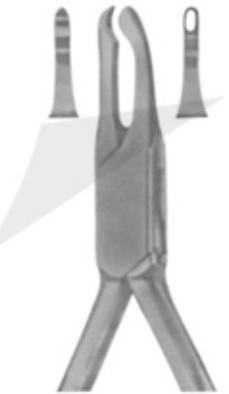

2741
JOHNSON
130 mm



2742
MSY
130 mm



2743
MC KELLOPS
155 mm



2744
ANDRESEN
130 mm



2745
SCHWARZ
130 mm



Rongeurs



2746
BLUMENTHAL
6", 30°, Standard

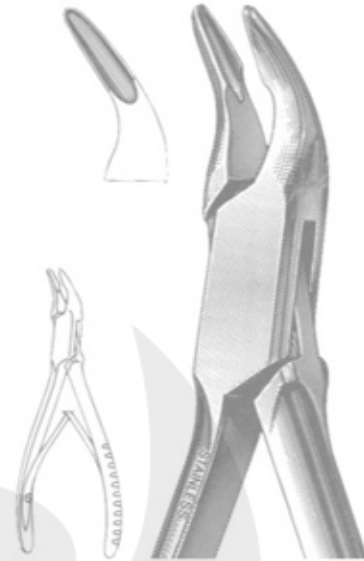

2747
MINI-BLUMENTHAL
6", 45°

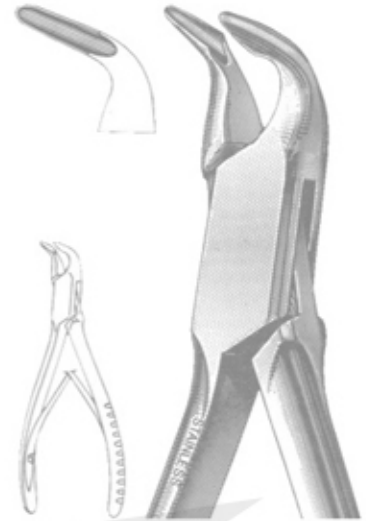

2748
MINI-BLUMENTHAL
6", 90°

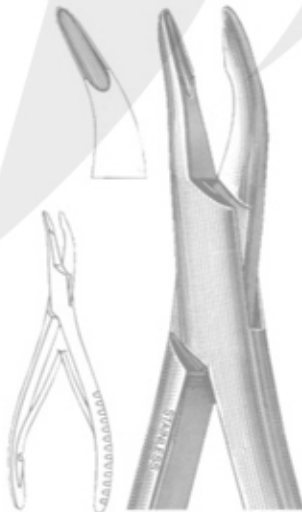

2749
BLUMENTHAL
7", 30°

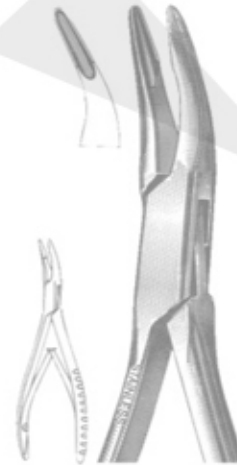

2750
MINI-BLUMENTHAL
4 1/2", 30°

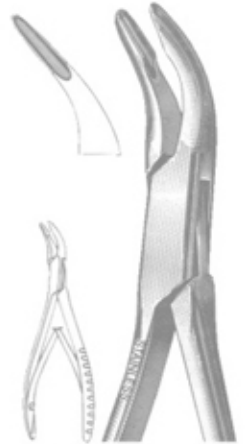

2751
MINI-BLUMENTHAL
4 1/2", 45°



Rongeurs



2752
CLEVELAND
No. 5-Side Cutting,
6 3/4"

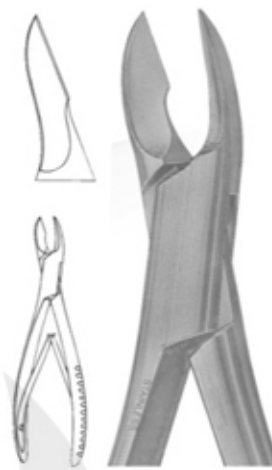

2753
CLEVELAND
No. 5A-Side Cutting,
6 1/2"

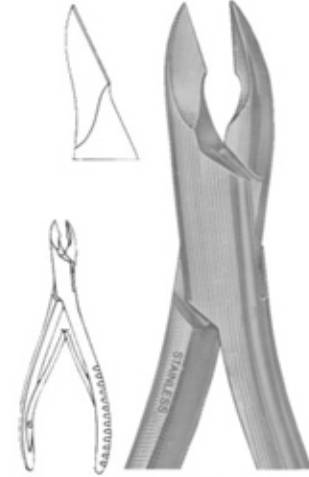

2754
CLEVELAND
No. 5S-Side Cutting,
6"



2755
No. 1A-MEAD
6 1/2"

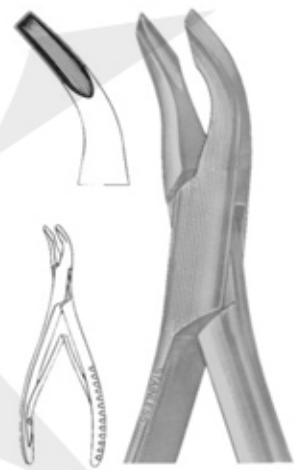

2756
MEAD, Square
No. 2A
Tips, 6 1/2"

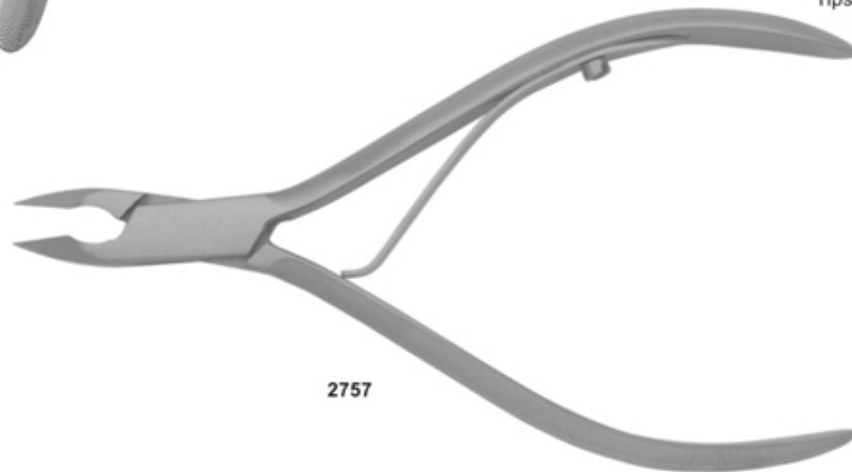

2757



Rongeurs



2757
FRIEDMAN
5 ½"

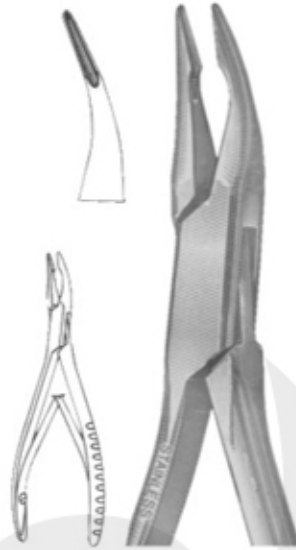

2758
MICRO-FRIEDMAN
5 ½", 15° Curved Jaws

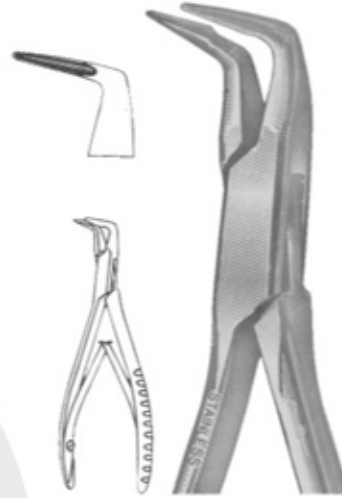

2759
MICRO-FRIEDMAN
Perio Rongeur, 5 ½"

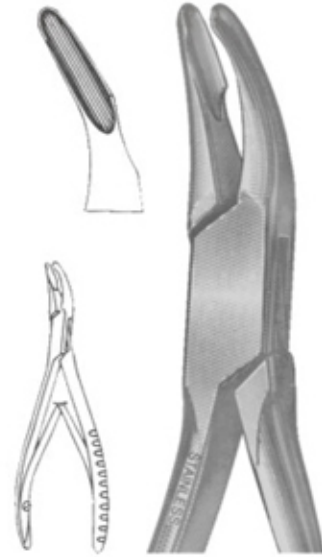

2760
CLEVELAND
No. 4 - 5 ½"

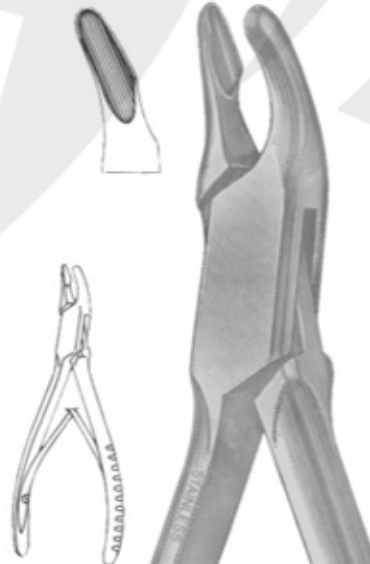

2761
CLEVELAND
No. 4A - 6 ½"

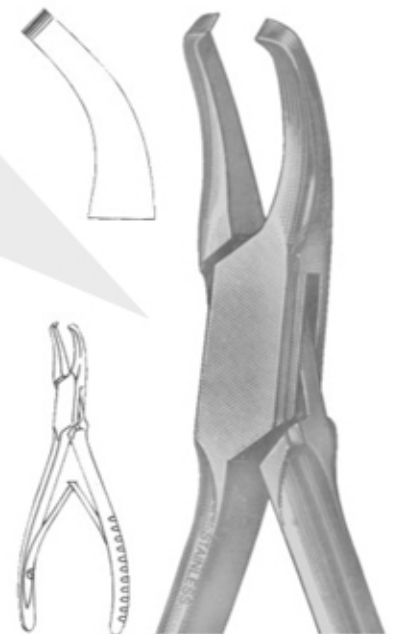

2762
GARDNER
No. 6A, End Cutting
6 ½"



Rongeurs



2763
BEYER
Double Action,
16,18 cm



2764
No. 1
6 1/2"

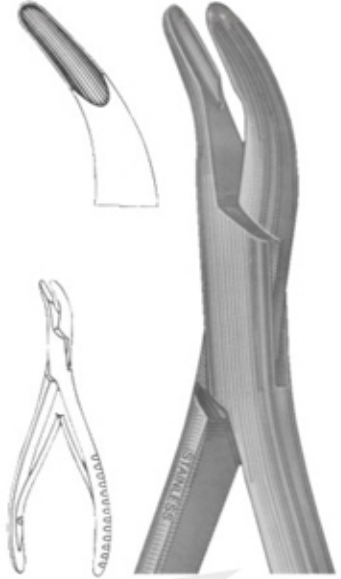

2765
HARTMAN
5 3/4"
Strong Curve

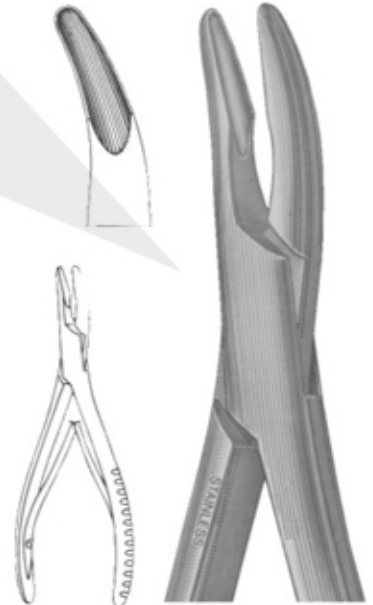

2766
BANE
Slight Curve
7"



Needle Holders



2767
COLLIER
5", Fenestrated Jaws



2768
DERF
4 3/4"



2769
WEBSTER
Delicate Smooth Jaws
5"



2770
NEIVERT
One Offset Ring
5"



2771
OLSEN-HEGAR
5 1/2"



2772
BAUMGARTNER
5 1/2"



2773
CRILE-WOOD
6"



2774
GARDNER
5"



Needle Holders

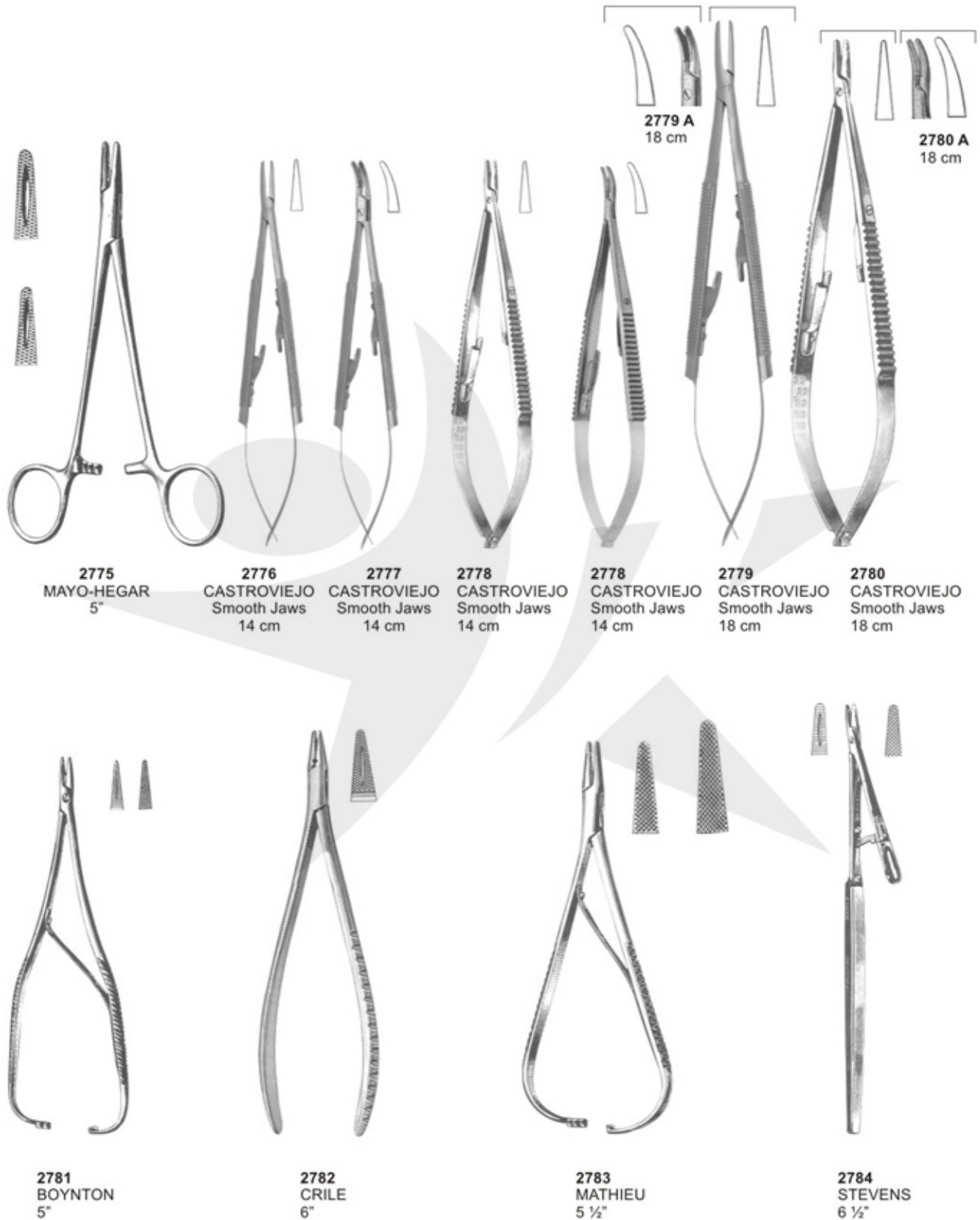



Micro Surgery Set



2785
Micro Scissor
Straight, 155 mm



2786
Micro Scissor
Straight, 150 mm



2787
Micro Scissor
Curved, 150 mm



2788
Micro Scissor
Curved, 155 mm



2789
CASTROVIEJO
T.C.
Straight, 180 mm



2790
Retractor
Fig.3
165 mm

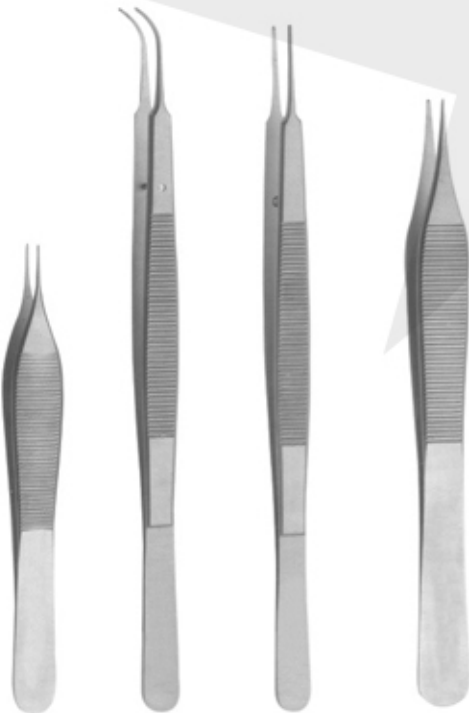

2791
Micro Adson
120 mm

2792
GERALD
Curved,
180 mm

2793
GERALD
Straight,
175 mm

2794
Micro Adson
160 mm

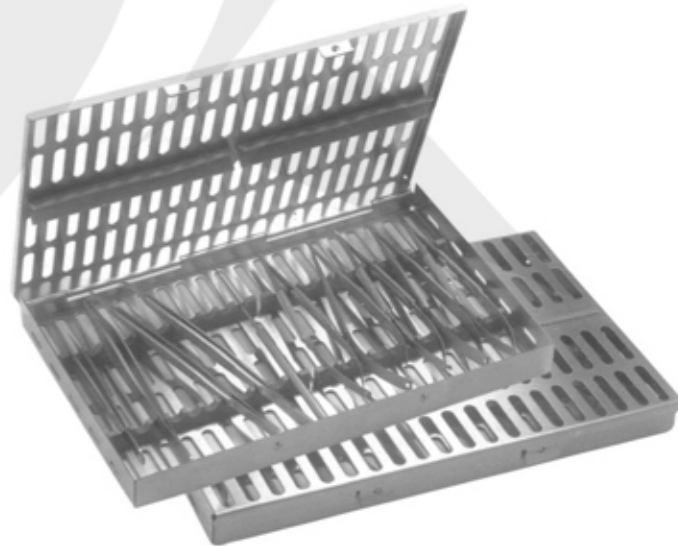

2795
Micro Surgery Set 10 Pieces.



Scissors



2796
IRIS (Standard)
Straight
11.5 cm, 4 1/2"

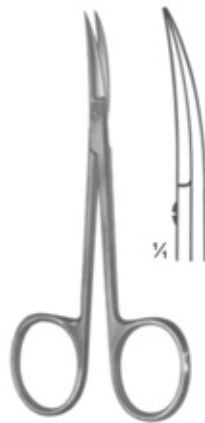

2797
IRIS (Standard)
Curved
11.5 cm, 4 1/2"



2798
STEVENS
Dissecting Scissors
Size: 115 mm



2799
Sharp



2800
Sharp



2801
Blunt



2802
Blunt



2803



2804
JOSEPH
Size: 150 mm

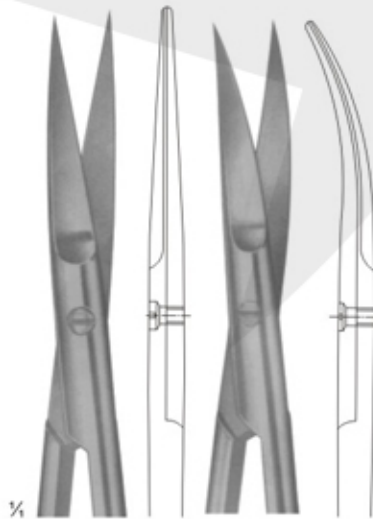

2805

2806

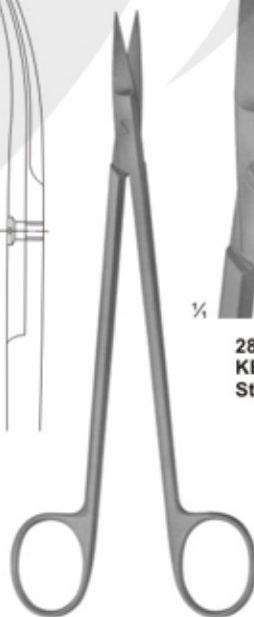

2807
KELLY
Size: 175 mm

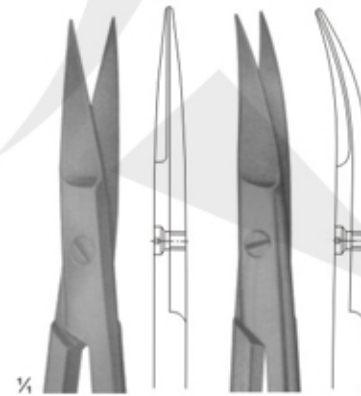

2808
KELLY
Straight



2809
KELLY
Curved

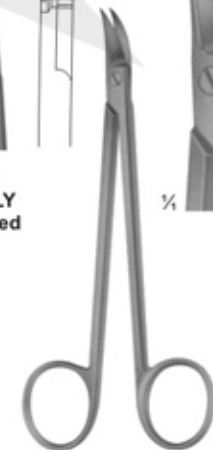

2810
QUINBY
Size: 130 mm



Scissors

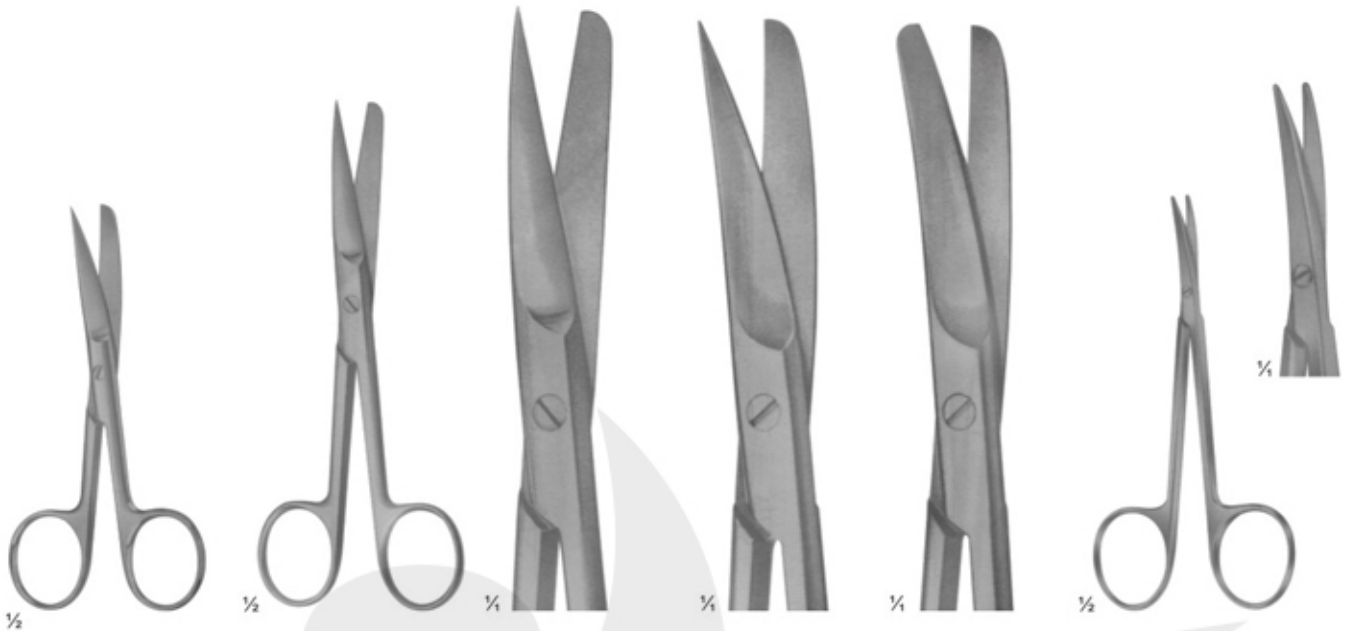

1/2
2811
Standard - Types
Size: 115 mm

1/2
2812
DEEVER
With flat lock

1/4
2813
Size: 145 mm

1/4
2814
Size: 145 mm

1/4
2815
Size: 145 mm

1/2
2816
LITTLER
Dissecting Scissors
Size: 115 mm

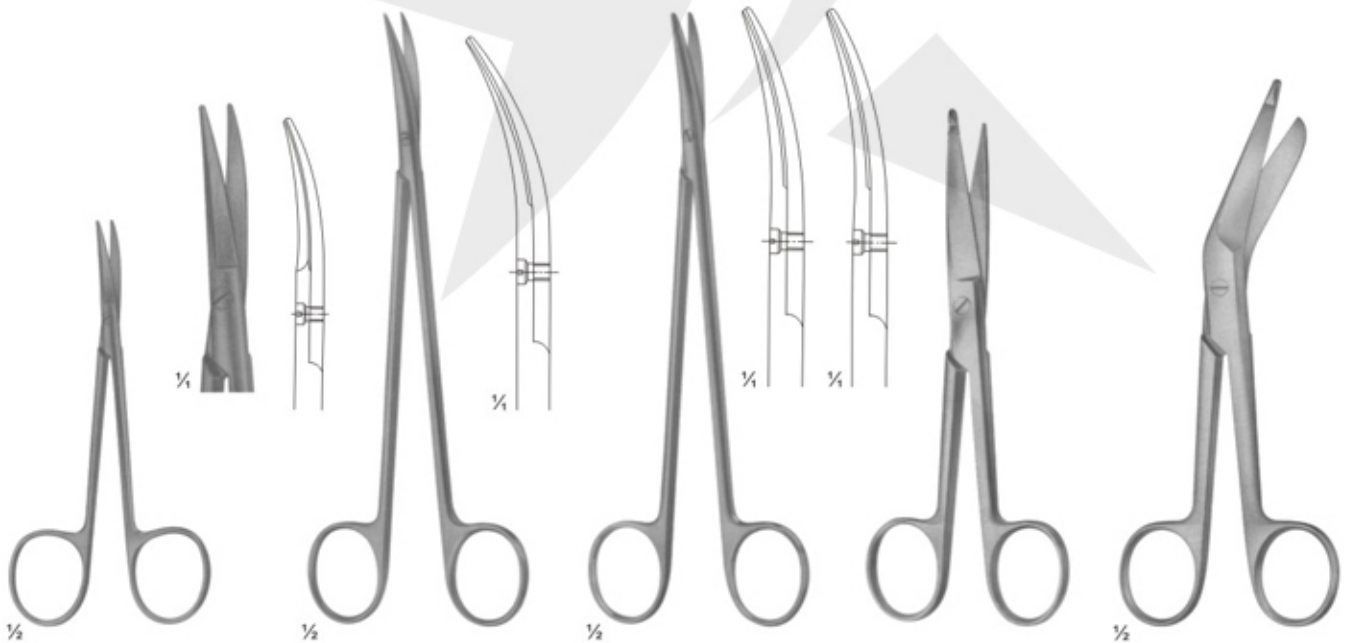

1/2
2817
COTTLE
Bulldog Scissors
Size: 115 mm

1/2
2818
DE BAKEY
Ateriotomy scissors
Size: 175 mm

1/2
2819
TOENNIS - ADSON
Dissecting scissors
Size: 175 mm

1/2
2820
KNOWLES
Size: 145 mm

1/2
2821
LISTER



Scissors

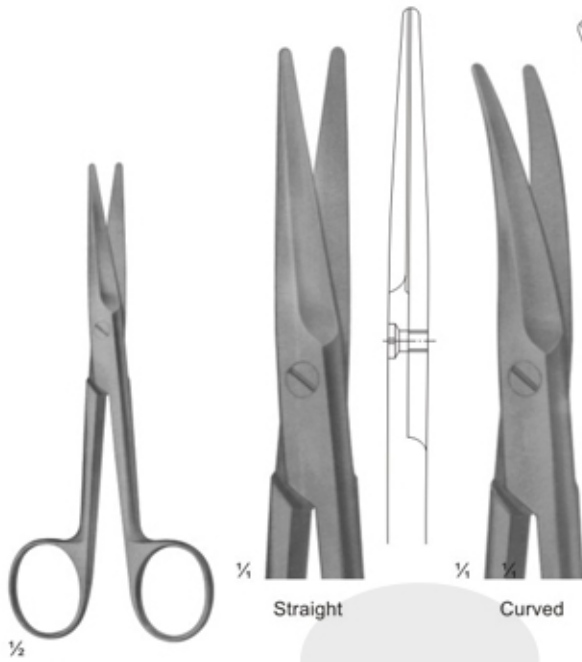

1/2
2822
MAYO(straight)
Size: 140 mm

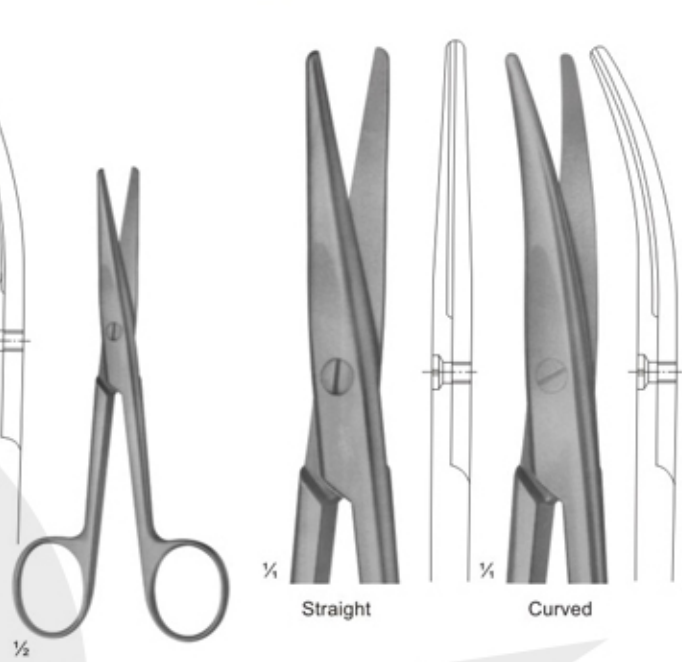

1/2
2823
MAYO-STILLE (straight)
Size: 140 mm

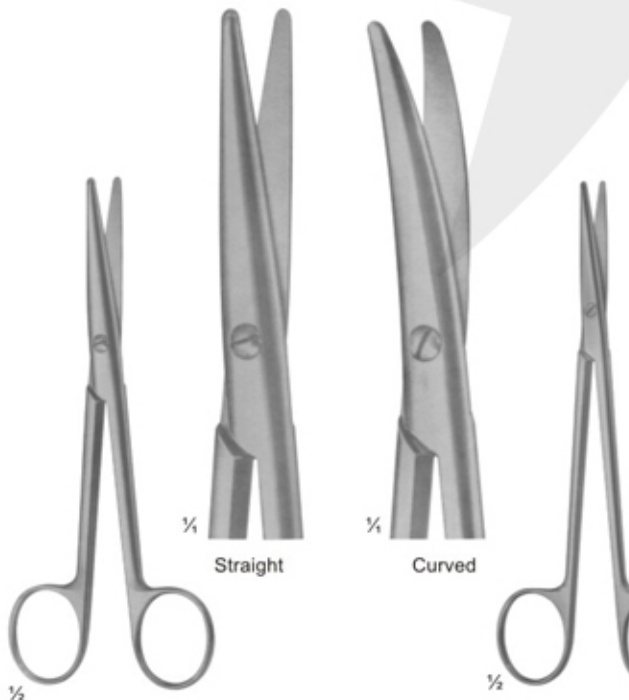

1/2
2824
STILLE
Size: 140 mm

1/2
2825
METZENBAUM
Size: 145 mm

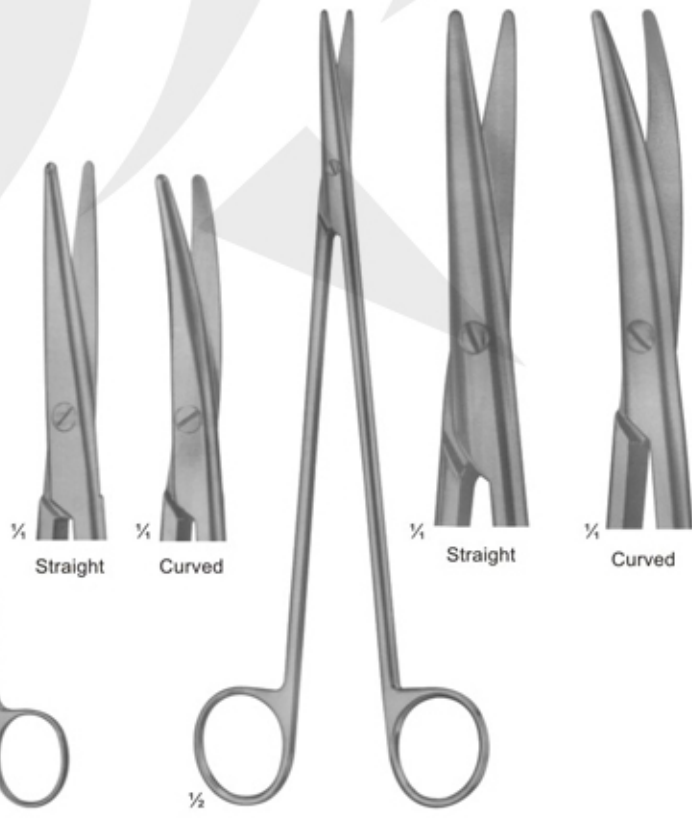

1/2
2826
NELSON-METZENBAUM
Size: 230 mm



Scissors

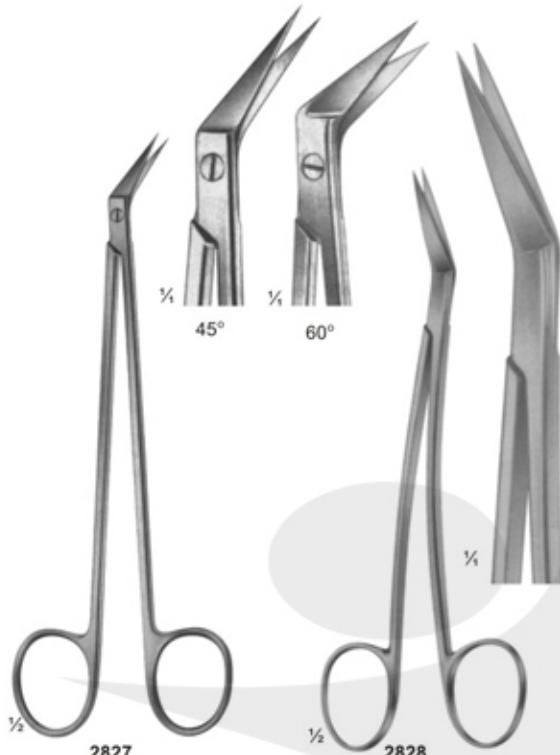

2827
DE BAKEY
Size: 155 mm

2828
LOCKLIN
Curved Sideways,
1 Toothed Blade
Size: 155 mm



2829
LaGrange
Double-Curved
11.5 cm

2830
Goldman-Fox
Double-Curved
13cm



2831
SPENCER
Size: 90 mm

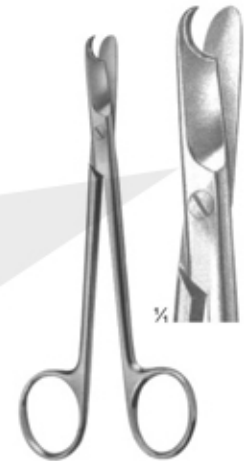

2832
LITTAUER
Size: 135 mm



2833
BEEBE
Size: 110 mm



2838
Dean
17cm

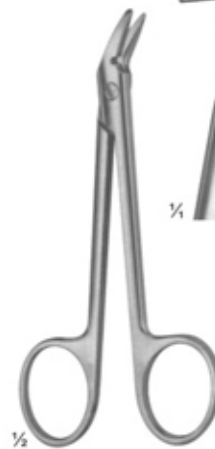

2839
1 Blade Serrated
Size: 120 mm

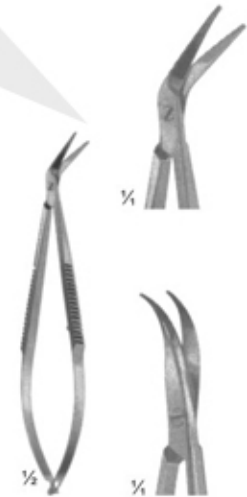

2840
CASTROVIEJO
Size: 90 mm



Impression Trays

Made of 18/8 Stainless Steel, Solid, Set of 10

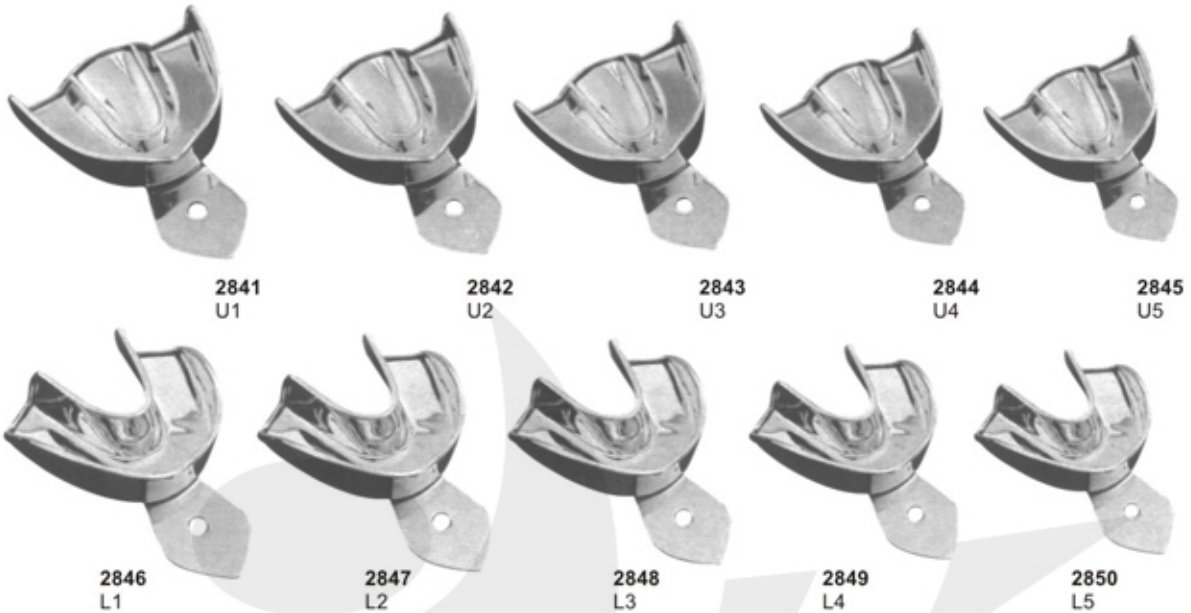

All The Above Impression Trays are Available in These 5 Sizes

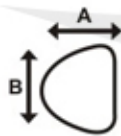

UPPER		U1	U2	U3	U4	U5
	A	62	60	53	54	52
B	83	75	73	69	68	

All Dimension are in mm

LOWER		L1	L2	L3	L4	L5
	A	63	61	57	60	53
B	82	81	78	74	71	

All Dimension are in mm

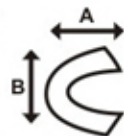

Perforated, Set of 10

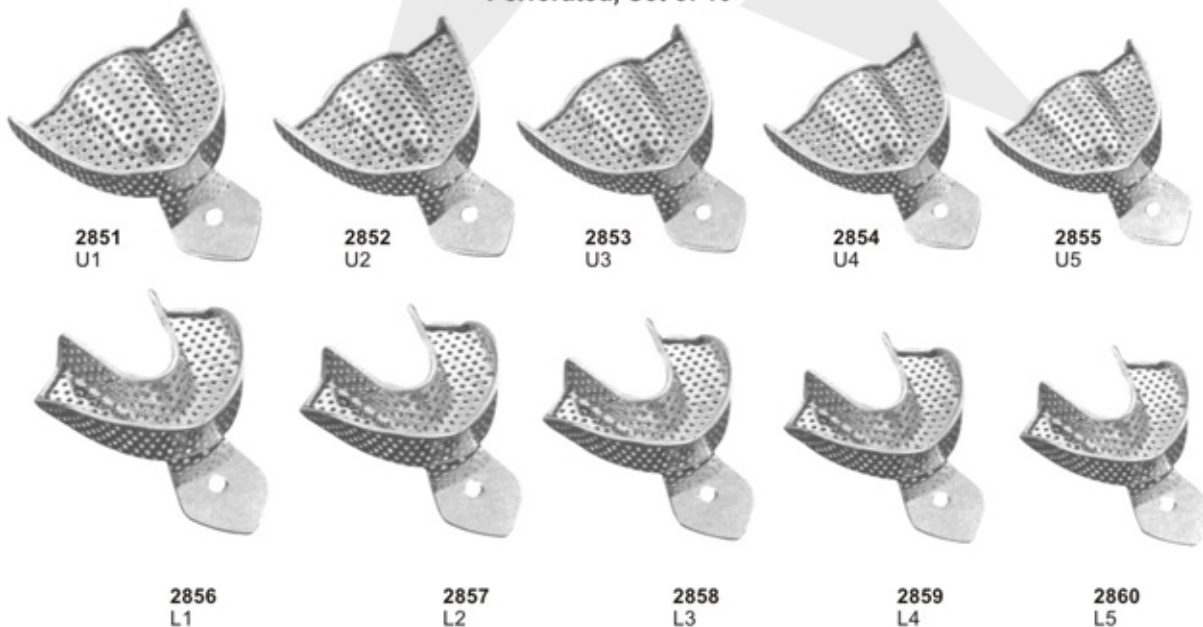



Impression Trays

Made of 18/8 Stainless Steel, Solid Full Denture Set of 8

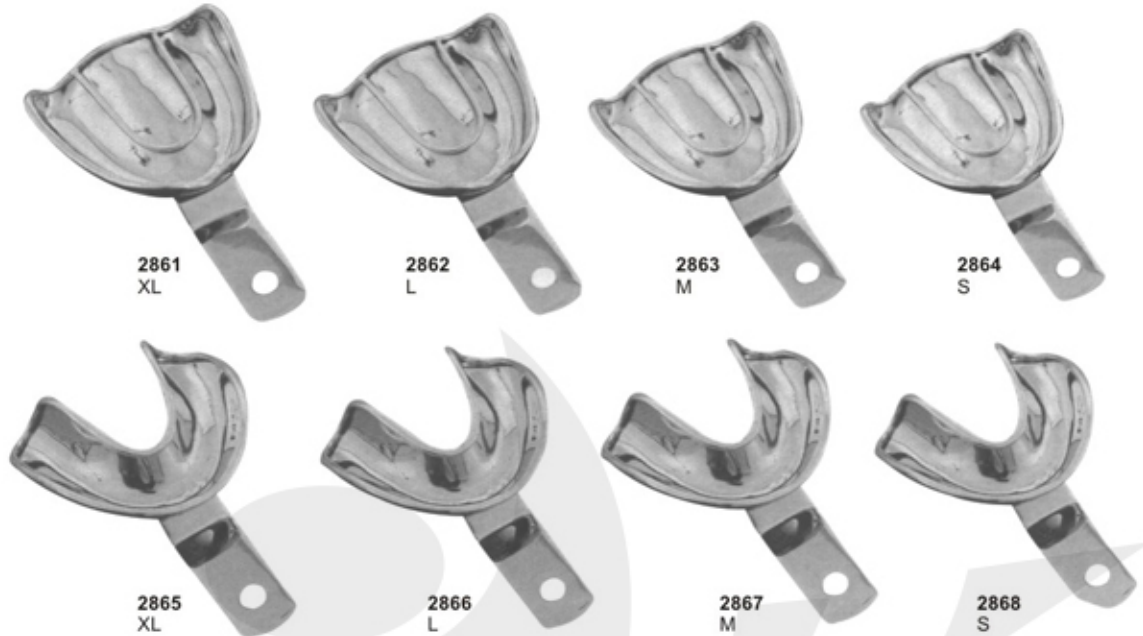

All The Above Impression Trays are Available in These 4 Sizes

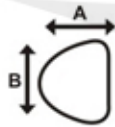

UPPER	XL	L	M	S
A	70	67	64	60
B	79	76	70	73

All Dimension are in mm

LOWER	XL	L	M	S
A	64	64	60	57
B	86	70	73	70

All Dimension are in mm

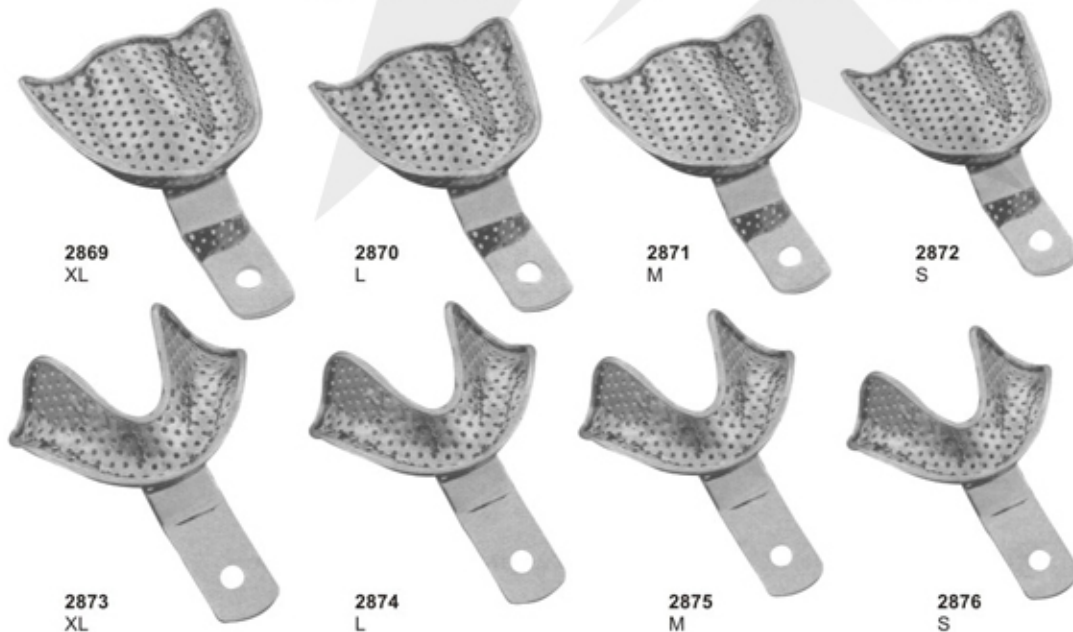

Perforated Full Denture Set of 8



Impression Trays

Made of 18/8 Stainless Steel, Solid Set of 6

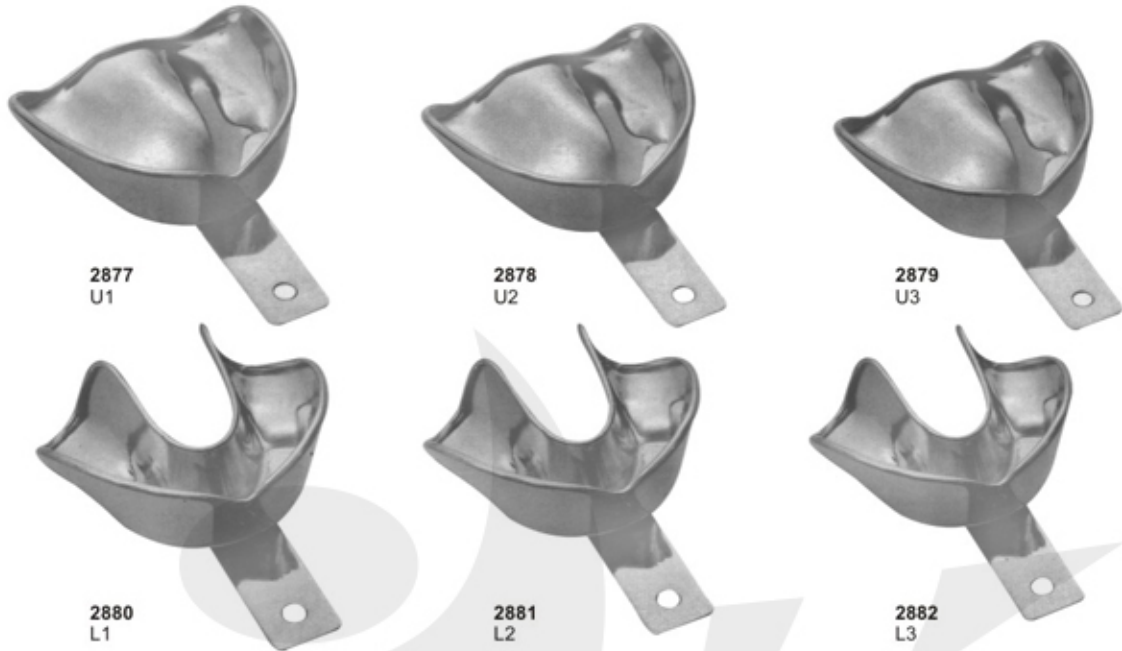

All The Above Impression Trays are Available in These 4 Sizes

UPPER	U1	U2	U3	LOWER	L1	L2	L3
	A	67	64		57	A	60
B	81	71	70	B	81	79	76

All Dimension are in mm

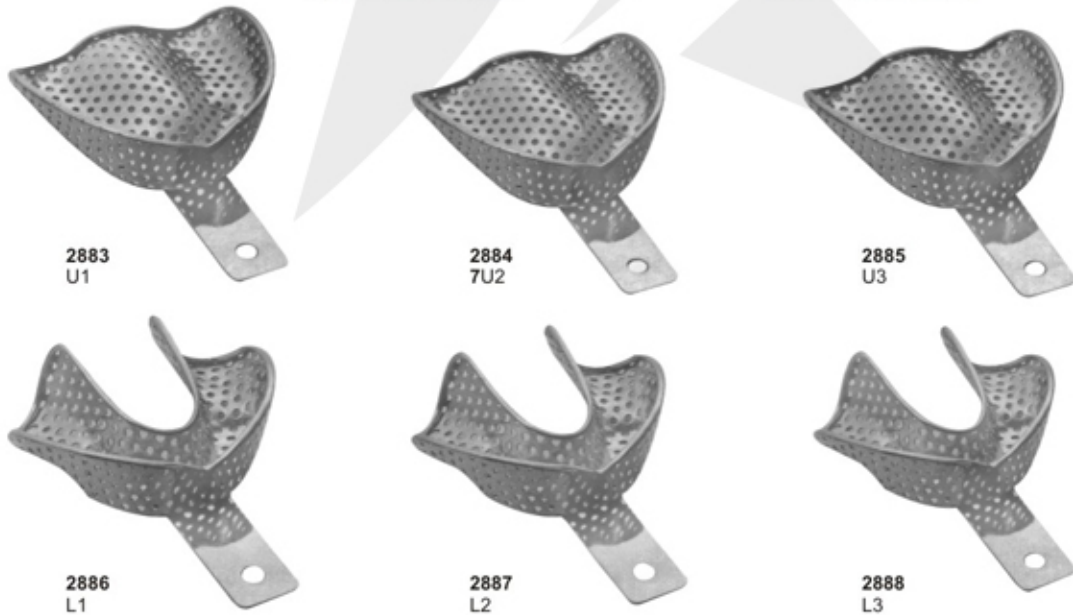

Perforated Set of 6



Impression Trays

Made of 18/8 Stainless Steel, English Pattern Set of 8



2889
Lower



2890
Upper

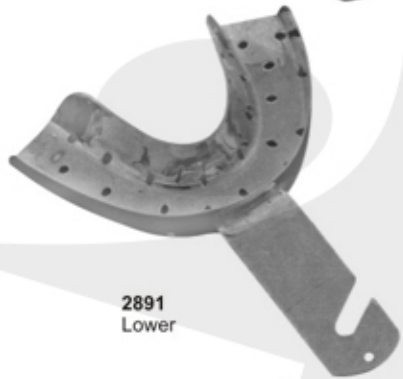

2891
Lower



2892
Upper



2893
Lower



2894
Upper

All The Above Impression Trays are Available in These 4 Sizes

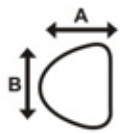

UPPER	Size	A	B	C
	0	67	50	12
	1	72	51	13
	2	78	55	15
	3	80	58	15

All Dimension are in mm



LOWER	Size	A	B	C
	0	70	50	14
	1	77	51	15
	2	79	55	15
	3	80	60	17

All Dimension are in mm



Impression Trays

Made of 18/8 Stainless Steel, Solid Full Denture Set of 8

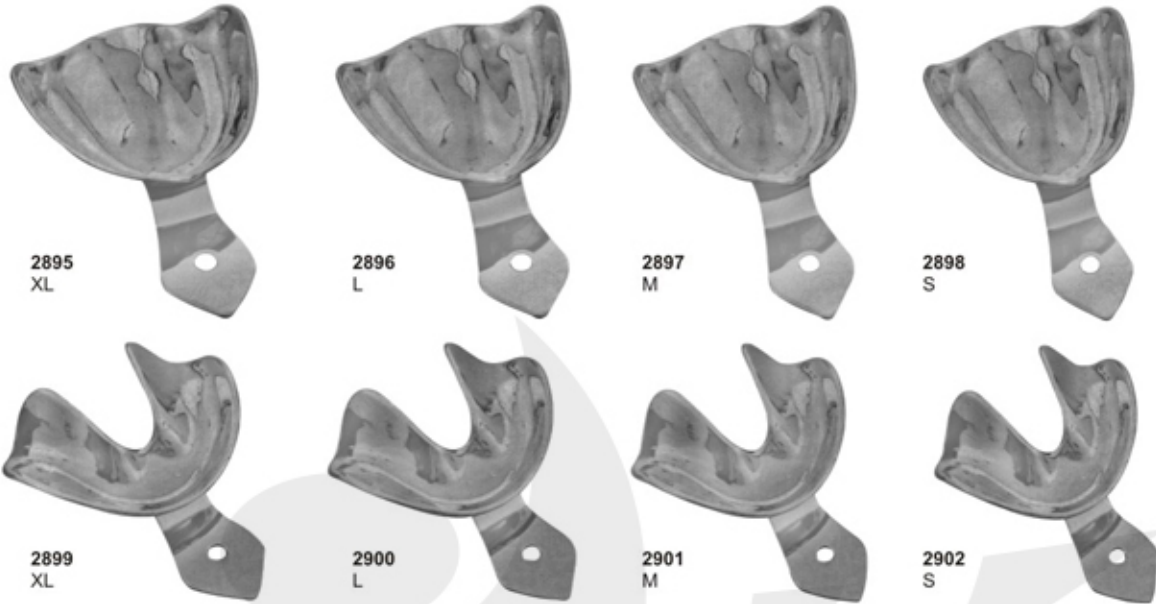

All The Above Impression Trays are Available in These 4 Sizes

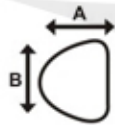

UPPER	XL	L	M	S
	A	70	67	64
B	79	76	70	73

All Dimension are in mm

LOWER	XL	L	M	S
	A	64	64	60
B	86	70	73	70

All Dimension are in mm

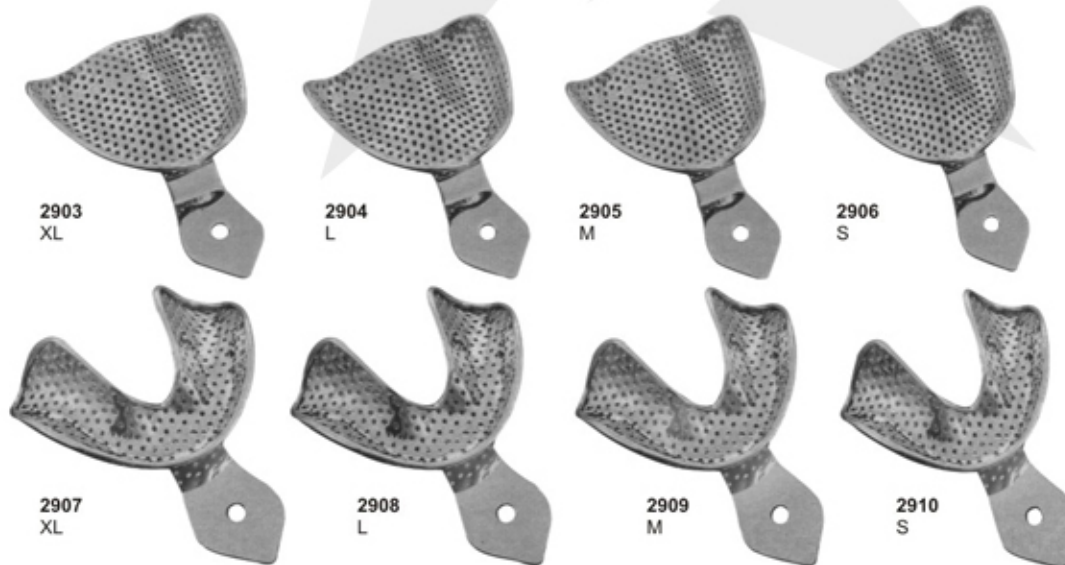

Made of 18/8 Stainless Steel, Perforated Full Denture Set of 8



Impression Trays

Made of 18/8 Stainless Steel, Solid Full Denture Set of 8

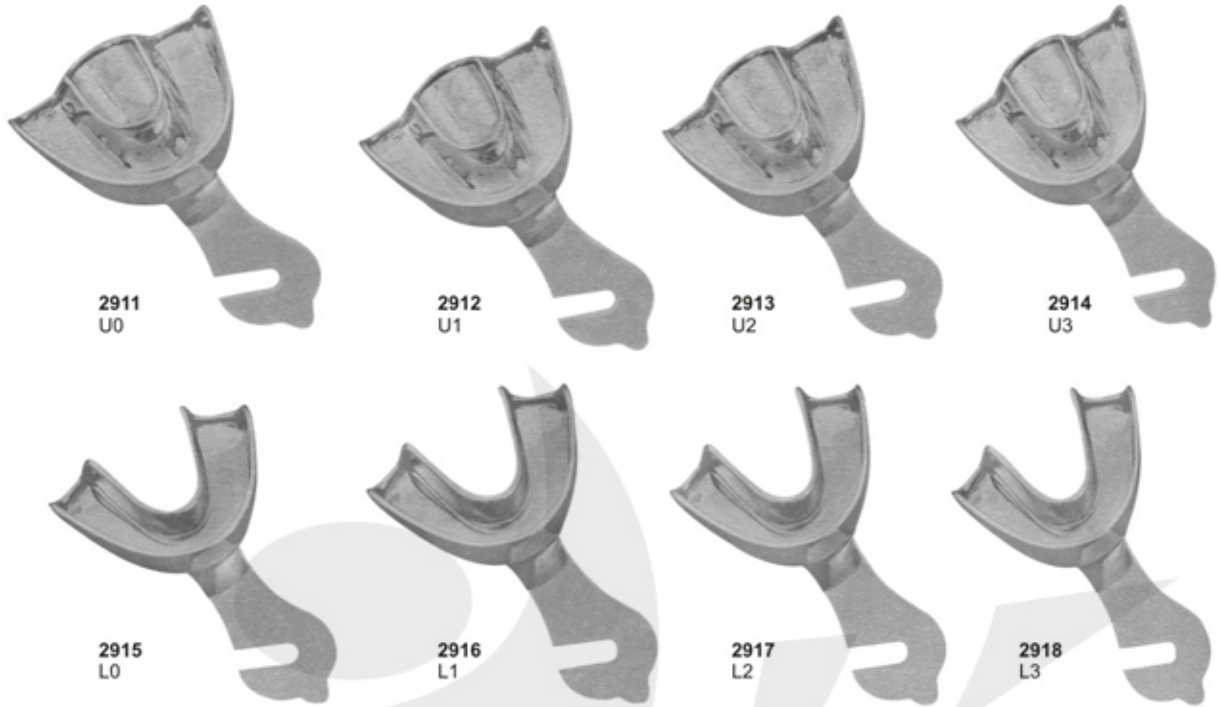

2911
U0

2912
U1

2913
U2

2914
U3

2915
L0

2916
L1

2917
L2

2918
L3

Upper Sizes: 0,1,2,3

Depth of Tray: 15,9 mm, Height of Plate: 12,5 mm

Lower Sizes: 0,1,2,3

Depth of Tray: 12,9 mm

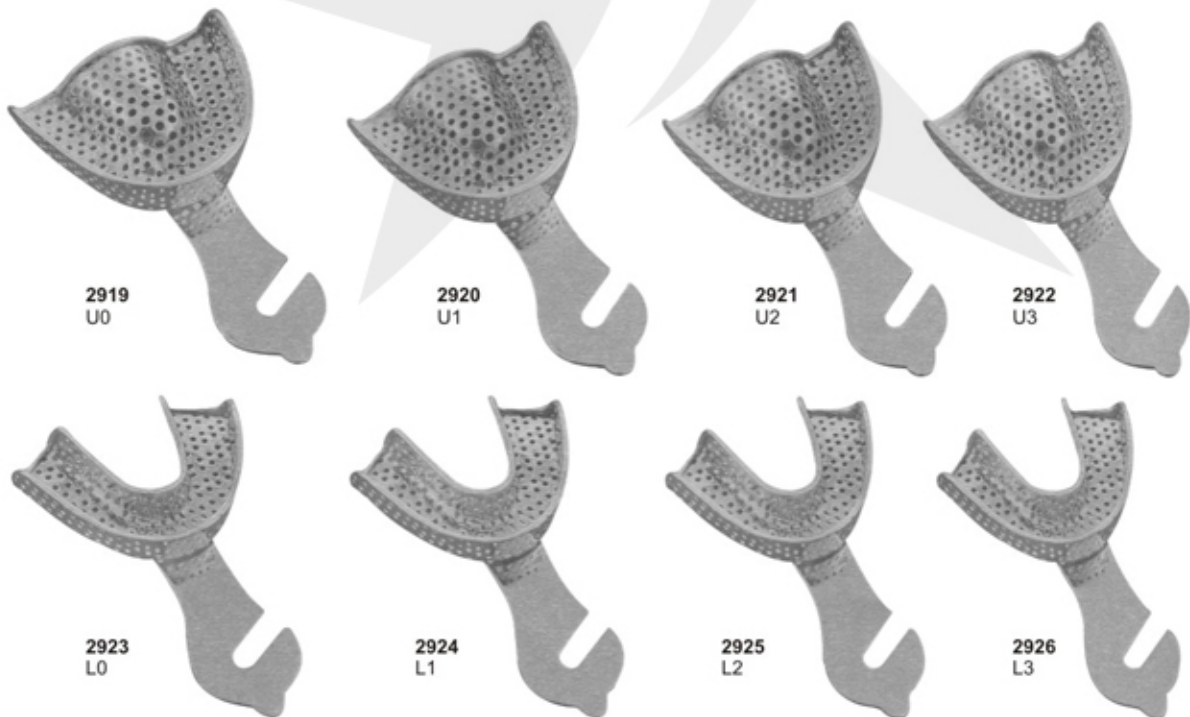

2919
U0

2920
U1

2921
U2

2922
U3

2923
L0

2924
L1

2925
L2

2926
L3

Made of 18/8 Stainless Steel, Perforated Full Denture Set of 8



Impression Trays

Impression Trays For Crown & Bridge Work

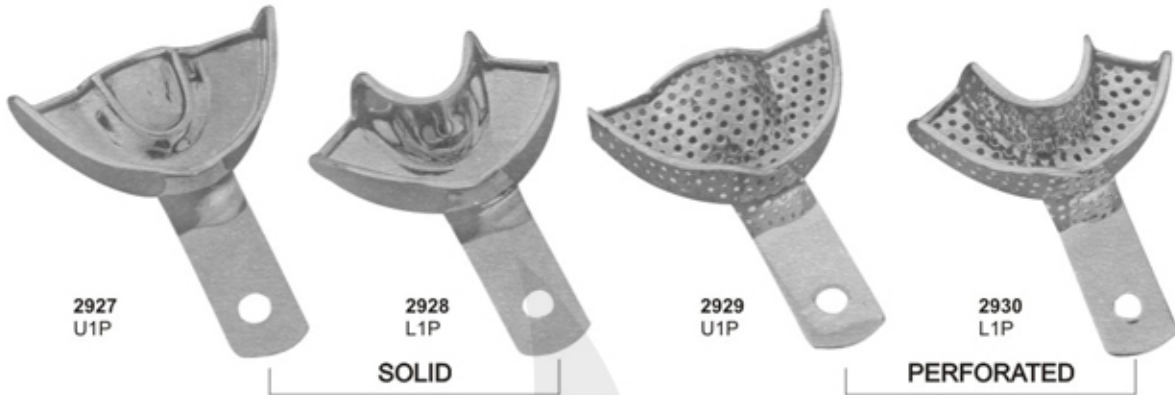

2927
U1P

2928
L1P

2929
U1P

2930
L1P

SOLID

PERFORATED

2932
Adjustable
Perforated

2933
Adjustable
Solid

PERFORATED

SOLID



2931-A
For upper right jaw
For lower left jaw

2931-B
For upper left jaw
For lower right jaw

2931-C
For upper right jaw
For lower left jaw

2931-D
For upper left jaw
For lower right jaw

Available in 4 sizes

- 1.....44 mm
- 2.....55 mm
- 3.....60 mm
- 4.....65 mm

Available in 4 sizes

- 1.....44 mm
- 2.....55 mm
- 3.....60 mm
- 4.....65 mm



Articulators

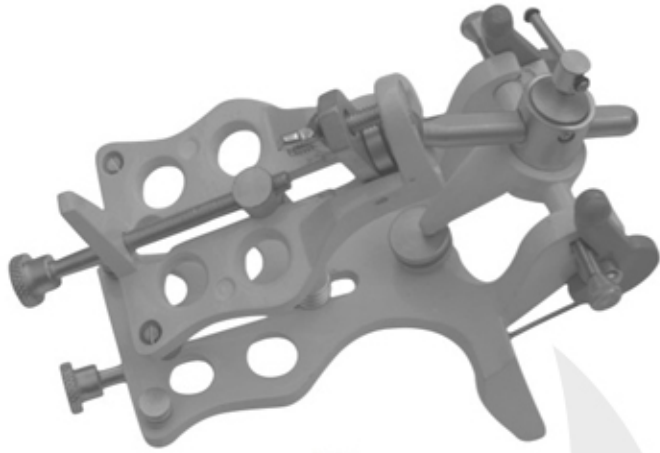

2940



2941



2942



2943



2944



2945



2946



2947



Hollow Wares



2948
Instruments Tray of 20 Pcs

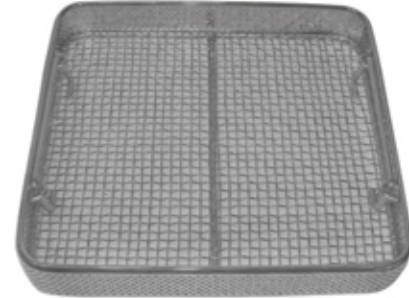

2951
Instruments Riddle



2949
Instruments Tray of 7 Pcs



2949-A
Instruments Tray of 10 Pcs

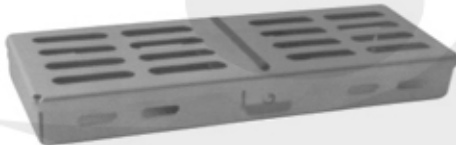

2950
Instruments Tray of 5 Pcs

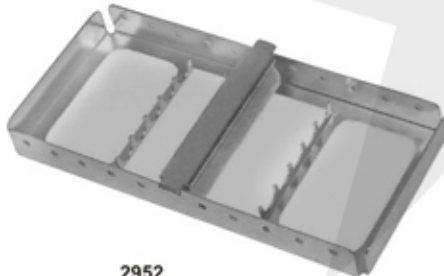

2952
Instruments Tray of 5 Pcs

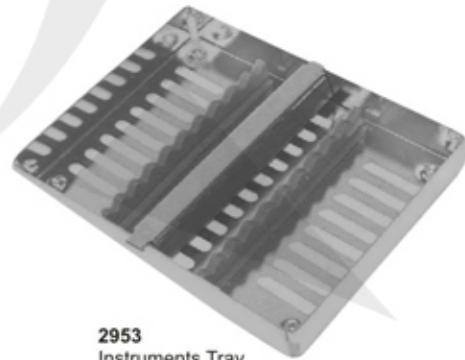

2953
Instruments Tray



2954
Instruments Tray
Perforated



2955
Instruments Tray
Perforated Base



2956
Instruments Tray
Solid Base



Hollowares

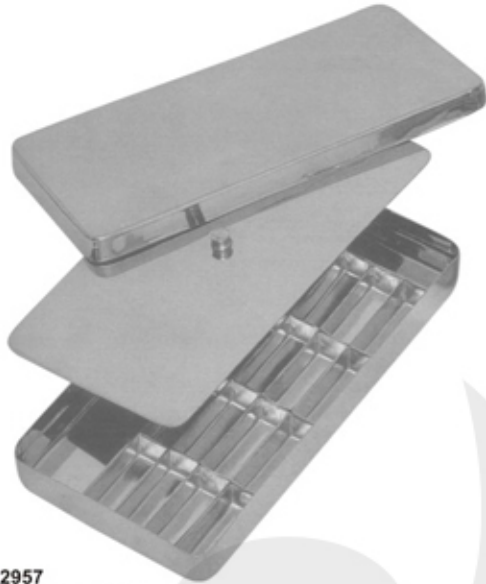

2957
Pulpectomy Tray



2958
Sterilizing Box
Available Sizes:
17x17x3 cm
20x10x6 cm
30x14x6 cm



2959
Endo Tray Box



2960
Finger Cup



2961
Bur Box

2962
Sterilizing Drum
150x150mm
175x175mm
190x190mm
200x140mm
200x200mm
240x120mm
225x225mm
240x240mm
290x160mm



2963
Sterilizing Drum
280x240mm
230x150mm
300x250mm
340x160mm
350x250mm
390x200mm
380x300mm
100x100mm
150x120mm



Hollowares



2957
Pulpectomy Tray



2958
Sterilizing Box
Available Sizes:
17x17x3 cm
20x10x6 cm
30x14x6 cm



2959
Endo Tray Box



2960
Finger Cup



2961
Bur Box

2962
Sterilizing Drum
150x150mm
175x175mm
190x190mm
200x140mm
200x200mm
240x120mm
225x225mm
240x240mm
290x160mm



2963
Sterilizing Drum
280x240mm
230x150mm
300x250mm
340x160mm
350x250mm
390x200mm
380x300mm
100x100mm
150x120mm



Sterilizing Boxes & Instruments Trays



2964
Instruments Box



2965
Instruments Box



2966
Instruments Box



2967
Instruments Sterilizer
150x75 mm



2968
Endodontic Box



2969
Sterilizing Box
320x120 mm



2970
Instruments Tray



2971
Instruments Tray



2972
Instruments Tray
(Perforated)



2973
Instruments Tray
Shallow(Mayo)

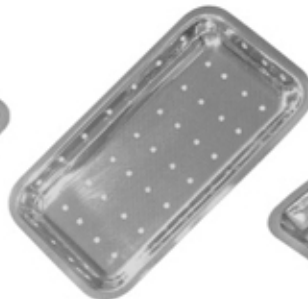

2974
Scaler Tray
20.0 x 10.0 x 1.5 cm



2975
Scalers Tray



2976
Scalers Tray



Hollow Wares

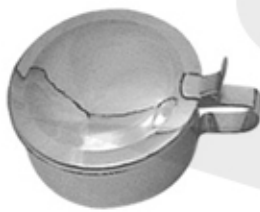

2982
Spitten Mug



2983
Spirit Burner With Wick
Stainless Steel 18/10
Capacity: 150 ml, 60 ml



2984
Spirit Burners With Wick
Stainless Steel 18/10
Capacity: 70ml



2985
Dressing Jar



2986
Dressing Jar



2987
Irrigator (Douch Can)



2988
Measuring Jug



Hollow Wares



2989
Sponge Bowl

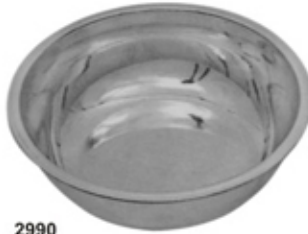

2990
Wash Basin
300mm-350mm-400mm



2994
Kick Bucket With Trolley



2991
Sponge Bowl



2992
Gallipot



2993
Medicine Cup

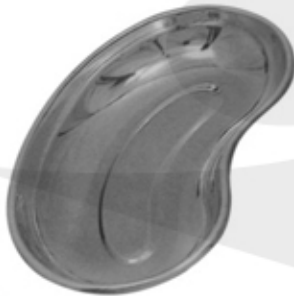

2995
Kidney Tray Shallow
150mm-200mm-240mm-300mm



2996
Kidney Tray Without Lid
150mm-200mm-250mm-300mm



2997
Kidney Tray With Lid
150mm-200mm-250mm-300mm

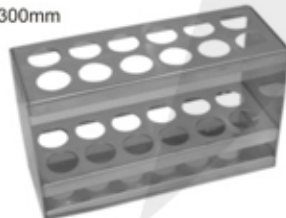

2998
Tube Rack, Stainless Steel 18/10

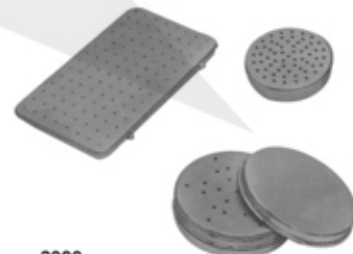

2999
Needle Case Rectangle
Needle Case Round With Cover
90x15



3000
Dustbin Without Stand
6-10-12 Ltr



3001
Tube Rack, Round Model
Stainless Steel 18/10



3002
Dustbin Without Stand & Cap
6-10-12 Ltr

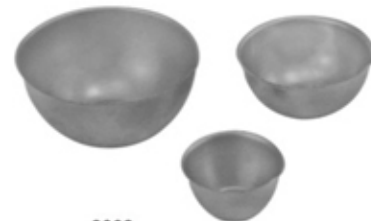

3003
Lotion Bowl With Lip
40-60-80-100-120-150-180-200mm



Scissors With Tungsten Carbide Inserts

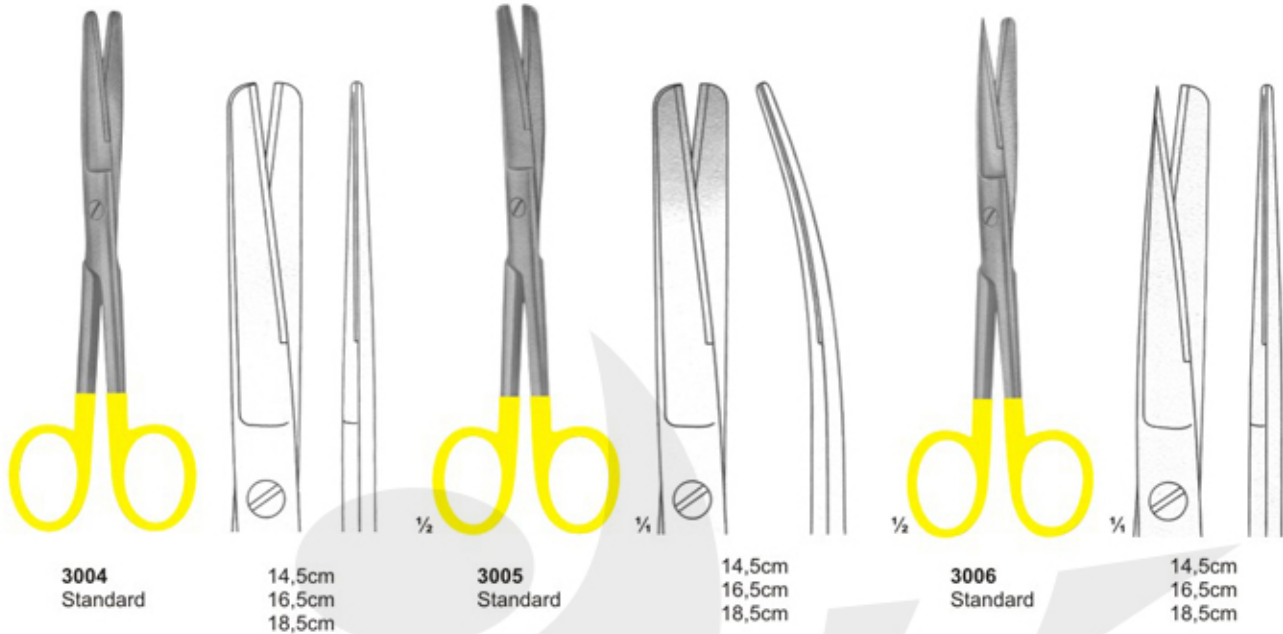

3004
Standard

14,5cm
16,5cm
18,5cm

3005
Standard

14,5cm
16,5cm
18,5cm

3006
Standard

14,5cm
16,5cm
18,5cm

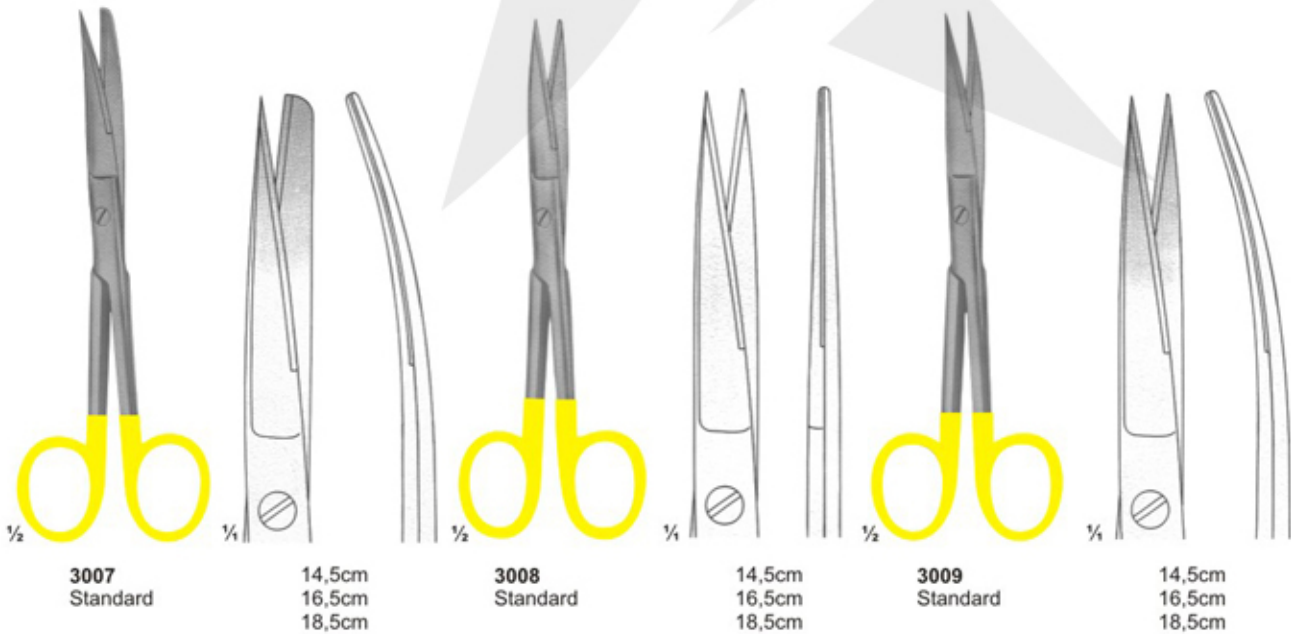

3007
Standard

14,5cm
16,5cm
18,5cm

3008
Standard

14,5cm
16,5cm
18,5cm

3009
Standard

14,5cm
16,5cm
18,5cm



Scissors With Tungsten Carbide Inserts

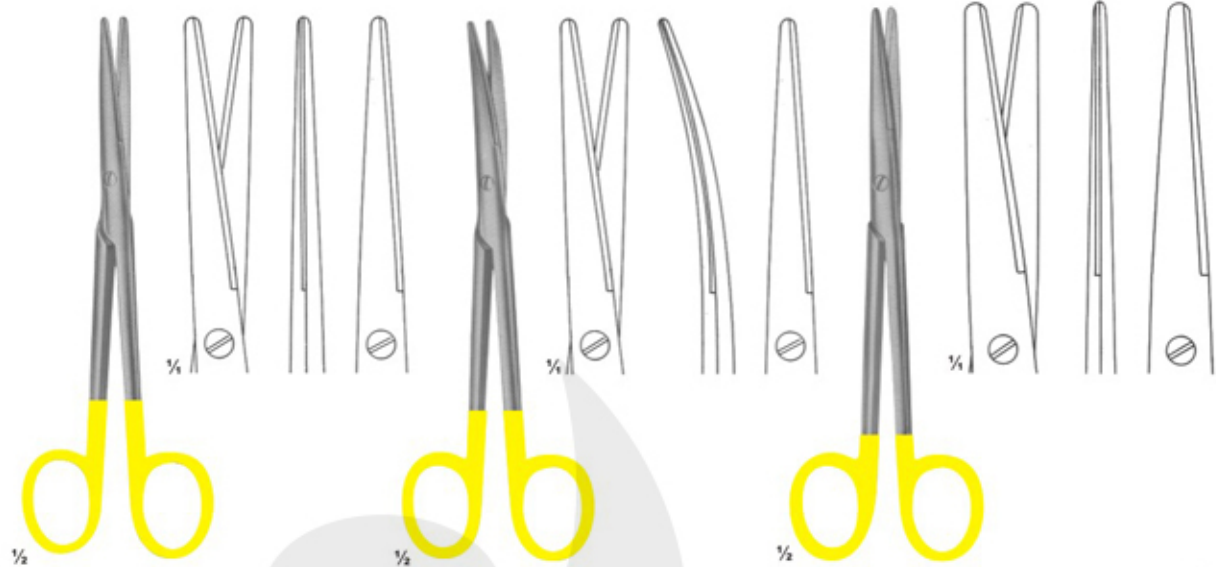

1/2
3010
MAYO-LEXER
Straight
16 cm

1/2
3011
MAYO-LEXER
Curved
16 cm

1/2
3012
LEXER
Straight
16, 21 cm

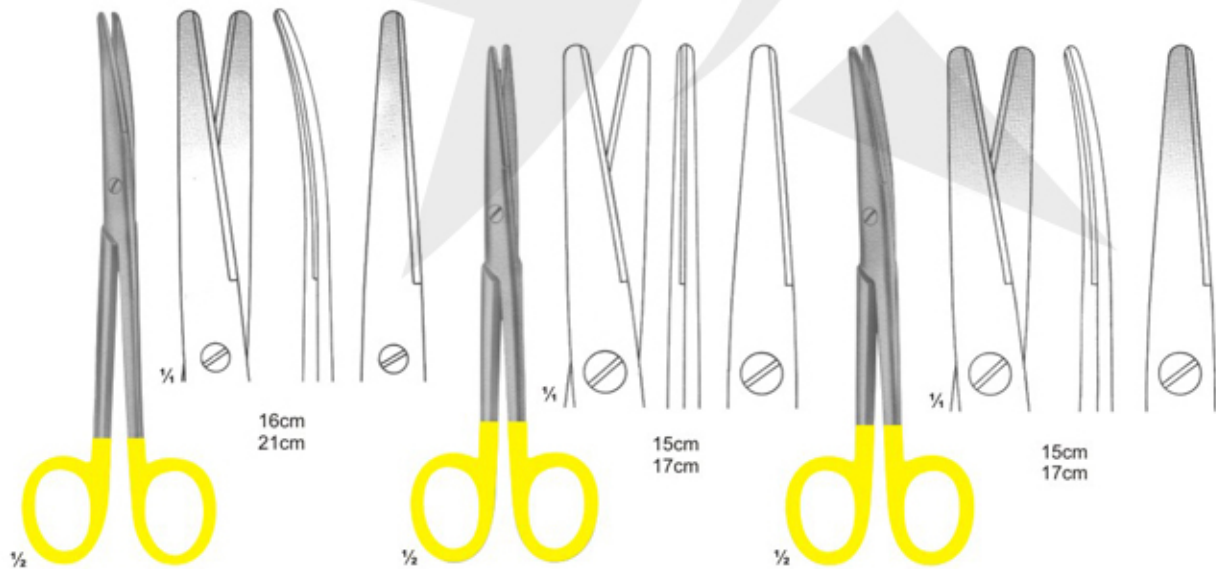

1/2
3013
LEXER
Curved
16, 21 cm

1/2
3014
MAYO-STILLE
Straight
15, 17 cm

1/2
3015
MAYO-STILLE
Curved
15, 17 cm



Scissors With Tungsten Carbide Inserts

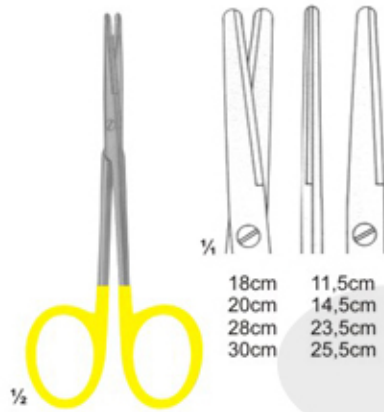

3016
METZENBAUM
Straight

18cm
20cm
28cm
30cm

11,5cm
14,5cm
23,5cm
25,5cm

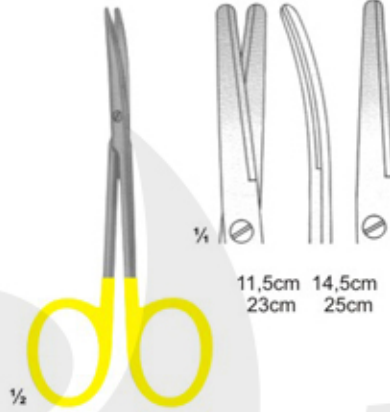

3017
METZENBAUM
Curved

11,5cm
23cm

14,5cm
25cm

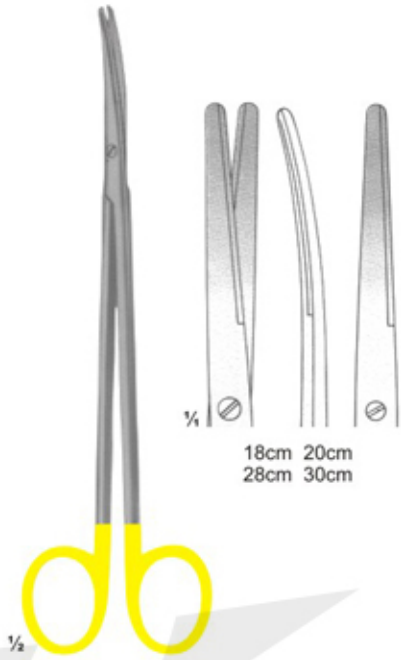

3018
METZENBAUM
Curved

18cm
20cm
28cm
30cm



3019
METZENBAUM FINO
Straight

14cm
23cm

18cm
25cm

20cm
28cm



3020
METZENBAUM FINO
Curved

14cm
23cm

18cm
25cm

20cm
28cm

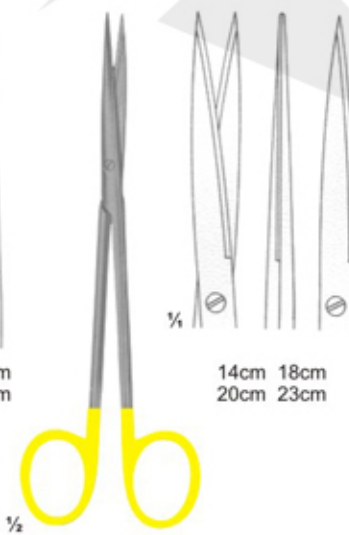

3021
METZENBAUM FINO
Sharp

14cm
20cm

18cm
23cm

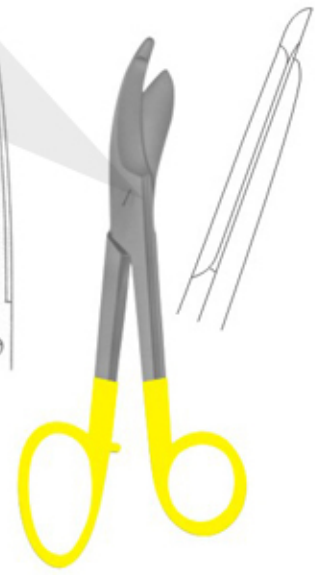

3022
BRUNS
235 mm



Scissors With Tungsten Carbide Inserts

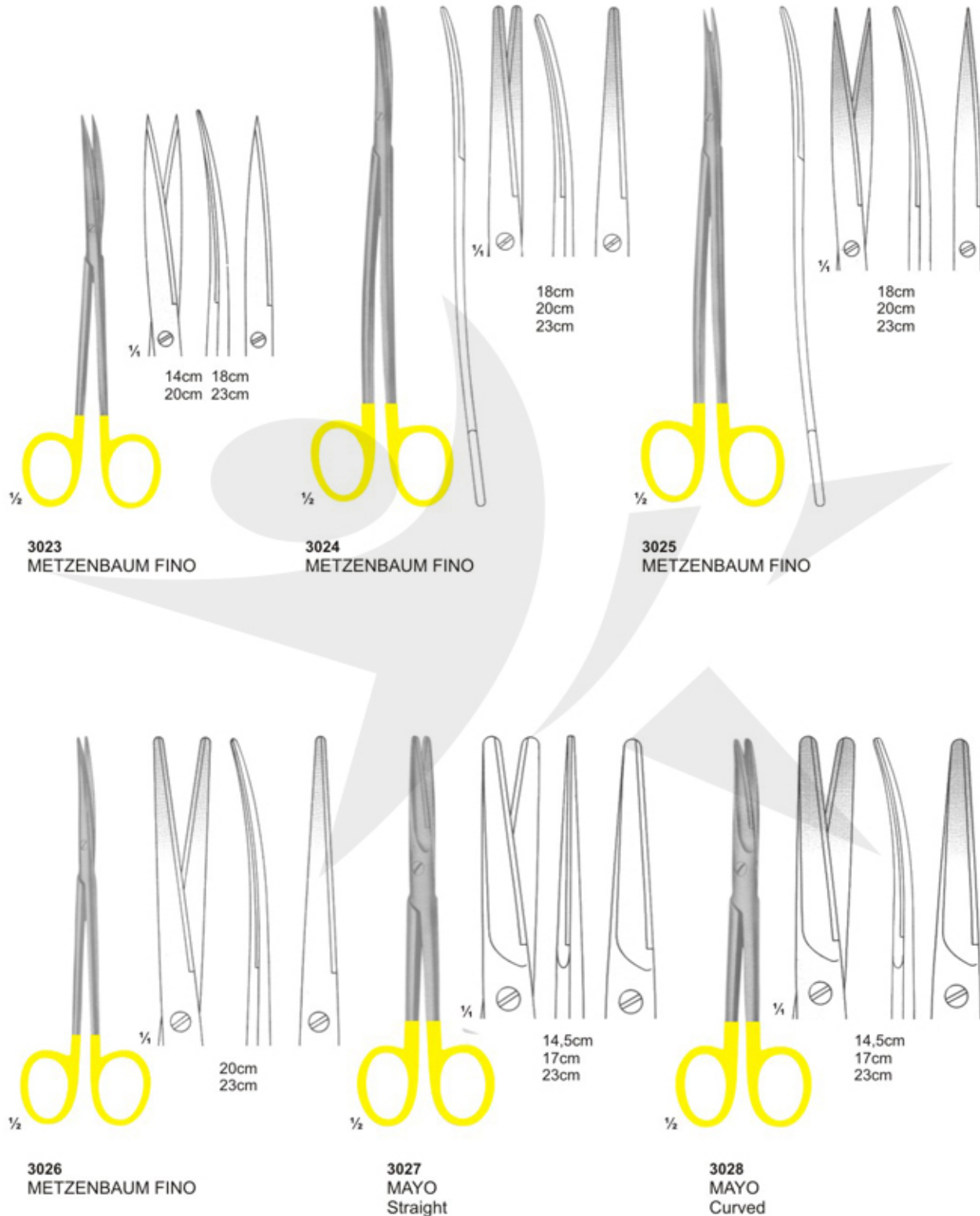



Scissors With Tungsten Carbide Inserts

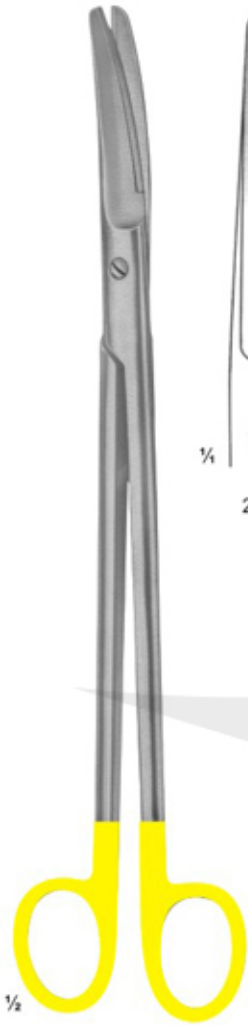

3029
SIMS

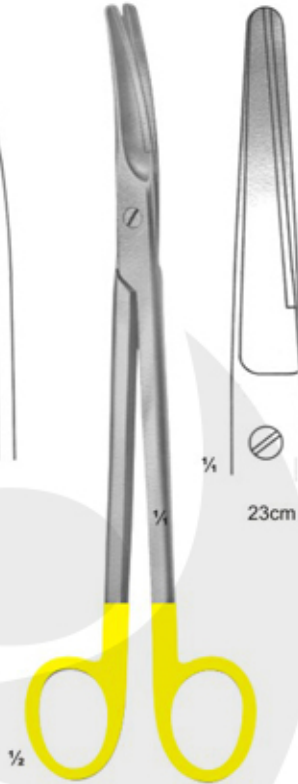
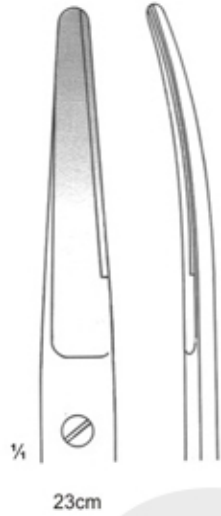

3030
PARAMETRIUM

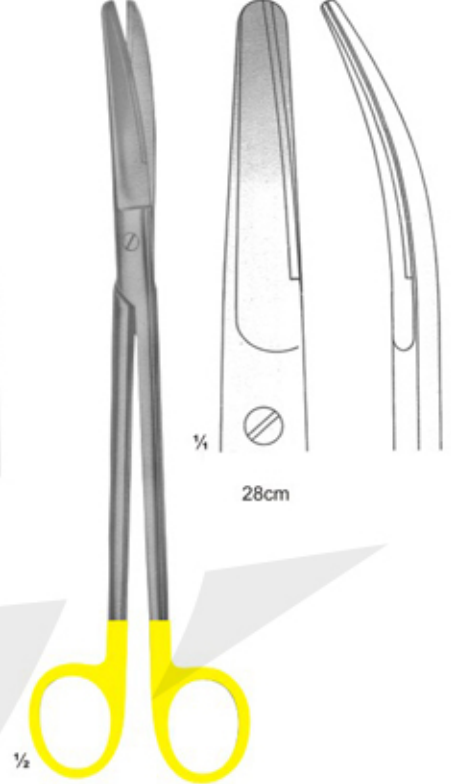

3031
MAYO-HARRINGTON

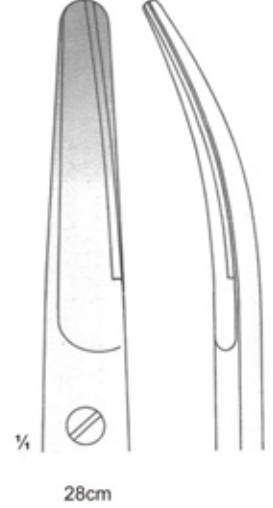

3032
KELLY
Straight 16 cm



3033
KELLY
Curved 16 cm



3034
DEAN
17 cm



3035
LAGRANGE
Double-Curved
11.5 cm



Scissors With Tungsten Carbide Inserts

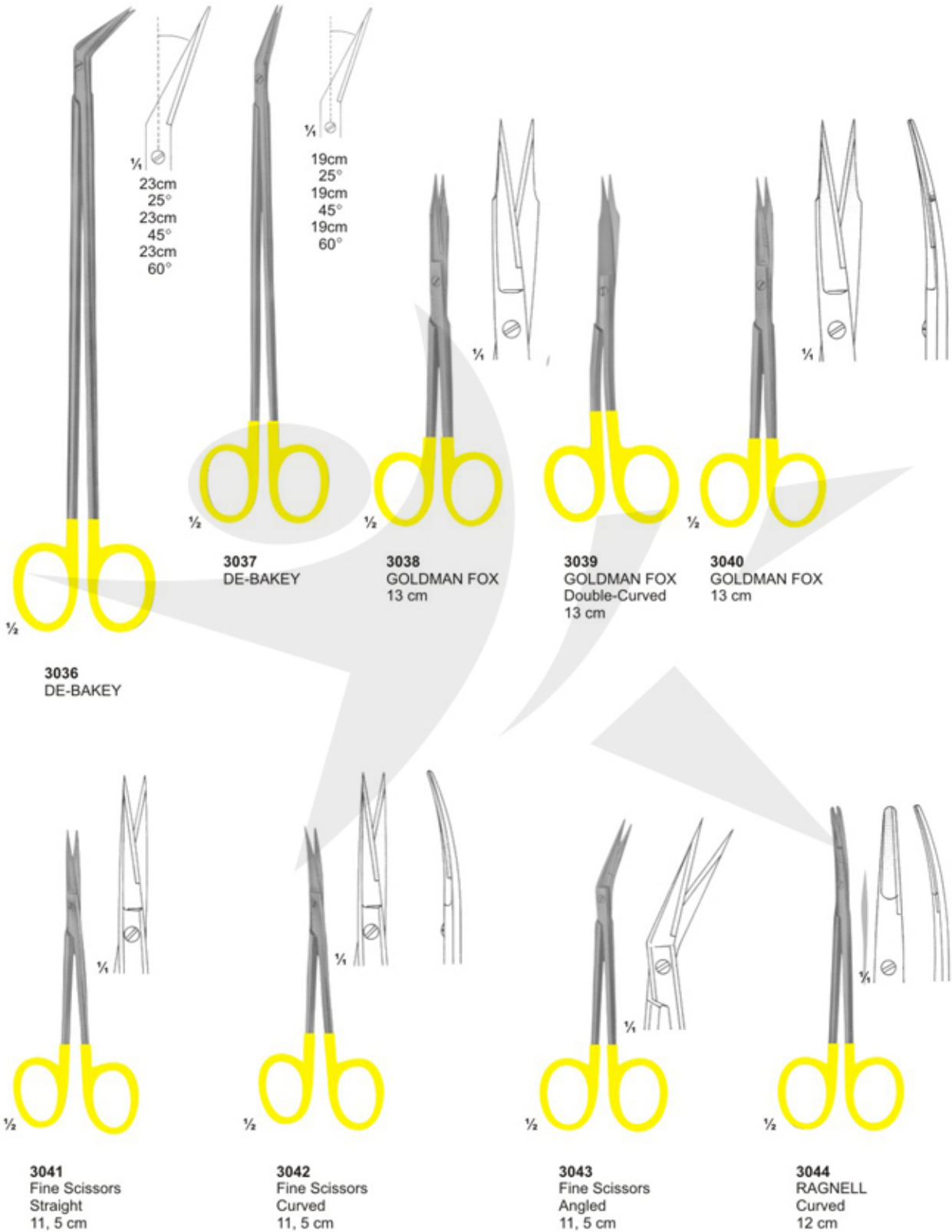

3036
 DE-BAKEY
 23cm
 25°
 23cm
 45°
 23cm
 60°

3037
 DE-BAKEY
 19cm
 25°
 19cm
 45°
 19cm
 60°

3038
 GOLDMAN FOX
 13 cm

3039
 GOLDMAN FOX
 Double-Curved
 13 cm

3040
 GOLDMAN FOX
 13 cm

3041
 Fine Scissors
 Straight
 11, 5 cm

3042
 Fine Scissors
 Curved
 11, 5 cm

3043
 Fine Scissors
 Angled
 11, 5 cm

3044
 RAGNELL
 Curved
 12 cm



Scissors & Dissecting Forceps With Tungsten Carbide Inserts

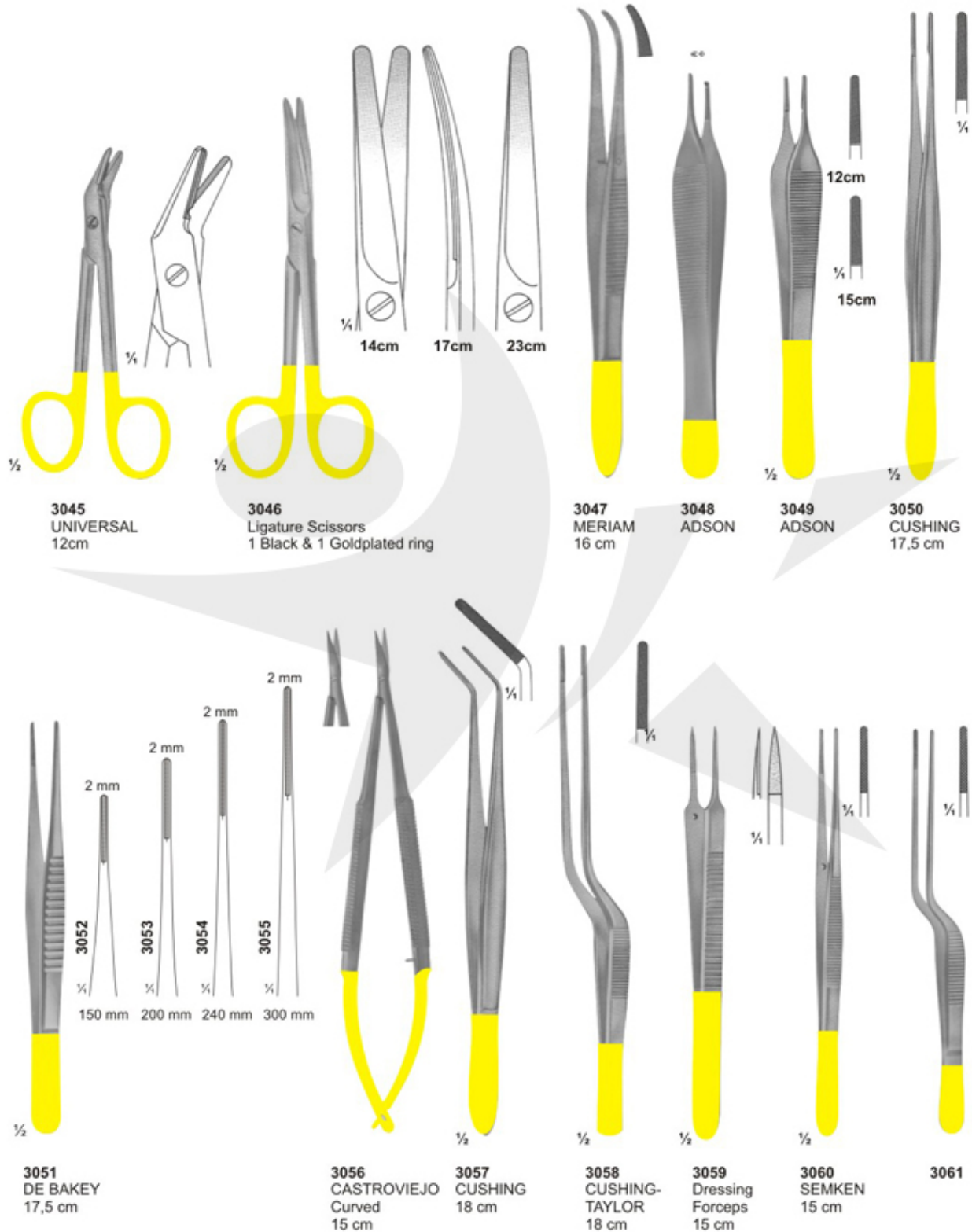



Dissecting Forceps & Needle Holders T.C Instruments

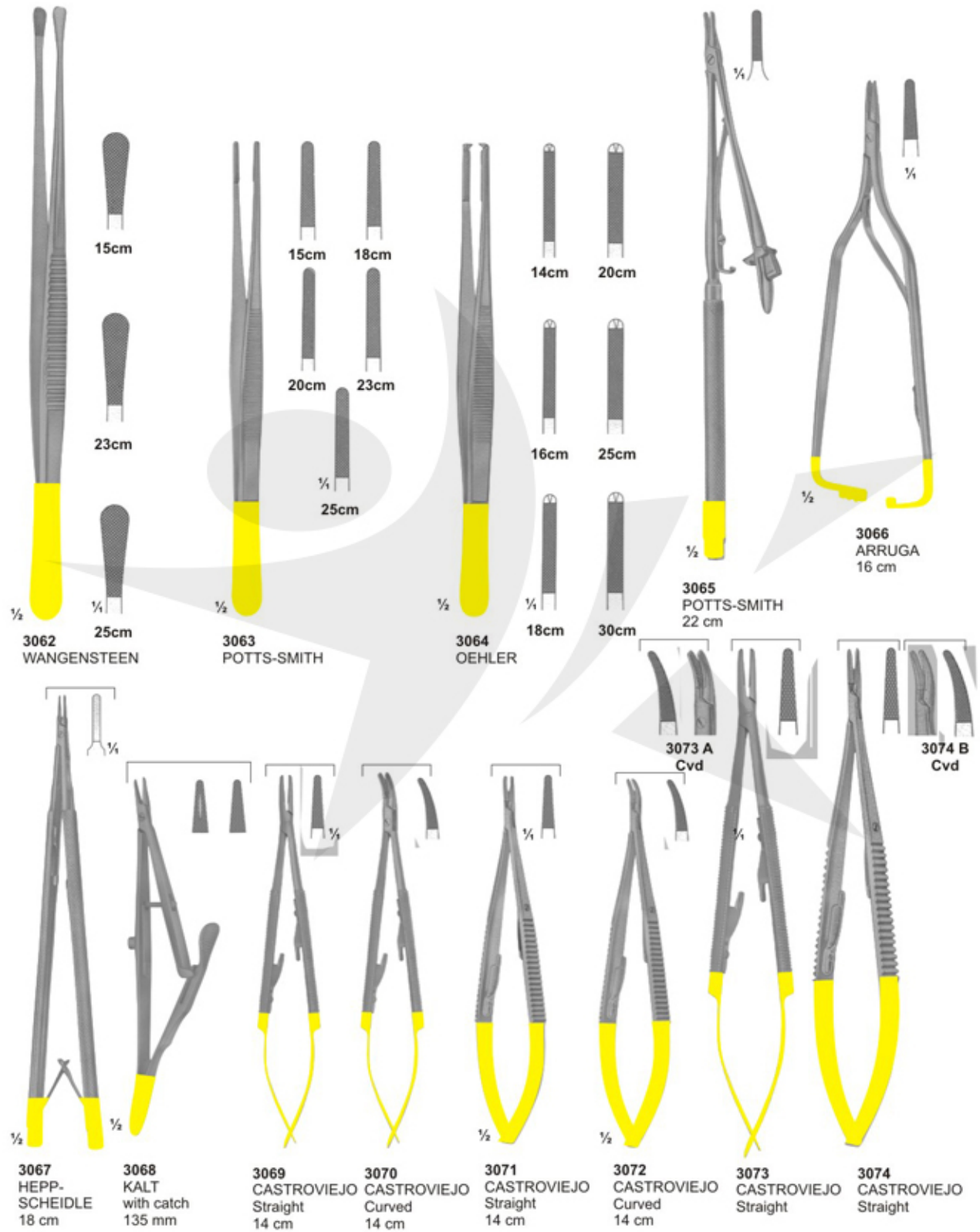



Needle Holders With T.C. Inserts

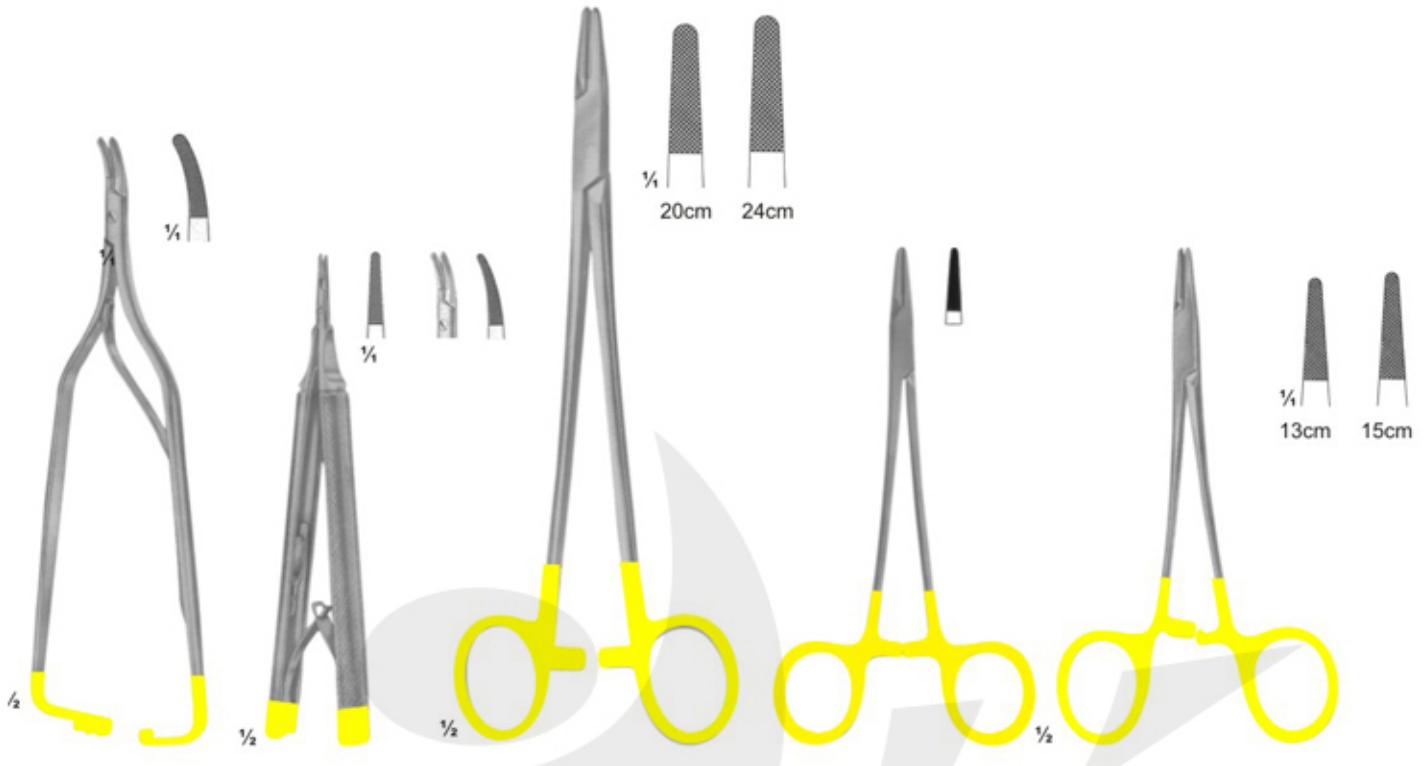

3075
ARRUGA
Curved
16 cm

3076
CASTROVIEJO
13 cm

3077
HEGAR
20,24 cm

3078
SMOOTH TIP
15 cm

3079
HALSEY
13,15 cm

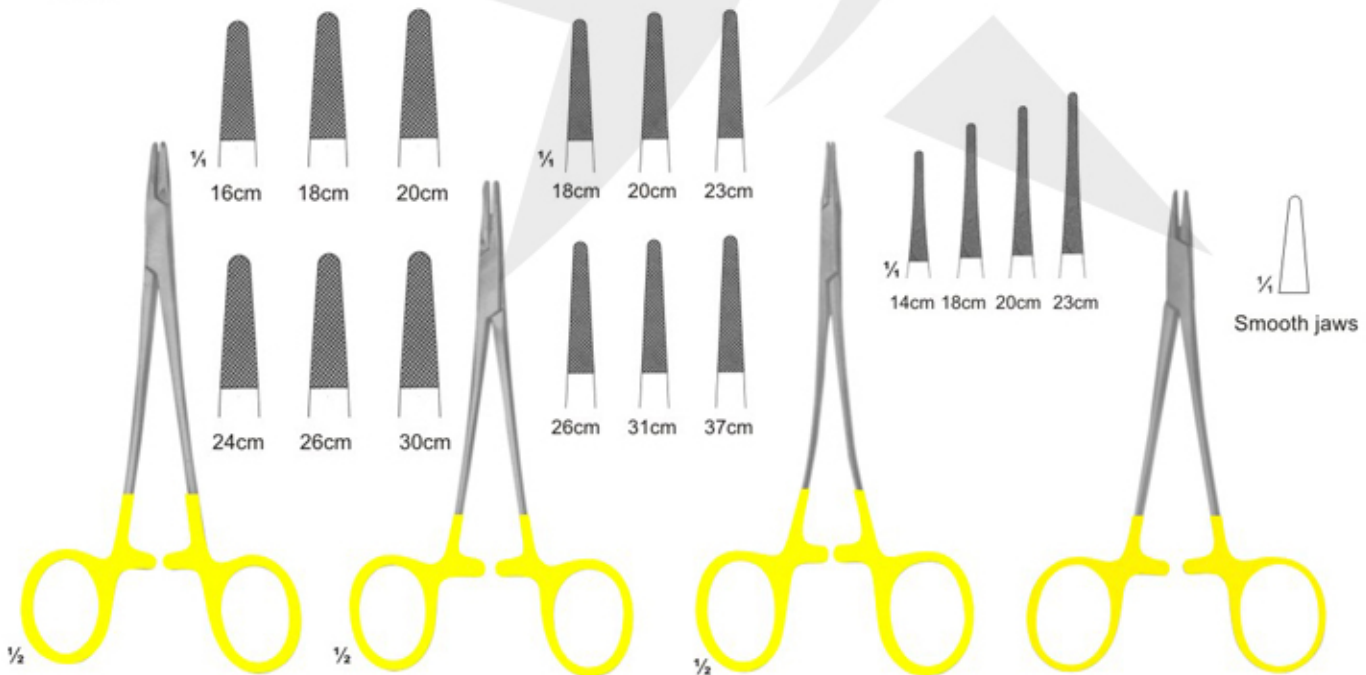

3080
MAYO-HEGAR

3081
DE BAKEY

3082
HEGAR-VASCULAR

3083
WEBSTER
125 mm



Needle Holders With Tungsten Carbide Inserts

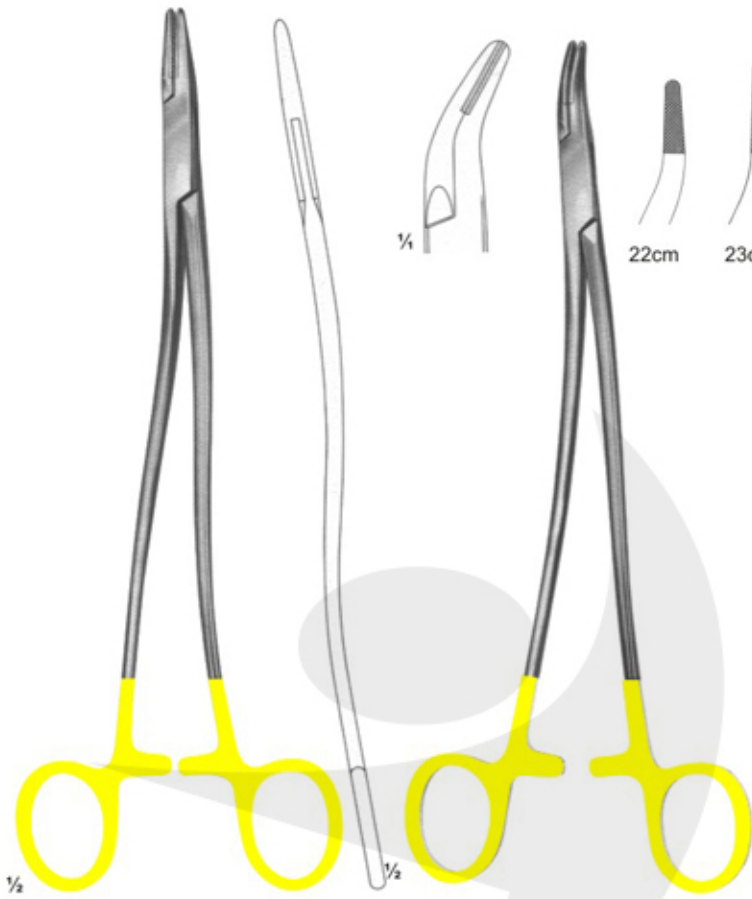

3084
BOZEMANN-WERTHEIM
20, 24, 26 cm

3085
STRATTE

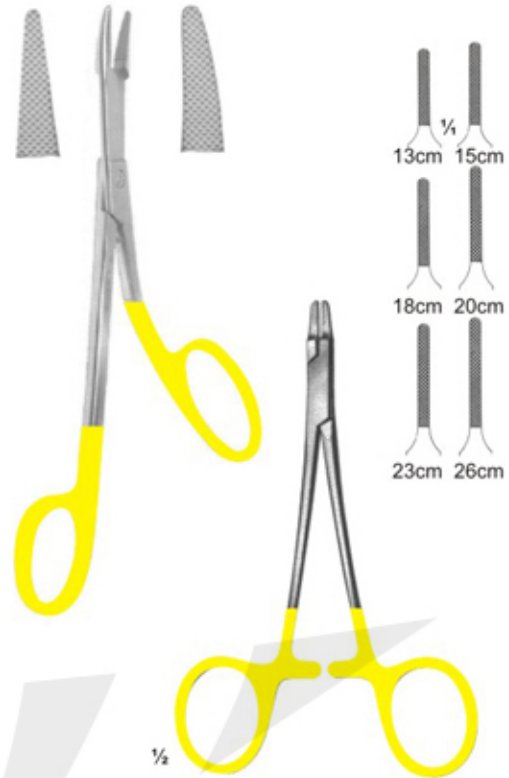

3086
RYDER



3087
RYDER-VASCULAR

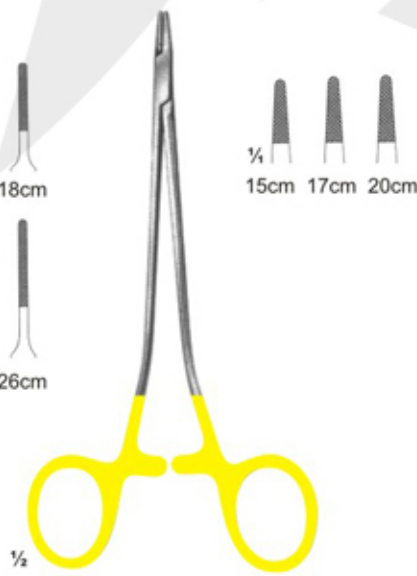

3088
MARTIN

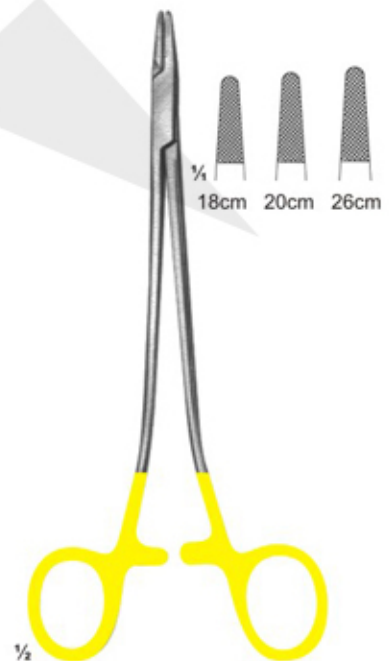

3089
SAROT



Needle Holders With Tungsten Carbide Inserts

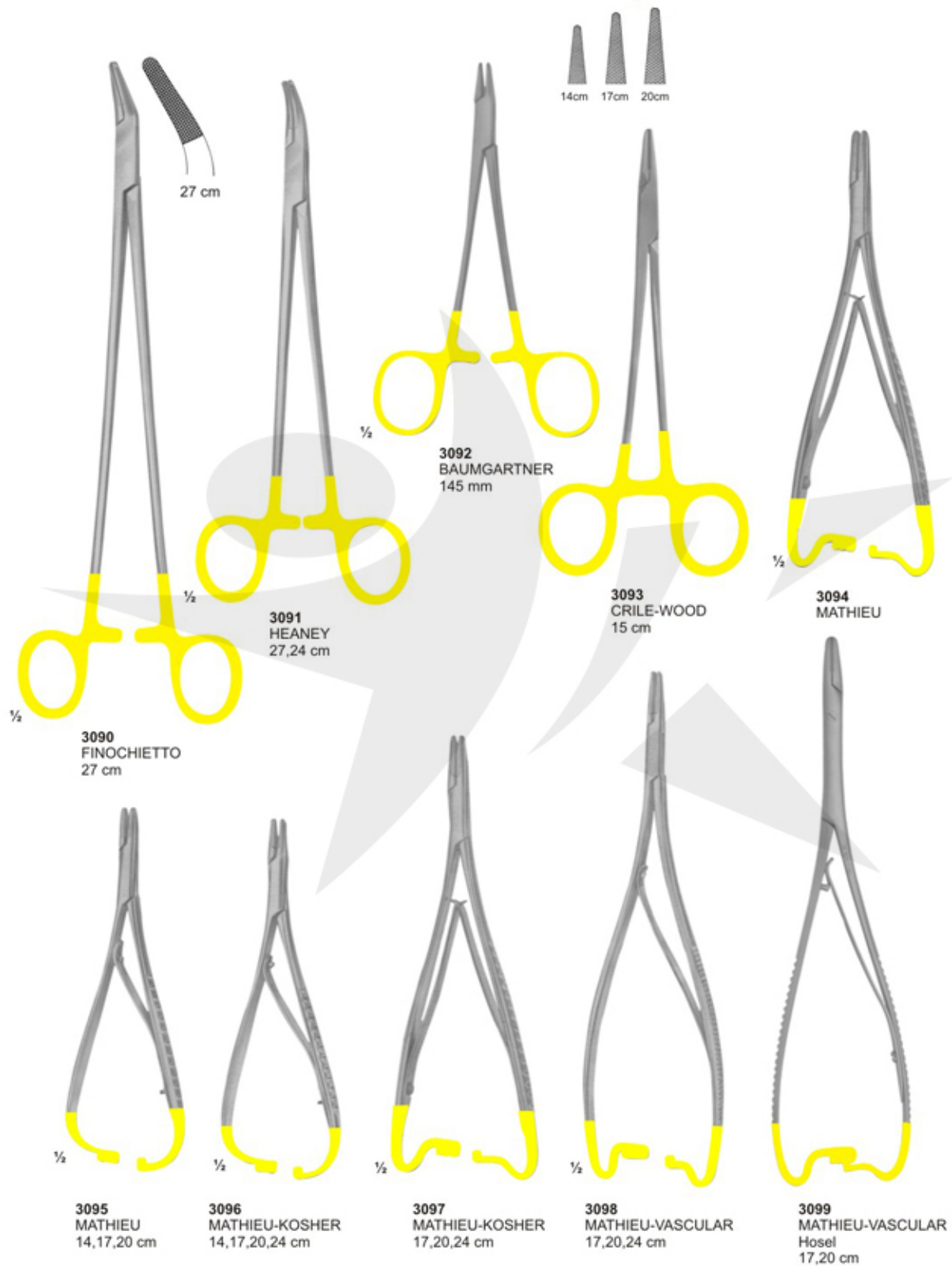



Needle Holders With T.C. Inserts

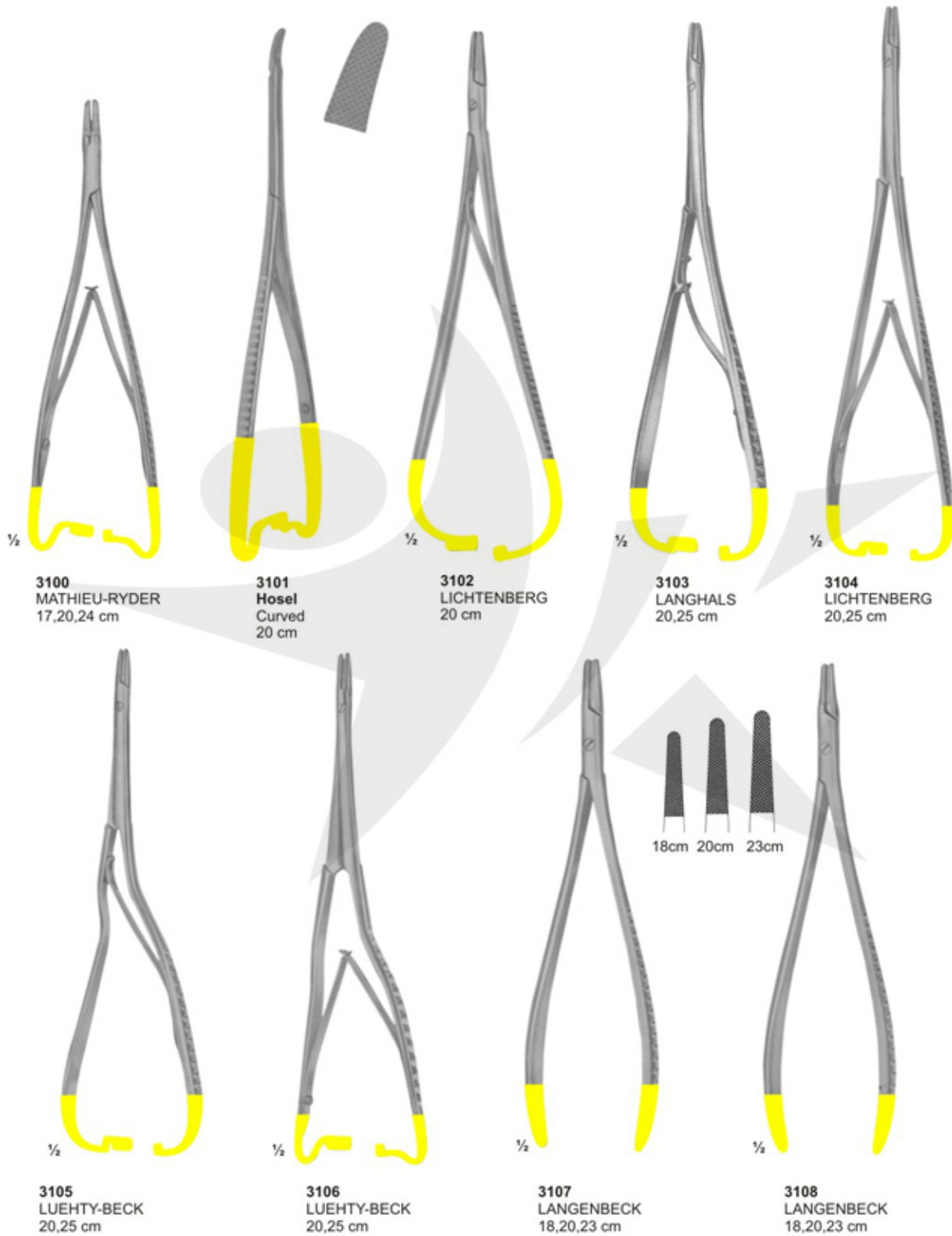



Wire Cutting Plier With T.C. Inserts



3109
TOENNIS
Elastic pattern for
dura-or intestinal suture
180 mm



3110
Cutting Plier
12 cm



3111
MULLAR CLAUS
22 cm



3112
Plier
17.5 cm



Dental Implants Instruments



3201
Root Elevator



3202
Root Elevator



3203
Osteotomes
Pointed



3204
Osteotomes
Pointed



3205
Osteotomes Convex
Rounded Set of Five



3206
Luxator Set 7 Pcs

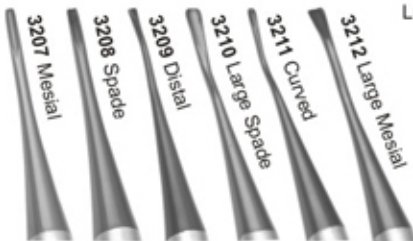

3213
Periodontal chisel
5mm / 3mm



3214
Sinus lift # 1
Set of Five

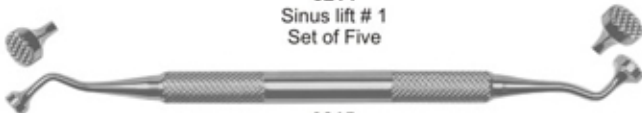

3215
Large Bone Packer
Serrated 5mm 7mm



3216
Labanca



3217
Sinus lift instruments



3218
Sinus lift instruments



3219
Replacement blade bone scraper
(curved) Three Type



3220
Adjustable-angle
Scalpel Blade Handle



3221
Replacment Blade
Bone Screper (streight)



3222
Bone Tamper 4mm
Searted Tip



3223
Bone Chisel



3224
Double Ended
Explorer



3225
Scaler



3226
Scaler



3227
Scaler



3228
Scaler



Dental Implants Instruments

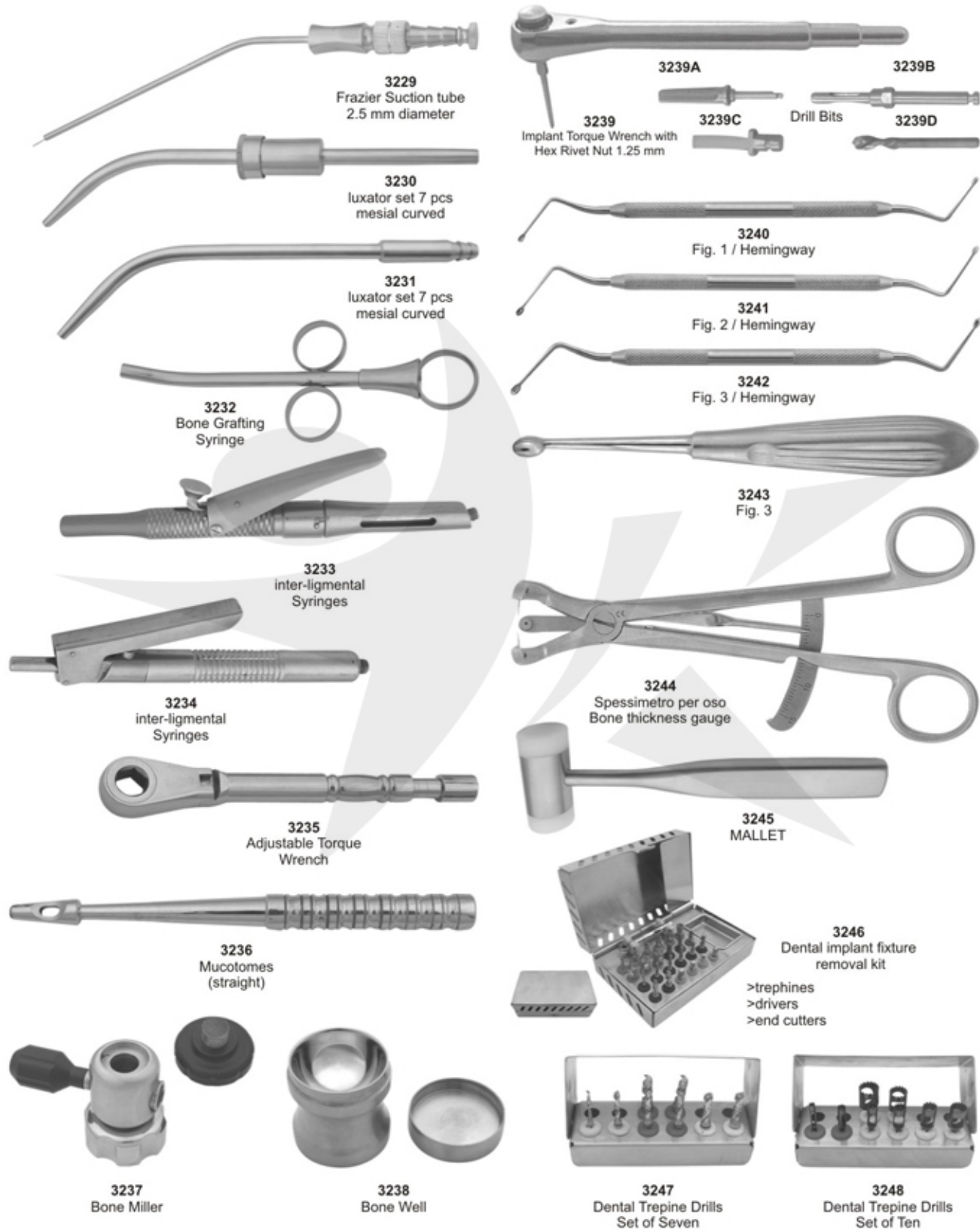



Dental Implants Instruments

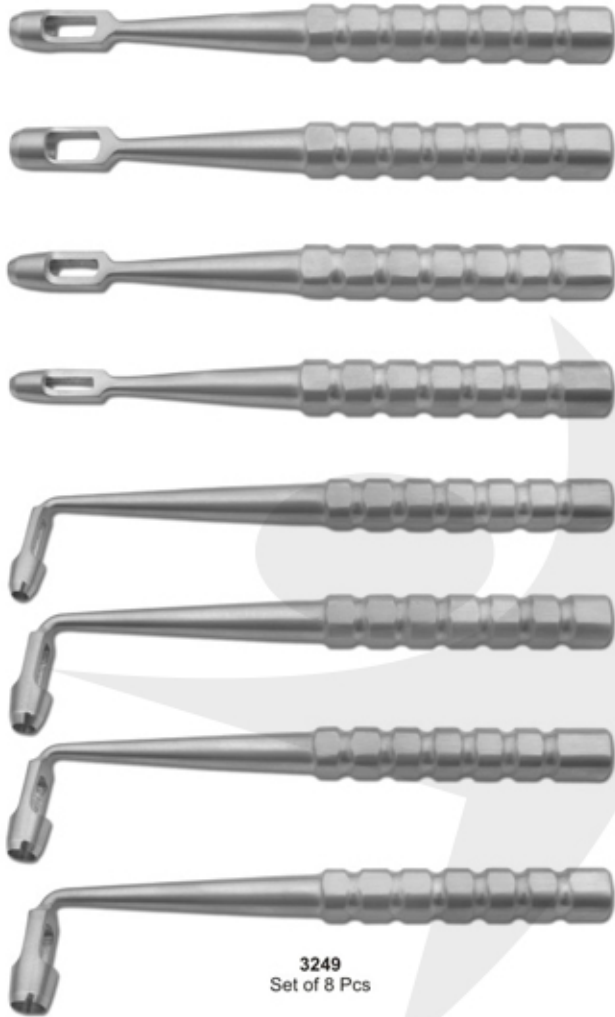

3249
Set of 8 Pcs



3251
Set of 5 Pcs



3250
Set of 5 Pcs

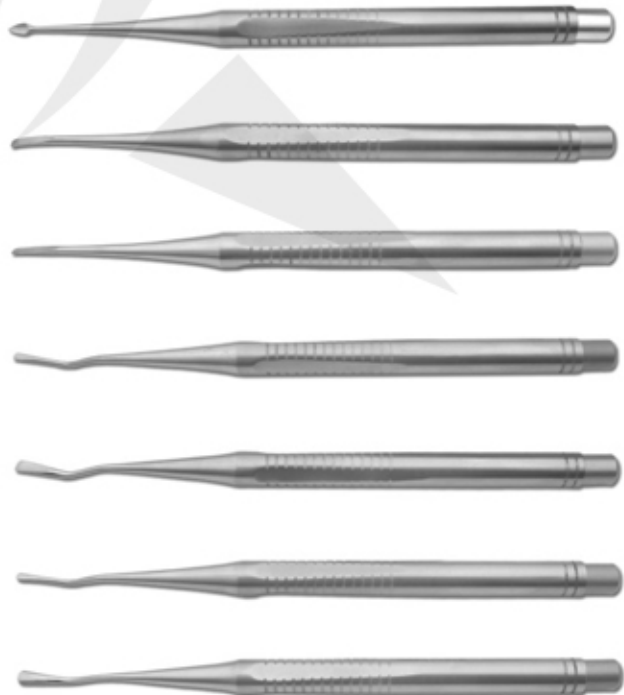

3252
Set of 7 Pcs



Dental Instruments Sets



3253
Tooth Extracting Forceps Kit (Set of 12 pcs)
Fig #: 1,7,13,17,18,51A,67A,73,74N,86,89,90



3254
Pedo Forceps Kit (Set of 7 pcs)
Fig #: 560,561,562,563,565,566,567



3255
Root Elevators Kit (Set of 9 pcs)
A) Cross Bar Elevator #775/7
B) Cross Bar Elevator # 775/8
C) Elevator, Str. Hospital Pattern (Semi-Pointed)
D) Elevator-Coupland Back Crurver #2 (Lindoleven)
E) Elevator # 720/10
F) Elevator # 120/11
G) Elevator # 720/27
H) Elevator # 720/28



3256
Oral Surgical Instruments Kit
A) B.P. Handle # 3 - Round, Str.
B) Artery Forceps, Str. 5.5"
C) Needle Holder, Str. 6"
D) Gum Scissors # 1
E) Gum Scissors # 2
F) Moons Probe, (Flat Beak)
G) Bone Curettes # 780 (Lucas)
H) Bone Nibbler, Large with Hole
J) Peristal Elevator



3257
Crown Remover Set
Full Automatic



3258
Rubber Dam
Instruments Set



3259
Gracey Curettes, (Set of 8 pcs)
Fig # 1/2,3/4,5/6,7/8,9/10,
11/12,13/14,15/16



3260
Subgingawal Scalers
(Set of 8 pcs S/E)



3261
Titanium Coated Filling Instruments
Hollow Handle (Set of 6 pcs)



3262
Titanium Coated Filling Instruments
(Set of 6 pcs)



Alphabetical Index

A			
Adams, Pliers	174		
Aderer, Pliers	174		
Adson, Forceps	158,207		
Adson, Tweezers	151		
Ainsworth, Rubber Dam Punch	147		
Albee	143		
Albrecht, Tweezers	155		
Allen, Tweezers	155		
Allis, Tissue Forceps	158		
Amalgam Applicators	97		
Amalgam Condensers	97		
Amalgam Pluggers	97		
Amalgam Carriers	145		
Amalgam Guns	145		
Andresen, Pliers	175		
Andrews, Tongue Depressor	160		
Angle, Pliers	169,174		
Apical, Elevator	57,63		
Arruga, T.C. Needle Holder	208,209		
Articulators	194-195		
Aspirating Syringes	149		
Allen 9A, Elevator	50		
B			
Baby-Allis, Tissue Forceps	158		
Band Removing Pliers	170		
Bane, Rongeurs	179		
Barnhart, Curettes	110,116		
Barry, Elevator	66,69		
Baum Gartner, Needle Holder	180,211		
Bee Be, Scissors	186		
Bein, Elevator	54,61		
Beyer, Rongeurs	179		
Bird Beak Pliers	167		
Blumenthan, Rongeurs	176		
Boley Gauge	143		
Bone Curettes	129		
Boynton, Needle Holder	181		
Bozemann-Wertheim, T.C. Needle Holder	210		
Bracket, Pliers	170		
Brewer, Rubber Dam Instruments	147		
Brown, Tissue Forceps	158		
Brown-Adson, Tissue Forceps	158		
Bruns, T.C. Scissors	203		
Buchs, Retractor	162		
Burnishers	99-100		
Ball Chain	146		
Boley Gauge,	143		
Bone Gauge,	144		
Bone Mill Forcep,	139		
Bone Pluggers,	140		
Bracket, Gauge	144		
Buser, Elevator	52		
C			
Carvers	102,103		
Castroviejo, Needle Holder	181,208,209		
Castroviejo, scissors	186		
Castroviejo, Gauge	144		
Castroviejo, Sclerer Marker	144		
Cement Instruments	118,119,121		
Cement Spatulas	120,122		
Chisels	103		
Chompret, Elevator	63		
Cleveland, Rongeurs	177,178		
College, Tweezers	152,154		
Collier, Needle Holder	180		
Collin, Retractor	162		
Columbia, Curettes	110,111,116		
Composite Placement	104,105		
Con Scodellino, Wax Knives	126		
Cord Packers	95		
Cottle, Scissors	184		
Coupland, Elevator	58		
Crane-Kaplan	128		
Crile, Forceps	157		
Crile, Needle Holder	181		
Crile-Wood, Needle Holder	180		
Crown Instruments	135,136		
Crown Removers	134,135		
Crown Shell, Pliers	166		
Cryer, Elevator	55,58,69		
Cushing , T.C. Forceps	207		
Cushing, Tweezers	151		
Cushing-Taylor , T.C. Forceps	207		
D			
De Bakey , T.C. Forceps	207		
De Bakey, Scissors	184,186,206		
De Bakey, T.C. Needle Holder	209		
De La Rosa, Pliers	169		
Deaver, Scissors	184		
Denhart, Mouth Gag	160		
Dental Implants Instruments	214,216		
Dental Instruments Sets	217		
Derf, Needle Holder	180		
Disposable Products	117		
Dr.Sader, Elevator	69		
Dressing Forceps	207		
Dean Scissors	186,205		
E			
Elevators	51		
Endodontic Condensers	86,87		
Emert, Wax Knives	126		
Excavators	89-91		
Explorers	80-82,91-94		
Extracting forceps (American Pattern)	36-49		
Extracting forceps (English Pattern)	1-24		
Extracting forceps (fitting handle)	25-33		
Extracting forceps (For Children)	34		
F			
Fahnenstock, Wax Knives	126		
Files	125		
Filling Instruments	106,107		
Fine, T.C. Scissors	206		
Finochietto, T.C. Needle Holder	211		
Finochietto, T.C. Needle Holder	211		
Fischer, Pliers	175		
Flagg, Tweezers	154		
Flohr, Elevator	56		
Fomon, Tissue Retractor	164		
Freer, Elevator	52		
Friedman, Rongeurs	178		
Furrer, Pliers	174		
Film Hanger	146		
Finger Cup	197		
Flohr, Elevator	57		
Freer	15,16		



Alphabetical Index

Elevator	52	Langenbeck, Retractor	162
G		Langenbeck, T.C. Needle Holder	212
Gardner, Bone Chisels	132	Langer, Currettes	110,116
Gardner, Needle Holder	180	Langhals, T.C. Needle Holder	212
Gardner, Rongeurs	178	Lecluse, Elevator	65
Gillies, Hook	164	Lessmann, Wax Knives	126
Gillies, Tweezers	151	Lexer, T.C. Scissors	202
Goldman Fox , T.C. Scissors	206	Lichtenberg, T.C. Needle Holder	212
Goldman Fox, Currettes	112,113	Ligature , T.C. Scissors	207
Goldman Fox 14, Elevator	50	Lip & Cheek Retractors	161,162
Goldman Fox, knives	114	Lister, Scissors	184
Goslee, Pliers	175	Littauer, Scissors	186
Gracey Currettes	108,109,116	Little, Scissors	184
		Locklin, Scissors	186
		London Hospital, Elevator	62
		London-College, Tweezers	154,155
		Lucae, T.C. Forceps	
		Luehty-Beck, T.C. Needle Holder	212
		Lwanson, Crown Gauge	143
		Lagrange, Scissors	186,205
		Littauere, Scissors	186
		Lwanson, Crown Gauge	143
		M	
H		Martin, T.C. Needle Holder	210
Halsey, T.C. Needle Holder	209	Mathieu, Needle Holder	181,211
Handles	72	Mathieu-Kosher, T.C. Needle Holder	211
Hartman, Rongeurs	179	Mathieu-Ryder, T.C. Needle Holder	212
Hatchets	95	Mathieu-Vascular, T.C. Needle Holder	211
Heaney, T.C. Needle Holder	211	Mayo Harrington, T.C. Scissors	205
Hegar, T.C. Needle Holder	209	Mayo, Scissors	185,204
Hegar-Vascular, T.C. Needle Holder	209	Mayo-Hegar, Needle Holder	181
Heidbrink, Elevator	64,67,69	Mayo-Hegar, T.C. Needle Holder	209
Heidbrink, Elevator	57	Mayo-Lexer, T.C. Scissors	202
Howard 9H, Elevator	52	Mayo-Stille, T.C. Scissors	202
Height Gauge,	143	Mayo-Stille Scissors	185
Hepp-Scheidle, T.C. Needle Holder	208	Mc Kellops, Pliers	175
Hlasted-Mosquito, Forceps	159	Mccalls, Currettes	110,111,116
Hoes	95,125	Mcindoe, Tweezers	151
Hollow Wares	196-200	Mead, Bone Mallets	133
How, Pliers	167,174	Mead, Elevator	64
Howard, Bone Files	131	Mead, Rongeurs	179
Hysin, Elevator	61	Meriam , T.C. Forceps	207
		Meriam, Tweezers	153,155
		Metzenbaum Fino, T.C. Scissors	203,204
I		Metzenbaum, Scissors	185,203
Implants Instruments	137-141	Micro Surgery Set	182
Impression Trays	187-193	Micro-Adson, Tweezers	151
Iris Scissors	183	Micro-Friedman, Rongeurs	178
Ivory, Rubber Dam Instruments	147	Middledorpf Retractor	162
		Miller, Articulating Forceps	147
		Miller, Bone Files	130
		Mini-Blumenthan, Rongeurs	176
J		Molt, Elevator	50
Jarabak, Pliers	165	Molt, Mouth Gag	160
Jeseoph, Scissors	183	Molt 9, Elevator	50
Johnson, Pliers	169,175	Morrison, Elevator	56
Joseph, Tissue Retractor	164	Mouth Mirrors with Handles	73
		MSY, Pliers	175
		Mullar Claus, Wire Cutting Pliers T.C.	213
		N	
K		Nance, Pliers	168,169,174
Kalt, T.C. Needle Holder	208	Napkin Holders	146
Kelly, Forceps	159	Neivert, Needle Holder	180
Kelly, Scissors	183	Nelson-Metzenbaum, Scissors	185
Kelly Scissors	205	Non Chill	146
Kim's Plier	165		
Kirkland, knife	114		
Knives	125		
Knowles, Scissors	184		
Kocher, Retractor	162		
Kocher-Langenbeck, Retractor	162		
Kopp, Elevator	60,68		
Kopp , Tweezers	151		
L			
Lab & Office Pliers	166		
Landgraf, Tweezers	154		
Langenbeck, Pliers	175		



Alphabetical Index

O

O'Brien, Pliers	168
Obturation Instruments	88
Ochsenbein	128
Ordan, knife	114
Oehler, T.C. Forceps	208
Olsen-Hegar, Needle Holder	180
Optical Pliers	168
Orthodontic Cutters, T.C.	172
Orthodontic Distal & Cutters	173
Orthodontic Pliers, T.C.	171
Ott, Elevator	62

P

Parametrium, T.C. Scissors	205
Partsch, Bone Chisels	133
Partsch, Bone Mallet	133
Pean, Forceps	157
Peeso, Pliers	166,175
Peets, Forceps	157
Perry, Tweezers	151
P.K. Thomas,	9696
Pich,	9898
Pluggers,	9898
Prichard, Elevator	5050
Plastic Handle Elevators	70
Polokoff, Bone File	131
Pott, Elevator	51
Potts-Smith, T.C. Forceps	208
Potts-Smith, T.C. Needle Holder	208
Probes	82-85,91,94

Q

Quinby, Scissors	183
------------------	-----

R

Ragnell , T.C. Scissors	206
Retainers, Bands	146
Reynolds, Pliers	169,174
Root Planning Curettes	115
Root splinter forceps	35
Roux, Retractor	162
Rubber Dam Clamps	148
Rubber Dam Holder	147
Rule, Curette	110
Russian, Tissue Forceps	158
Ryder, T.C. Needle Holder	210
Ryder-Vascular, T.C. Needle Holder	210

S

Sarot, T.C. Needle Holder	210
Scalers	75-79
Scalpel Handles	71
Schwarz, Pliers	168,175
Schluger, File	114
Seldin, Elevator	50,55,67
Select, Tweezers	151
Semken, T.C. Forceps	207
Semkin, Tissue Forceps	158
Senn, Tissue Retractor	164
Separating Pliers	166
Sims, T.C. Scissors	205
Spatulas	123
Spencer, Scissors	186
Spencer-Wells, Forceps	157

Spreaders	87
Split Chisels,	128
Spring Bow Divider	143
Standard, T.C. Scissors	201
Standard, Tweezers	151
Steiner, Pliers	166
Sterilizing & Lab Instruments	156
Sterilizing Forceps,	163
Stevens, Needle Holder	181
Stevens, Scissors	183
Stille, Scissors	185
Stratte, T.C. Needle Holder	210
Strip Holder Clips	146
Syringes	150
Suction Tubes,	140,142
Sugarman, File	114

T

Toennis, Wire Cutting Pliers T.C.	213
Toennis-Adson, Scissors	184
Toennis, Tissue Retractor	164
Towel Clamps, Napkin Holders	159
Tweed, Pliers	168
Telescope, Crown Plier	136
Traymann, Crown Remover	128

U

Universal , T.C. Scissors	207
Universal, Pliers	174
Universal, Elevator	135
Utility Plier	165

V

Vernier, Measuring Instruments	143
Vernier Gauge	143

W

Wakefield, Bone Chisels	132
Waldron, Pliers	174
Waldsachs, Pliers	174
Wangensteen, T.C. Forceps	208
Warwick-James, Elevator	62
Waugh, Tweezers	151
Wax & Modeling Carvers	120
Wax & Plaster Knives	127
Wax Carvers	101
Wax, Porcelain Instruments	118,119,121
Webster, Needle Holder	180,209
Weingart , Utility Pliers	167
Weitlaner, Retractor	160
West, Elevator	50
White, Rubber Dam Instrument	147
Wieder, Tongue Depressor	160
Winter, Elevator	65,69
Wire & Clasp Bending Pliers	170
Wire Bending Pliers	166
West, Elevator	50
Wire Cutter	165
Woodson,	98

Y

Young, Pliers	168,174
---------------	---------

Z

Zuricher, Measuring Instrument	143
Zuricher, Gauge	143



Wazirabad Road, P.O. Kotli Behram Pacca Garha Sialkot-3 Pakistan.

Phone: +92 312 777 26 77

Email: sasindustry51@gmail.com / Email: info@sas-industry.com

<http://www.sas-industry.com>